

Applications	Automotive Grade
Feature	<div style="display: flex; flex-direction: column; gap: 5px;"> <div>AEC-Q200 AEC-Q200</div> <div>Wire Wound Wire Wound</div> <div>Shield Magnetic Shield</div> <div>Ferrite Core Ferrite Core</div> </div>
Series Type	CLF-D
Status	Production
Brand	TDK

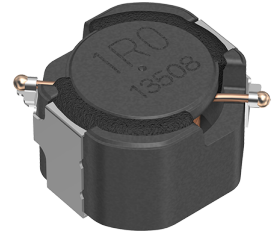

Size	
Length(L)	7.20mm ±0.20mm
Width(W)	6.90mm ±0.20mm
Thickness Height	4.50mm ±0.30mm
Recommended Land Pattern (A)	2.00mm Nom.
Recommended Land Pattern (B)	3.90mm Nom.
Recommended Land Pattern (C)	2.20mm Nom.

Electrical Characteristics	
Inductance	220µH ±20% at 100kHz
Rated Current (L Change) [Typ.]	620mA (10% Down)
Rated Current (L Change) [Max.]	
Rated Current (Temperature Rise) [Typ.]	520mA (30°C Rise)
Rated Current (Temperature Rise) [Max.]	
DC Resistance [Typ.]	660mΩ
DC Resistance [Max.]	792mΩ
Self Resonant Frequency [Min.]	
Self Resonant Frequency [Typ.]	
Q [Min.]	
Q [Typ.]	

Other	
Operating Temp. Range (Including Self-Temp. Rise)	-40 to 150°C
Soldering Method	Reflow Iron Soldering
AEC-Q200	YES
Packing	Punched (Paper)Taping [330mm Reel]
Package Quantity	1000pcs
Weight	0.8g

! Images are for reference only and show exemplary products.
! This PDF document was created based on the data listed on the TDK Corporation website.
! All specifications are subject to change without notice.

Characteristic Graphs(This is reference data, and does not guarantee the products characteristics.)

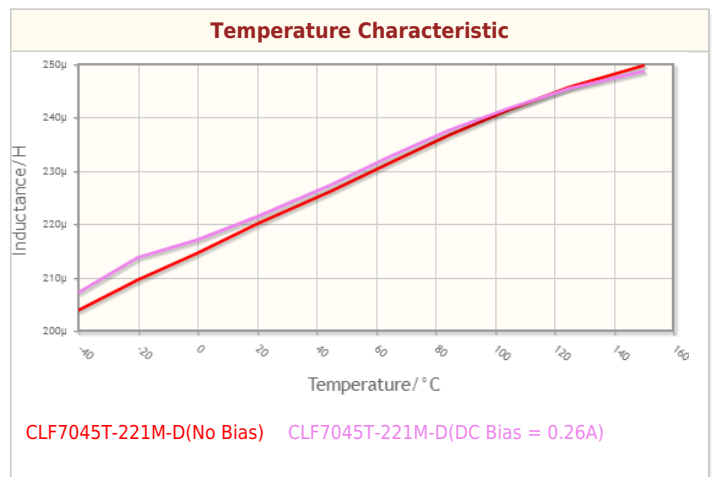
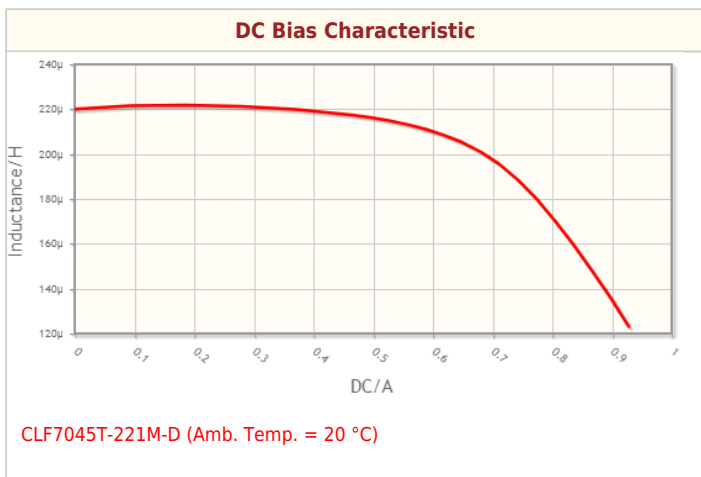
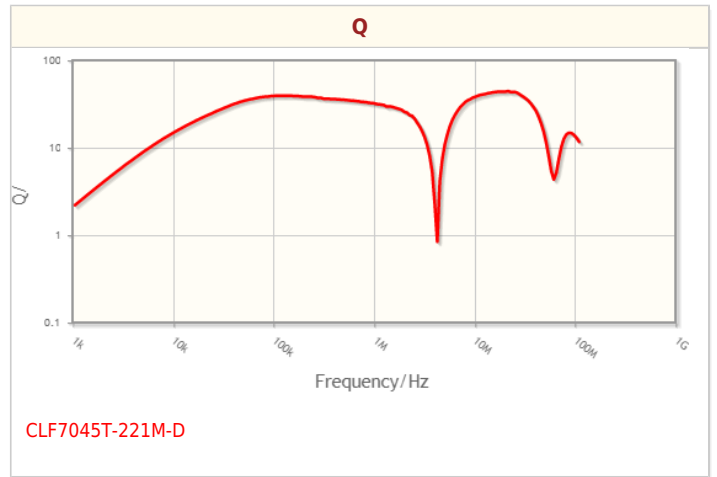
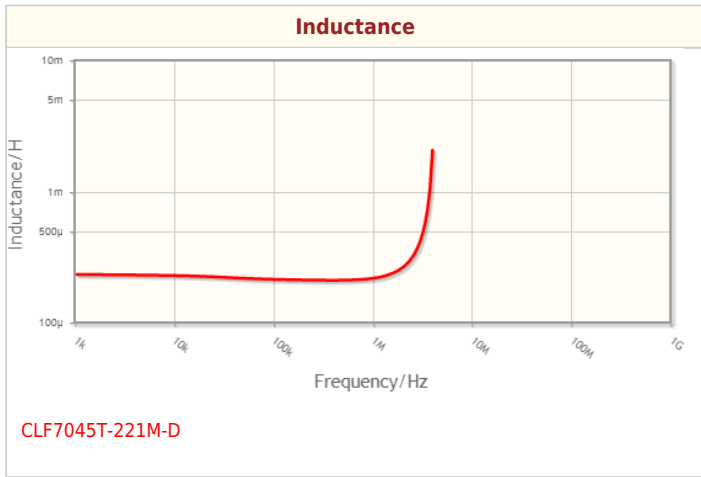
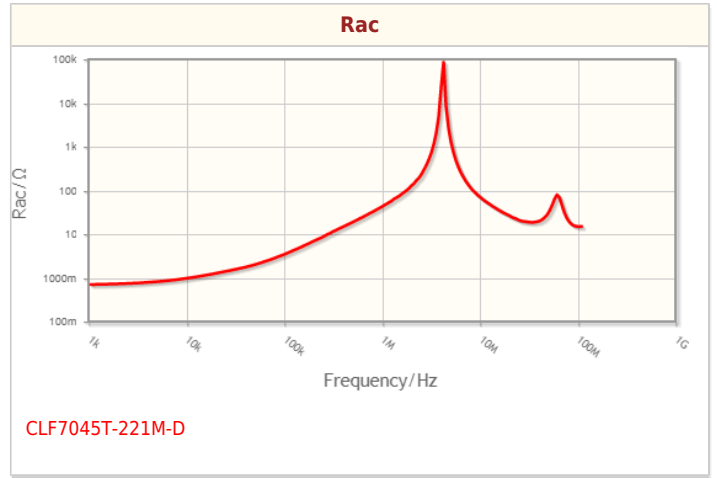
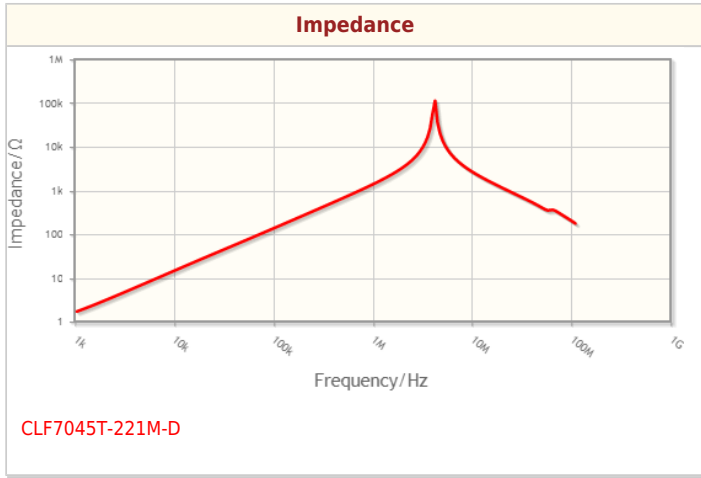

! Images are for reference only and show exemplary products.
! This PDF document was created based on the data listed on the TDK Corporation website.
! All specifications are subject to change without notice.

Characteristic Graphs(This is reference data, and does not guarantee the products characteristics.)

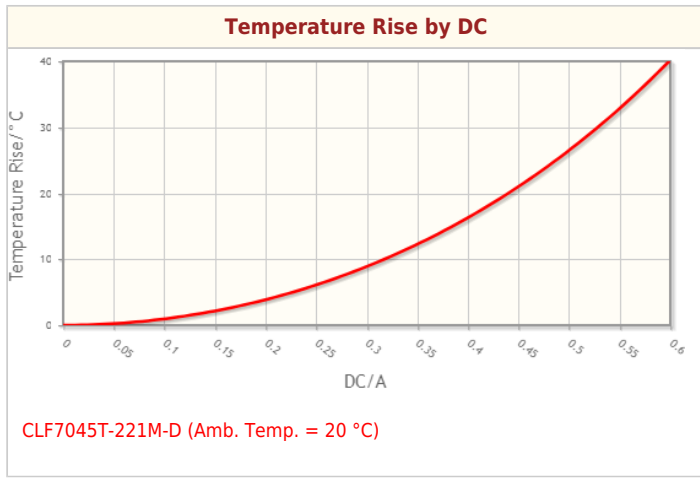

! Images are for reference only and show exemplary products.

! This PDF document was created based on the data listed on the TDK Corporation website.

! All specifications are subject to change without notice.

Copyright(c) TDK Corporation. All rights reserved.

Downloaded from [Arrow.com](https://arrow.com)

Associated Images

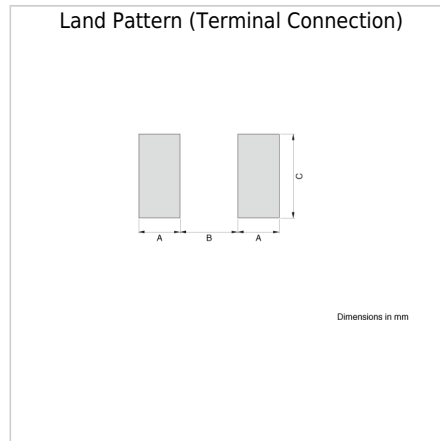
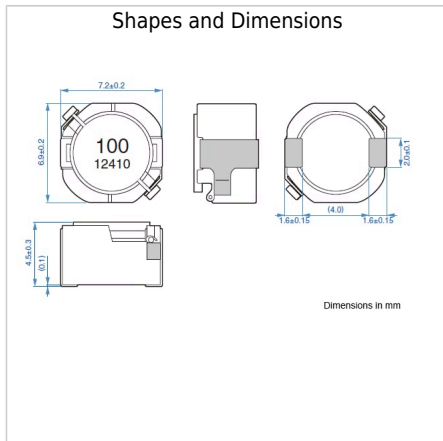

! Images are for reference only and show exemplary products.

! This PDF document was created based on the data listed on the TDK Corporation website.

! All specifications are subject to change without notice.

Copyright(c) TDK Corporation. All rights reserved.