

**SC3035B-1**

**800.0 MHz  
Differential  
Sine-Wave Clock**

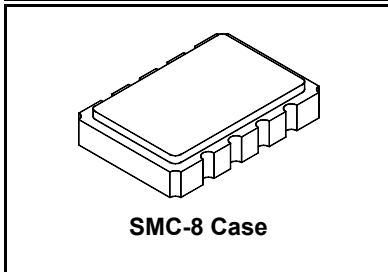

- Quartz SAW Frequency Stability
- Fundamental Fixed Frequency
- Very Low Jitter and Power Consumption
- Rugged, Miniature, Surface-Mount Case
- Low-Voltage Power Supply (3.3 VDC)

This digital clock is designed for use with high-speed timing systems. Fundamental-mode oscillation is made possible by surface-acoustic-wave (SAW) technology. The design results in low jitter, compact size, and low power consumption. Differential outputs provide a sine wave that is capable of driving 50 Ω loads.

**Absolute Maximum Ratings**

Rating	Value	Units
Power Supply Voltage (V <sub>CC</sub> at Terminal 1)	0 to +4.0	VDC
Input Voltage (ENABLE at Terminal 8)	0 to +4.0	VDC
Case Temperature (Powered or Storage)	-40 to +85	°C

**Electrical Characteristics**

Characteristic		Sym	Notes	Minimum	Typical	Maximum	Units	
Output Frequency	Absolute Frequency	f <sub>O</sub>	1, 2	799.800		800.200	MHz	
	Tolerance from 800.000 MHz	Δf <sub>O</sub>					±250	ppm
Q and Q̄ Output	Voltage into 50Ω (VSWR ≤ 1.2)	V <sub>O</sub>	1, 3	0.60	.85		V <sub>P-P</sub>	
	Operating Load VSWR					2:1		
	Symmetry		3, 4, 5	49		51	%	
	Harmonic Spurious		3, 4, 6		-25	-20	dBc	
	Nonharmonic Spurious					-60		
Q and Q̄ Period Jitter	No Noise on V <sub>CC</sub>		3, 4, 6, 7		15	30	ps <sub>P-P</sub>	
	200 mV <sub>P-P</sub> from 1 MHz to 1/2 f <sub>O</sub> on		3, 4, 7, 8			35	ps <sub>P-P</sub>	
Output (Disabled)	Amplitude into 50 Ω		3, 9			75	mV <sub>P-P</sub>	
Output DC Resistance (between Q & Q̄)			3	50			KΩ	
ENABLE (Terminal 14)	Input HIGH Voltage	V <sub>IH</sub>	3, 9	V <sub>CC</sub> -0.1	V <sub>CC</sub>	V <sub>CC</sub> +0.1	V	
	Input LOW Voltage	V <sub>IL</sub>		0.0		0.20	V	
	Input HIGH Current	I <sub>IH</sub>				3	5	mA
	Input LOW Current	I <sub>IL</sub>					-1	mA
	Propagation Delay	t <sub>PD</sub>					1	ms
DC Power Supply	Operating Voltage	V <sub>CC</sub>	1, 3	+3.13	+3.30	+3.47	VDC	
	Operating Current	I <sub>CC</sub>			20	40	mA	
Operating Ambient Temperature		T <sub>A</sub>	1, 3	0		+70	°C	
Lid Symbolization (YY = Year, WW = Week)	RFM SC3035B-1 800.00 MHz YYWW							



**CAUTION: Electrostatic Sensitive Device. Observe precautions for handling.**

**NOTES:**

- Unless otherwise noted, all specifications include any combination of load VSWR, V<sub>CC</sub>, and T<sub>A</sub>. In addition, Q and Q̄ are terminated into 50 Ω loads to ground. (See: Typical Test Circuit.)
- One or more of the following United States patents apply: 4,616,197; 4,670,681; 4,760,352.
- The design, manufacturing process, and specifications of this device are subject to change without notice.
- Only under the nominal conditions of 50 Ω load impedance with VSWR ≤ 1.2 and nominal power supply voltage.
- Symmetry is defined as the pulse width (in percent of total period) measured at the 50% points of Q or Q̄. (See: Timing Definitions.)
- Jitter and other spurious outputs induced by externally generated electrical noise on V<sub>CC</sub> or mechanical vibration are not included. Dedicated external voltage regulation and careful PCB layout are recommended for optimum performance.
- Applies to period jitter of Q and Q̄. Measurements are made with the Tektronix CSA803 signal analyzer with at least 1000 samples.
- Period jitter measured with a 200 mV<sub>P-P</sub> sine wave swept from 1 MHz to one-half of f<sub>O</sub> at the V<sub>CC</sub> power supply terminal.
- The outputs are enabled when Terminal 8 is at logic HIGH. Propagation delay is defined as the time from the 50% point on the rising edge of ENABLE to the 90% point on the rising edge of the output amplitude or as the fall time from the 50% point to the 10% point. (SEE: Timing Definitions.)
- The start up time is defined as the time from when power is applied to terminals 1 and 8 (90% of 3.3V) until power out from Q and Q̄ reaches 90% of Qout level.

## Electrical Connections

Terminal Number	Connection
1	V <sub>CC</sub>
2	Ground
3	NC or Ground
4	Q Output
5	$\bar{Q}$ Output
6	Ground
7	
8	ENABLE
LID	Ground

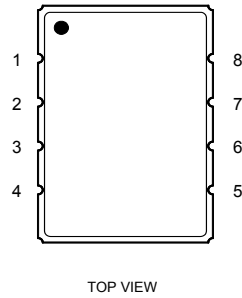

## Case Design

All pads consist of 30 microinches (min) electroless gold on 50 microinches (min) electroless nickel over base metal. The metallic center pad was designed for mechanical support. Grounding of this pad is optional.

Lid symbolization, including terminal 1 locator dot, are in contrasting ink. Symbolization varies by model number. For purposes of illustration, only terminal 1 dot is shown.

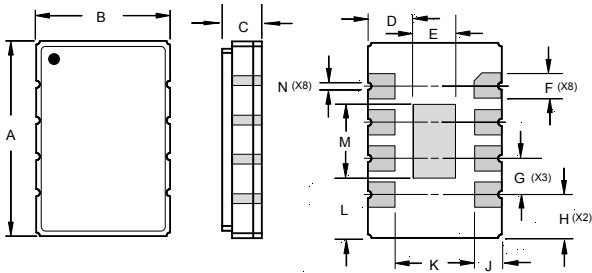

## Footprint

Actual size footprint:



## Typical Printed Circuit Board Land Pattern

A typical land pattern for a circuit board is shown below. Grounding of the metallic center pad is optional.

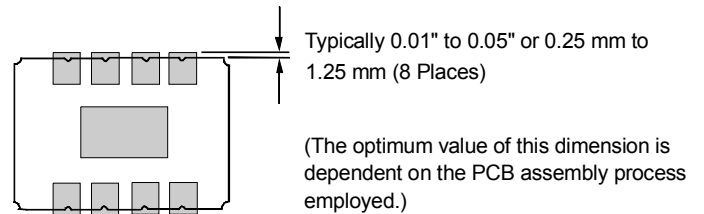

## Typical Test Circuit

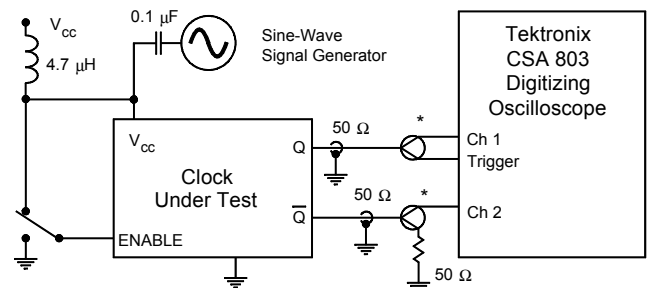

\*Power Splitter, Mini-Circuits ZFSC2-4

## Timing Definitions

### Propagation Delay:

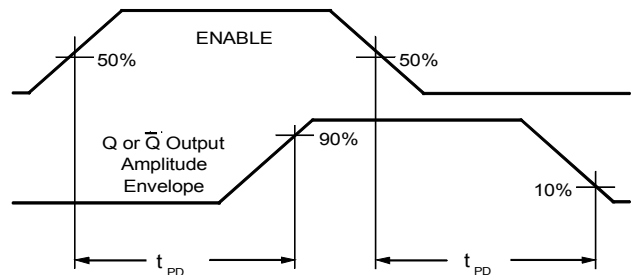

### Symmetry:

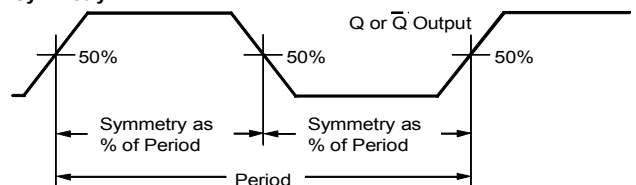

Dimensions	Millimeters		Inches	
	Min	Max	Min	Max
A	13.46	13.97	0.530	0.550
B	9.14	9.66	0.360	0.380
C	2.05 Nominal		0.081 Nominal	
D	3.56 Nominal		0.141 Nominal	
E	2.24 Nominal		0.088 Nominal	
F	1.27 Nominal		0.050 Nominal	
G	2.54 Nominal		0.100 Nominal	
H	3.05 Nominal		0.120 Nominal	
J	1.93 Nominal		0.076 Nominal	
K	5.54 Nominal		0.218 Nominal	
L	4.32 Nominal		0.170 Nominal	
M	4.83 Nominal		0.190 Nominal	
N	0.50 Nominal		0.020 Nominal	

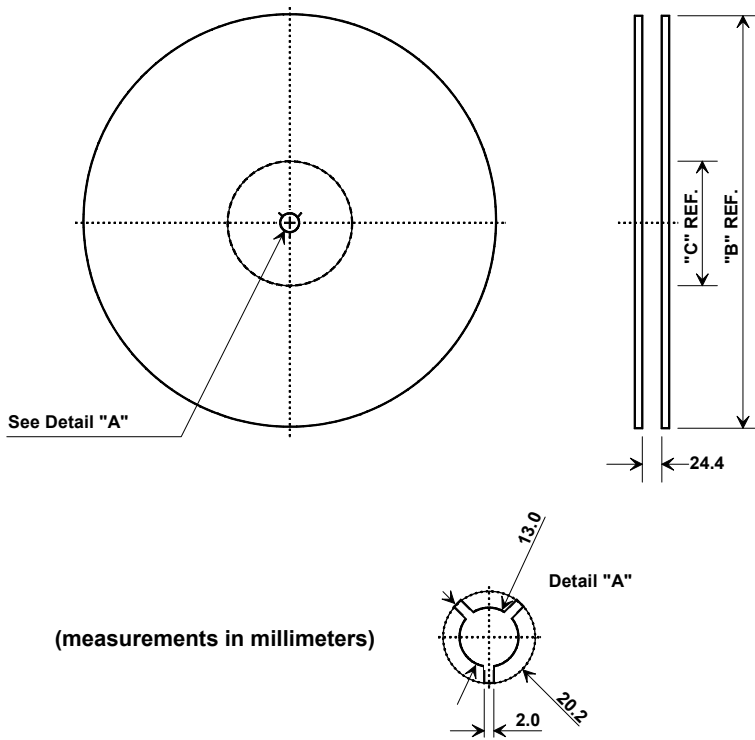

**SMC-08 Case**

Reel Size		Quantity Per Reel	
"B" Nominal	"C" Nominal	Min	Max
7 Inch	178 mm	200	500

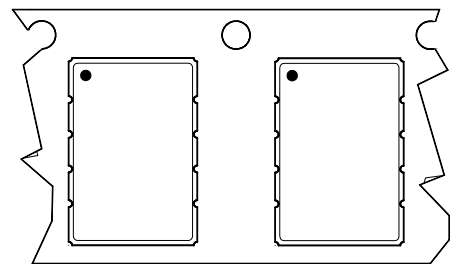

**Orientation in Tape Carrier as Shipped**

(measurements in millimeters)

**Dimensions**

Carrier Tape Dimensions		Cover Tape Size
<b>Ao</b>	.383 ± .004 (9.7)	21.3mm
<b>Bo</b>	.554 ± .004 (14.1)	
<b>Ko</b>	.130 ± .004 (3.3)	
<b>P</b>	12mm	
<b>W</b>	24mm	
<b>Tape Length</b>	60M	
<b>Pockets/M</b>	83/M	

