

LTC4359HDCB 28V/20A Ideal Diode and Switch with Reverse Input Protection

DESCRIPTION

Demonstration Circuit 1676A showcases the **LTC®4359** ideal diode controller with reverse input protection. The board includes two independent LTC4359 ideal diode circuits, sharing a common ground and operating over a 4.5V to 60V range. Each circuit comprises a load switch and ideal diode connected in series. Power to the load may be turned on and off by using the SHDN input, and the load is protected against reverse inputs of up to $-40V_{DC}$ by the ideal diode. In addition, input dropouts are blocked from the output, permitting capacitors or a battery to hold up the load when input power fails.

Each channel is capable of carrying 20A. Through-hole pads are included to permit modification for even higher currents, using an off-board power stage.

Design files for this circuit board are available at <http://www.linear.com/demo>

LT, LT, LTC, LTM, Linear Technology and the Linear logo are registered trademarks of Linear Technology Corporation. All other trademarks are the property of their respective owners.

PERFORMANCE SUMMARY Specifications are at $T_A = 25^\circ\text{C}$

PARAMETER	CONDITIONS	MIN	TYP	MAX	UNITS
Input Voltage Limits	Operating	4.5	28	60	V
	DC Survival	-40		75	V
	500ms Surge	-65		100	V
	$V_{IN} - V_{OUT}$	-100			V
Output Current Capability	$4.5V \leq V_{IN} \leq 8.5V$			10	A
	$8.5V < V_{IN} \leq 60V$			20	A

QUICK START PROCEDURE

Overview

DC1676A features two independent LTC4359 ideal diode and switch circuits sharing a common ground. Each channel handles up to 20A at room temperature, with no air flow. The board is double-sided. Reference designators are duplicated for the two sections of the board; the upper section is suffixed A while the lower section is suffixed B.

Voltage Capability and Onboard Clamps

The voltage capability of DC1676A is clearly stated on the top side silkscreen and on the schematic. Several factors contribute to the listed ranges. First, there are the limits of the LTC4359 which has a specified operating range of 4V to 80V, and an absolute maximum rating for the IN, $\overline{\text{SHDN}}$ and SOURCE pins of -40V to 100V .

Second, there is the 100V BV_{DSS} rating of MOSFET Q1 that limits the $V_{\text{IN}} - V_{\text{OUT}}$ rating of the board to -100V maximum.

Third, there are the clamp diodes D1 and D2. Clamping is necessary to rein in commutation spikes—the LTC4359 behavior is no different in this respect from ordinary rectifiers and switches.

Fourth, there is the dissipation capability of R1, a component which has been chosen for its pulse capability. It becomes the limiting factor for DC conditions when the input voltage exceeds the breakdown of D1 or D2. The pulse capability of R1 allows it to survive a -65V input for 500ms, or a -100V input for 30ms.

These factors combine to produce the Input Voltage Limits table shown on the schematic and silkscreened on to the circuit board. Always bear in mind the $V_{\text{IN}} - V_{\text{OUT}}$ limit of -100V which may further restrict the input range as a function of the output voltage. As an example, if the output voltage is held at 75V , Q1 will limit the maximum negative input to -25V before reaching breakdown.

Current Capability

DC1676A is designed to carry 20A per channel, limited by MOSFET, board and connector dissipation. In the input voltage range of 4.5V to 8.5V the current capability is

limited to 10A owing to reduced gate drive at low input voltage. Currents higher than 10A or 20A are permissible for short durations, limited by MOSFET ratings and thermal considerations. Initial production boards are erroneously marked 8V; the correct figure is 8.5V for all boards.

Circuit Resistances

Typical measured $R_{\text{DS(ON)}}$ at 10A for the IPB027N10N3G MOSFET is $2\text{m}\Omega$, dissipating about 800mW at 20A. If a single-point ground is used to avoid passing load current through the board's ground traces, the total board plus MOSFET loss is about 3.7W with both channels operating at 20A. MOSFET junction temperature rises about 40°C above ambient with the board lying on a bench top and deprived of air flow.

Banana plugs represent a substantial loss. The best banana test leads (such as Pomona Model B banana plug) are rated to only 10A to 15A. For this reason, and to minimize self-heating, all banana connections should be doubled up and kept as short as possible. The drop measured from the point where the wire exits a Pomona B-12 banana plug to the shoulder of the DC1676A banana jack is in excess of 20mV at 20A, or more than $1\text{m}\Omega$. If each of the eight banana jacks is used to carry 20A, the plugs themselves will contribute over 3W dissipation, not including a substantial dissipation in the wire.

If the turrets are removed, 12 AWG bus wire can be installed in the vacated holes to virtually eliminate any voltage drop or dissipation associated with connections to the board. The dissipation is reduced to about 20mW ($50\mu\Omega$) per connection. Use the banana jacks for Kelvin meter connections. At 20A even 12 AWG wire has its limitations: the resistance is $\approx 1.6\text{m}\Omega/\text{foot}$; one foot dissipates a surprising 640mW at 20A. Some of this heat is conducted into the circuit board.

Another means of making low resistance connections is to attach ring terminals or copper terminal lugs to the banana jacks, using 8-32 screws. A Blackburn/Thomas&Betts BTC1014 terminal lug, drilled out with a #15 drill, accepts up to 10 AWG stranded wire; BTC0614 accepts up to six AWG wire and needs no machining.

QUICK START PROCEDURE

Table 1 summarizes various circuit resistances and associated voltage and power losses.

ON/OFF Control

The LTC4359 may be turned on and off by placing the $\overline{\text{SHDN}}$ jumper in the ON or OFF position. In the OFF position the $\overline{\text{SHDN}}$ pin is connected to V_{SS} through $100\text{k}\Omega$ (R5), switch (Q2) is turned off, and the quiescent current is reduced to $\approx 14\mu\text{A}$. In the ON position the $\overline{\text{SHDN}}$ pin floats allowing an internal $2\mu\text{A}$ pull up to assert it high, enabling the LTC4359. If the input is higher than the output, Q1 and Q2 are driven on; otherwise they remain off until forward current flow is possible.

In the EXT position, the $\overline{\text{SHDN}}$ pin is connected through R5 to the $\overline{\text{SHDN}}$ turret. If the $\overline{\text{SHDN}}$ turret is left open, the LTC4359 is enabled. To turn off, connect the $\overline{\text{SHDN}}$ turret to the neighboring V_{SS} turret. $\overline{\text{SHDN}}$ pin level shift circuits are shown in data sheet Figure 3.

Because the $\overline{\text{SHDN}}$ pin is high impedance, it is subject to capacitive coupling. Pads are provided for an optional noise bypass capacitor, CF. R5 is included both for filtering and to help protect the $\overline{\text{SHDN}}$ pin against overvoltage conditions that might arise from use of the $\overline{\text{SHDN}}$ turret.

Load Limitations at Start-Up

Owing to its limited safe operating area (SOA), Q2 can be damaged if the output is heavily loaded at start-up. Start-up means activating the LTC4359 by abrupt application of power, or by asserting $\overline{\text{SHDN}}$ high. Figures 1, 2 and 3 show how much load can be supported at start-up, as a function of supply voltage for constant current, capacitive and resistive loads. The start-up capability is also a function of slew rate, which is set by C1 to 714V/s .

Figure 1 shows how much load current can be started, assuming that the load current is constant over the entire start-up interval. As an example, at 28V do not attempt to drag up a constant current load of more than 3.5A . Current capability increases in direct proportion to the square root of slew rate.

Load capacitors draw a constant current in direct proportion to output slew rate. Figure 2 shows how much load capacitance can be safely driven at start-up as a function of input voltage. The capacitance is proportional to the reciprocal of the square root of slew rate.

Resistive loads, probably more common in the lab than in application, are less stressful than constant current loads because the current for large values of V_{DS} is small, and V_{DS} is small for large currents. Figure 3 shows minimum permissible load resistance as a function of input voltage. As was the case for capacitive loads, the amount of resistance that can be safely started varies in proportion to the reciprocal of the square root of slew rate.

Figures 1, 2 and 3 apply for a P^2t of $160\text{W}^2\text{s}$, loads that are present right from the onset of start-up, $C1=10\text{nF}$, and account for the effect of MOSFET capacitance which slows the slew rate to approximately 714V/s . Each graph presumes that the loading is exclusive: there is no other loading at start-up other than that suggested in the graph. Each graph also presumes that the output voltage starts from zero, and is not held up by a diode-OR arrangement. Discontinuities in the graphs arise because the loading is sometimes limited by the maximum permissible load current of 10A over the 4.5V to 8.5V range and 20A over the 8.5V to 60V range, and in other cases limited by Q2's SOA.

Exact SOA analysis of a more complex loading situation, such as a mixture of constant current, resistive and capacitive loading, is best quantified by simulation on a case by case basis. SOA is not an issue at turn off as the fall time is less than 1ms , in contrast to the rise time which approaches 85ms at 60V .

Modifying for Higher Current

An off-board power stage may be constructed and connected to DC1676A by using the IN, OUT, SOURCE and GATE test pads, provided Q1, Q2, CSNUB and RSNUB are removed from the DC1676A circuit board (see Figure 4). Snub the off-board MOSFETs with a 100Ω , 10nF series

QUICK START PROCEDURE

network. The off-board Q2 must have a 10 Ω series resistor located at its gate lead, to prevent destructive parasitic oscillations. Keep the leads as short as possible, paying particular attention to GATE and SOURCE. Do not pass load current through the DC1676A ground terminals.

Modifying for Other Applications

Pads are provided for a $\overline{\text{SHDN}}$ pin filter capacitor, CF. This is useful for controlling the timing of ON/OFF signals, and for filtering noise if long wires are connected to the $\overline{\text{SHDN}}$ turret. Pads are also provided for D3, allowing the demo board to be modified to match certain data sheet applications.

How to Operate DC1676A

A simple demonstration of DC1676A's operation is as follows (see Figure 5). Connect two adjustable power supplies, each set to 28V. Connect one to VIN A and nearby GND, the second to VIN B and its associated GND. Place the $\overline{\text{SHDN}}$ jumpers in the ON position. Join together the outputs of VOUT A and VOUT B at the input of a DC load of up to 20A. Slowly adjust one power supply up and down relative to the other while monitoring the power supply currents. The higher supply will carry the load current, with a narrow transition region where the voltages are nearly identical and the supplies droop share. If one supply is shorted, the output voltage will not collapse—the other supply will carry the load.

Each channel can be individually controlled by its associated $\overline{\text{SHDN}}$ jumper. For example, if channel A is adjusted to 33V and channel B is set to 28V, channel A will supply the full load current. If channel A's $\overline{\text{SHDN}}$ jumper is subsequently set to OFF, channel A will turn off and the full load current will be provided by channel B. This, of course, assumes that the outputs VOUT A and VOUT B are connected together as described in the previous paragraph.

The forward characteristics of the LTC4359 can be tested without using a high power load and using only a low voltage 20A supply, as shown in Figure 6. First, bias DC1676A with a 28V supply. This supply provides quiescent current for the two channels, totaling less than 1mA. Second, connect the two channels in series (VOUT A connected to VIN B), and connect a 20A, current-limited low voltage (1V to 2V) supply to VIN A and VOUT B.

Turn on the two supplies. 20A will flow from the input of channel A, through Q2A and Q1A, to the input of channel B, through Q2B and Q1B, and back out to the 20A power supply. This arrangement eliminates the need for high-power supplies or a high power load, yet the forward behavior of the LTC4359 and the board, connector and MOSFET voltage drops can be examined as though the board was fully loaded with each channel carrying 20A.

The 20A supply may be adjusted from zero to 20A and the 28V supply may be adjusted from 8.5V to 60V, to observe operation under any condition. At 10A, the 28V supply may be adjust to as low as 4.5V.

QUICK START PROCEDURE

Table 1. Various Voltage Drops Measured at 10A Load Current

Path	Measured Drop at 10A (mV)	Computed Resistance ($\mu\Omega$)	Computed Dissipation at 20A (mW)
Banana Plug Tip to Banana Jack Shoulder	5.0	500	200
Banana Plug Tip to Banana Jack Shoulder Treated with DeoxIT	3.0	300	120
MOSFET Drain Lead to Source Lead	19.9	1990	796
Q2 Source Lead to Q1 Source Lead	4.2	420	168
Input Turret to Output Turret	46.3	4630	1852
Input Banana Tip to Output Banana Tip	—	6100	2440
Channel A Input Ground to Output Ground	4.4	440	176
Channel B Input Ground to Output Ground	3.6	360	144
12 AWG Solid Tinned Bus Wire in Turrent Hole	0.5	50	20
12 AWG Bus Wire, 12" Long (2mm \times 305mm)	16	1600	640
Pomona B-12 Banana Patch Cord Wire Loss	74	7400	2960
Pomona B-24 Banana Patch Cord Wire Loss	140	14000	5600

QUICK START PROCEDURE

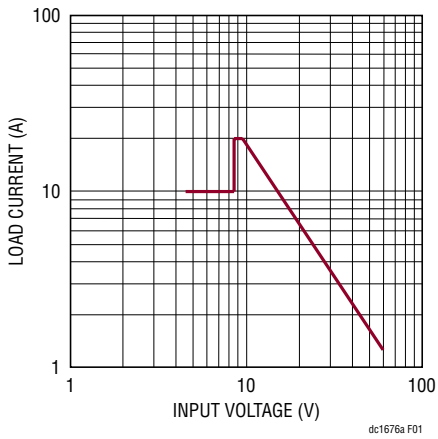

Figure 1. Maximum Permissible Constant Current Load at Start-Up

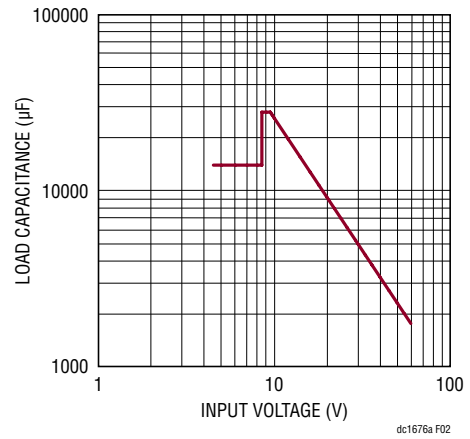

Figure 2. Maximum Permissible Load Capacitance at Start-Up

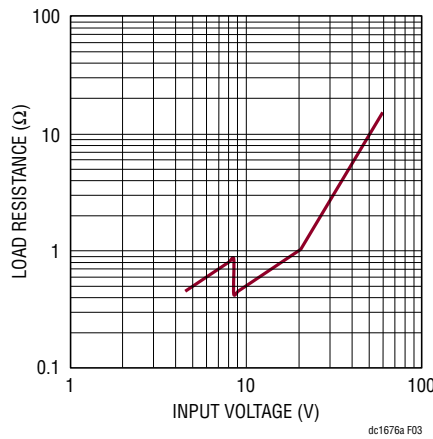

Figure 3. Minimum Permissible Load Resistance at Start-Up

QUICK START PROCEDURE

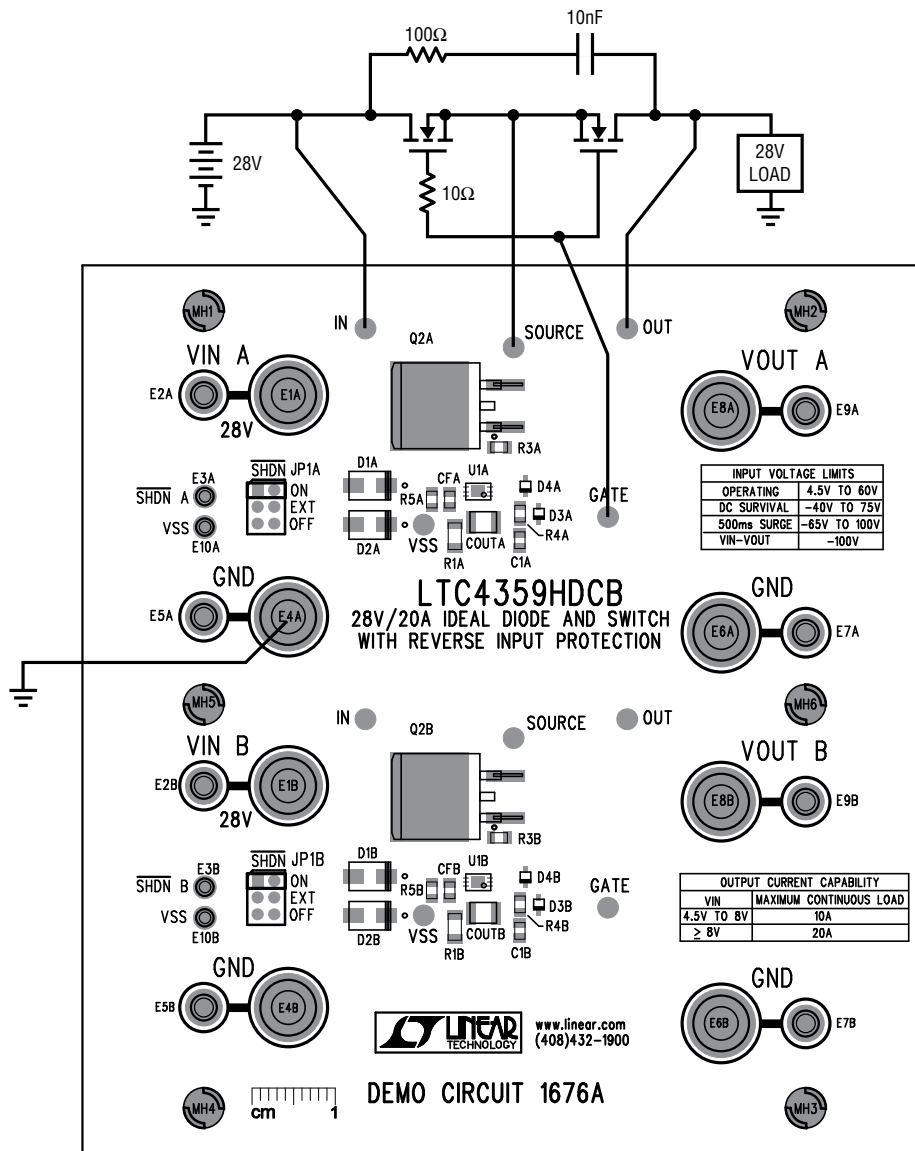

Figure 4. Driving an Off-Board Power Stage. Remove Q1, Q2, RSNUB and CSNUB (See Schematic Diagram)

DEMO MANUAL DC1676A

QUICK START PROCEDURE

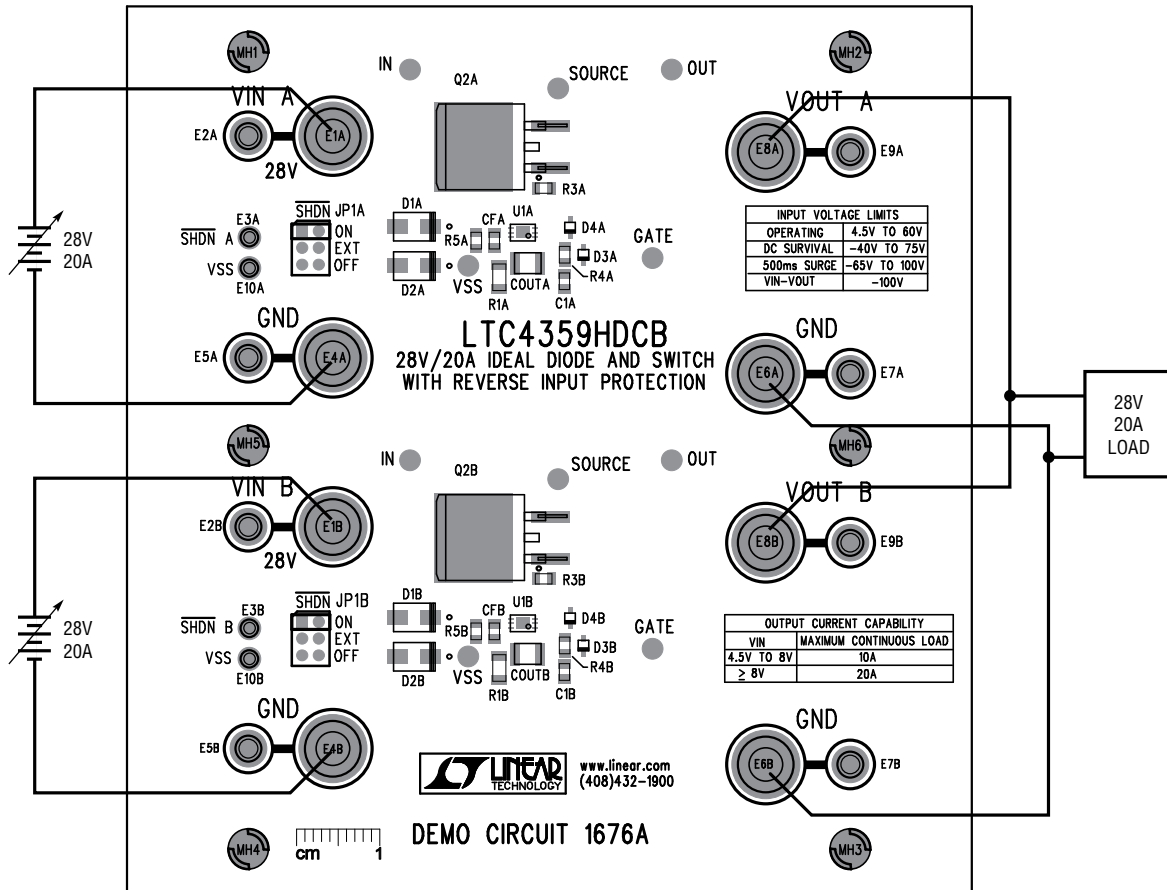

Figure 5. Basic Test Setup

QUICK START PROCEDURE

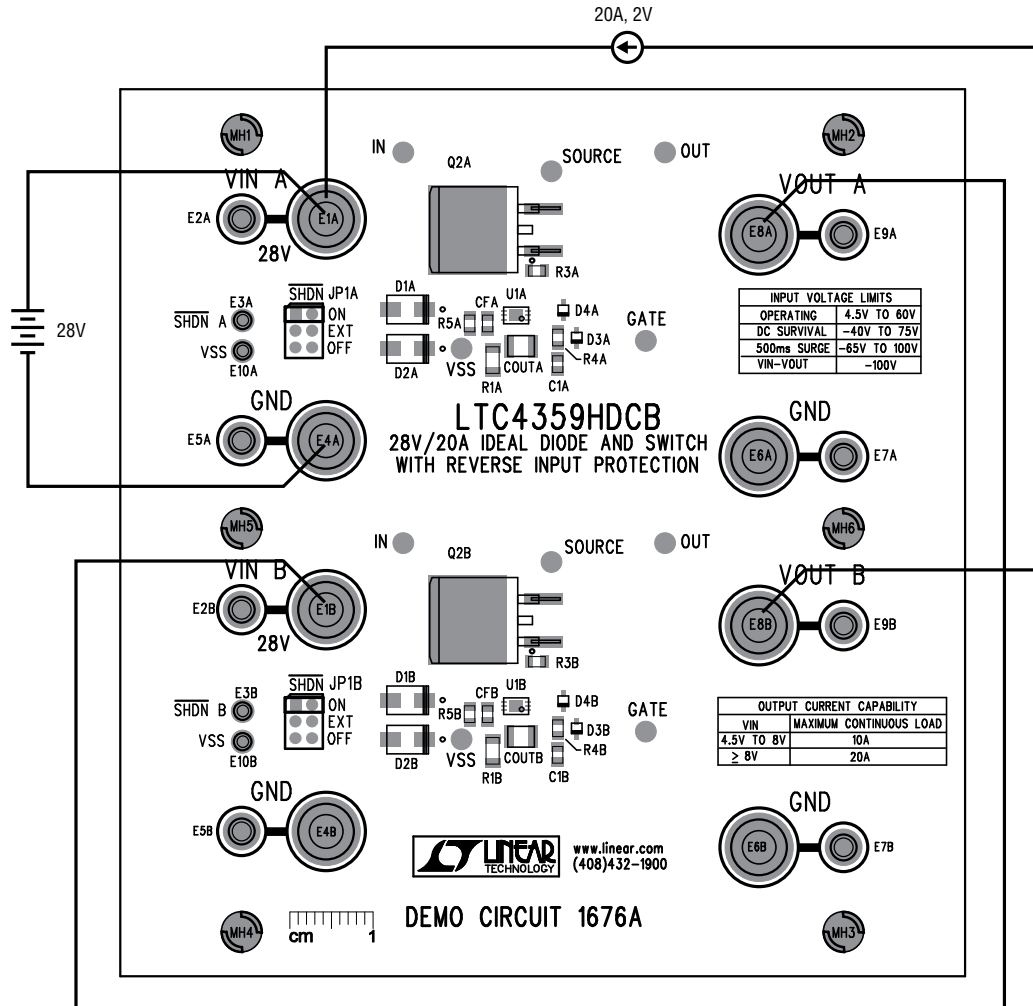

Figure 6. Testing Forward Drops without the Need for a High Power Supply or High Power Load.

DEMO MANUAL DC1676A

PARTS LIST

ITEM	QTY	REFERENCE	PART DESCRIPTION	MANUFACTURER/PART NUMBER
1	0	CFB, CFA	CAP, X7R, 10nF, 100V 20% 0805, OPTIONAL	AVX, 08051C103MAT2A
2	2	COU7B, COU7A	CAP, X7R, 2.2µF, 100V 10% 1210	MURATA, GRM32ER72A225KA35L
3	2	CSNUBB, CSNUBA	CAP, X7R, 10nF, 500V 20% 1206	AVX, 12067C103MAT2A
4	2	C1B, C1A	CAP, X7R, 10nF, 100V 20% 0805	AVX, 08051C103MAT2A
5	2	D1B, D1A	DIODE, TVS, 58V, SMA	DIODES INC/ZETEX, SMAJ58A-13-F
6	2	D2B, D2A	DIODE, TVS, 24V, SMA	DIODES INC/ZETEX, SMAJ24A-13-F
7	0	D3B, D3A	DIODE, SWITCHING, 250mA 300V, SOD-523, OPTIONAL	DIODES INC/ZETEX, BAS521-7
8	2	D4B, D4A	DIODE, ZENER 12V 150mW SOD-523	DIODES INC./ZETEX, DDZ9699T-7
9	8	E1B, E1A, E4B, E4A, E6B, E6A, E8B, E8A	BANANA JACK, NON-INSULATED	KEYSTONE, 575-4
10	8	E2B, E2A, E5B, E5A, E7B, E7A, E9B, E9A,	TEST POINT, TURRET, 0.094, PBF	MILL-MAX, 2501-2-00-80-00-00-07-0
11	4	E3B, E3A, E10B, E10A	TEST POINT, TURRET, 0.061, PBF	MILL-MAX, 2308-2-00-80-00-00-07-0
12	2	JP1B, JP1A	HEADER, 2mm x 3mm PIN, 0.079CC	SAMTEC, TMM-103-02-L-D
13	6	MH1 TO MH6	STANDOFF, NYLON 0.5"	KEYSTONE, 8833 (SNAP ON)
14	4	Q1B, Q1A, Q2B, Q2A	TRANSISTOR, MOSFET, N-CH, 100V 120A TO-263	INFINEON, IPB027N10N3 G
15	2	RSNUBB, RSNUBA	RES, CHIP, 100Ω, 1/2W, 5% 1210	VISHAY, CRCW1210100RJNEA
16	2	R1B, R1A	RES, CHIP, HIGH POWER, 1k, 1/2W, 5% 1206	VISHAY, CRCW12061K00JNEAHP
17	2	R3B, R3A	RES, CHIP, 10Ω, 1/8W, 5% 0805	VISHAY, CRCW080510R0JNEA
18	2	R4B, R4A	RES, CHIP, 10k, 1/8W 5% 0805	VISHAY, CRCW080510K0JNEA
19	2	R5B, R5A	RES, CHIP, 100k, 1/8W, 5% 0805	VISHAY, CRCW0805100KJNEA
20	2	U1B, U1A	IC, 28V IDEAL DIODE, DFN-6L	LINEAR TECHNOLOGY, LTC4359HDCB#PBF
21	2	XJP1A, XJP1B	SHUNT, 2mm	SAMTEC, 2SN-BK-G

SCHEMATIC DIAGRAM

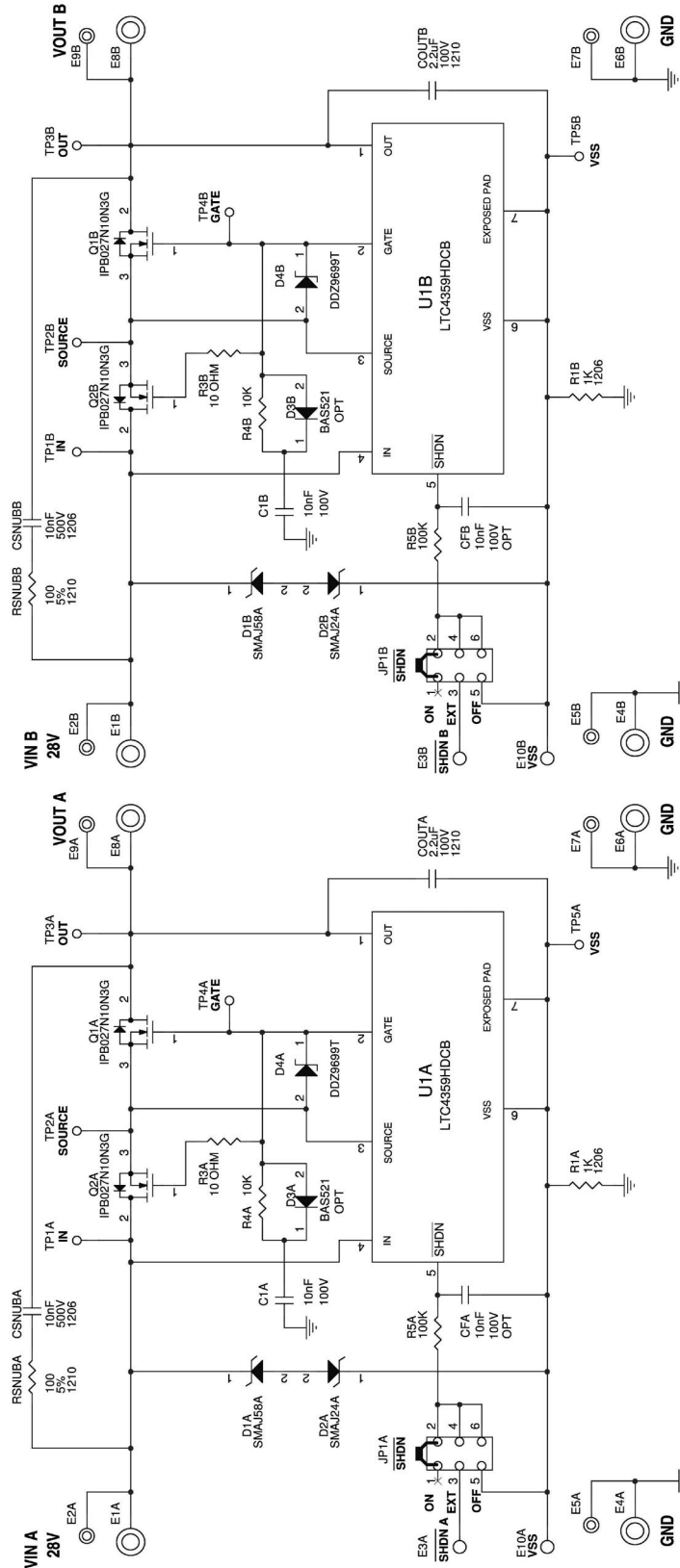

NOTE: LTC4359HDCB TOP MARK LFKF.

OUTPUT CURRENT CAPABILITY	
VIN	MAXIMUM CONTINUOUS LOAD
4.5V to 8V	10A
≥ 8V	20A

INPUT VOLTAGE LIMITS	
OPERATING	4.5V to 60V
DC SURVIVAL	-40V to 75V
500ms SURGE	-65V to 100V
VIN - VOUT	-100V

DEMO MANUAL DC1676A

DEMONSTRATION BOARD IMPORTANT NOTICE

Linear Technology Corporation (LTC) provides the enclosed product(s) under the following **AS IS** conditions:

This demonstration board (DEMO BOARD) kit being sold or provided by Linear Technology is intended for use for **ENGINEERING DEVELOPMENT OR EVALUATION PURPOSES ONLY** and is not provided by LTC for commercial use. As such, the DEMO BOARD herein may not be complete in terms of required design-, marketing-, and/or manufacturing-related protective considerations, including but not limited to product safety measures typically found in finished commercial goods. As a prototype, this product does not fall within the scope of the European Union directive on electromagnetic compatibility and therefore may or may not meet the technical requirements of the directive, or other regulations.

If this evaluation kit does not meet the specifications recited in the DEMO BOARD manual the kit may be returned within 30 days from the date of delivery for a full refund. **THE FOREGOING WARRANTY IS THE EXCLUSIVE WARRANTY MADE BY THE SELLER TO BUYER AND IS IN LIEU OF ALL OTHER WARRANTIES, EXPRESSED, IMPLIED, OR STATUTORY, INCLUDING ANY WARRANTY OF MERCHANTABILITY OR FITNESS FOR ANY PARTICULAR PURPOSE. EXCEPT TO THE EXTENT OF THIS INDEMNITY, NEITHER PARTY SHALL BE LIABLE TO THE OTHER FOR ANY INDIRECT, SPECIAL, INCIDENTAL, OR CONSEQUENTIAL DAMAGES.**

The user assumes all responsibility and liability for proper and safe handling of the goods. Further, the user releases LTC from all claims arising from the handling or use of the goods. Due to the open construction of the product, it is the user's responsibility to take any and all appropriate precautions with regard to electrostatic discharge. Also be aware that the products herein may not be regulatory compliant or agency certified (FCC, UL, CE, etc.).

No License is granted under any patent right or other intellectual property whatsoever. **LTC assumes no liability for applications assistance, customer product design, software performance, or infringement of patents or any other intellectual property rights of any kind.**

LTC currently services a variety of customers for products around the world, and therefore this transaction **is not exclusive**.

Please read the DEMO BOARD manual prior to handling the product. Persons handling this product must have electronics training and observe good laboratory practice standards. **Common sense is encouraged.**

This notice contains important safety information about temperatures and voltages. For further safety concerns, please contact a LTC application engineer.

Mailing Address:

Linear Technology
1630 McCarthy Blvd.
Milpitas, CA 95035

Copyright © 2004, Linear Technology Corporation

dc1676af