

LT1506 Monolithic 4A Switcher

5V to 15V Input

3.3V Output

DESCRIPTION

Demonstration circuits DC237/DC238 are complete DC/DC step-down regulators using the LT[®]1506, constant frequency, high efficiency converter in 7-pin DD (DC238) and SO-8 (DC237) packages. These circuits are primarily used in personal computers, disk drives, portable

handheld devices and, in larger systems, as local onboard regulators. High frequency switching allows the use of small inductors, making this all surface mount solution ideal for space conscious systems.

LT, LTC and LT are registered trademarks of Linear Technology Corporation.

PERFORMANCE SUMMARY

$T_A = 25^\circ\text{C}$, $V_{IN} = 12\text{V}$, $I_{LOAD} = 2\text{A}$, $V_{OUT} = 3.3\text{V}$, SHDN and SYNC pins open, unless otherwise specified.

| PARAMETER | CONDITIONS | MIN | TYP | MAX | UNITS |
|-------------------------|--------------------------------|------|------|------|-------------------|
| Output Voltage | (Note 1) | 3.23 | 3.3 | 3.42 | V |
| Maximum I_{LOAD} | (Note 2) | 4 | | | A |
| Input Voltage Range | | 4.5 | | 15 | V |
| Switching Frequency | | 460 | 500 | 540 | kHz |
| Output Ripple Voltage | | | 70 | | mV _{p-p} |
| Line Regulation | 5V to 15V | | 2 | | mV |
| Load Regulation | $I_{LOAD} = 10\text{mA}$ to 4A | | 14 | | mV |
| SHDN Lockout Threshold | | 2.3 | 2.38 | 2.46 | V |
| SHDN Shutdown Threshold | | 0.15 | 0.37 | 0.6 | V |
| Synchronization Range | DC237 Only | 580 | | 1000 | kHz |
| Supply Current | SHDN = 0V | | 20 | | μA |

Note 1: Output voltage variations include $\pm 1\%$ tolerance of feedback divider network. For tighter voltage range, use lower tolerance resistors or fixed 3.3V output device, LT1506-3.3.

Note 2: For DC237, additional thermal restrictions apply.

BOARD PHOTOS

DC237 Component Side



DC238 Component Side



TYPICAL PERFORMANCE CHARACTERISTICS

3.3V Output Efficiency

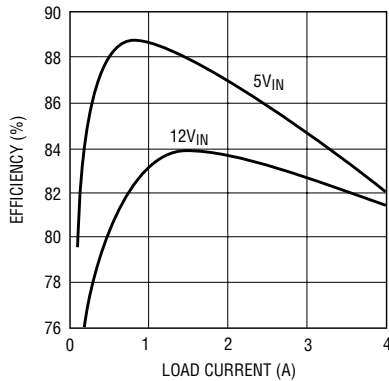

DC237/38TA01

Temperature Rise vs Load Current

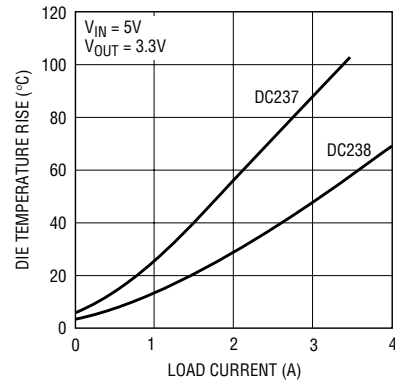

DC237/38TA02

PACKAGE AND SCHEMATIC DIAGRAMS

DC237

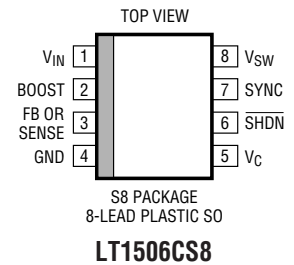
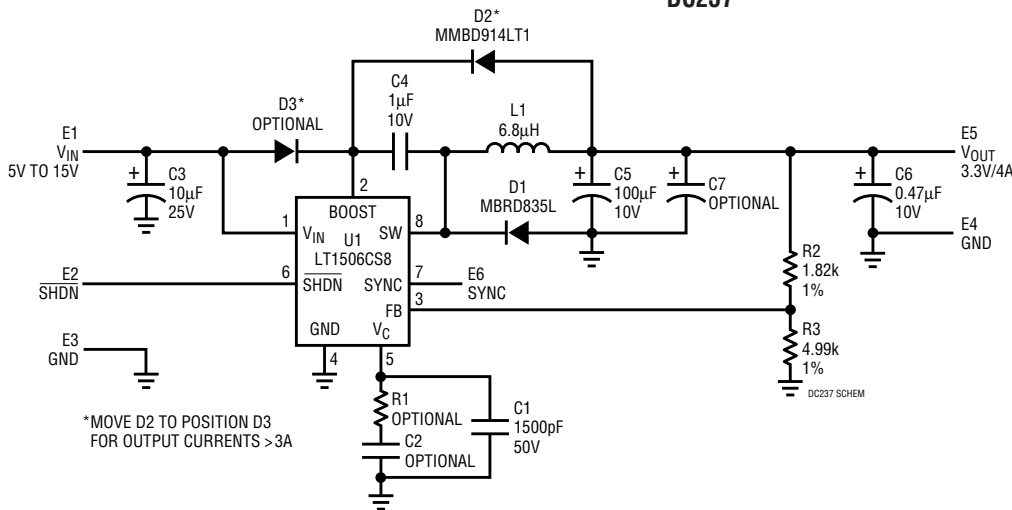

DC238

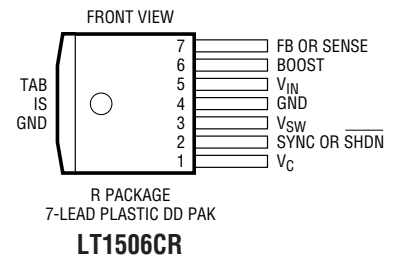
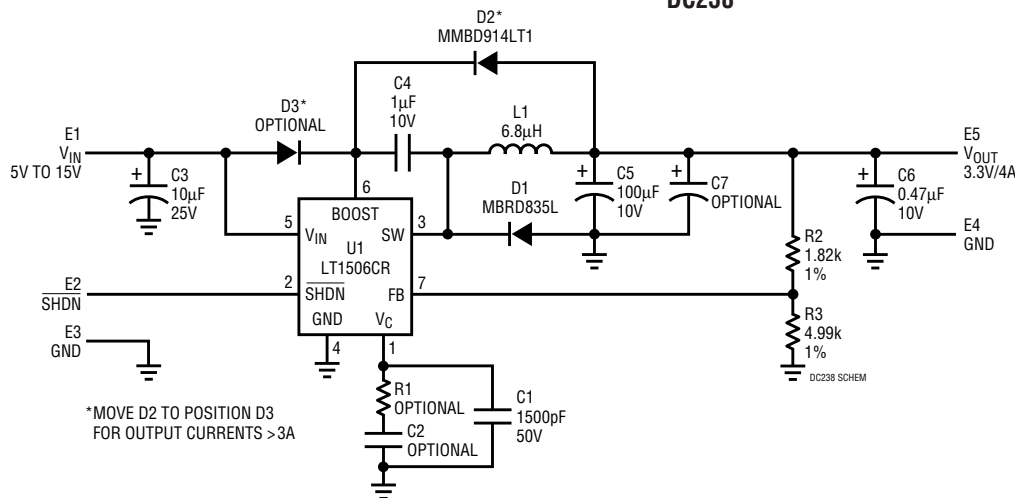

PARTS LISTS

DC237

| REFERENCE DESIGNATOR | QUANTITY | PART NUMBER | DESCRIPTION | VENDOR | TELEPHONE |
|----------------------|----------|------------------|----------------------------------|-----------|----------------|
| C1 | 1 | 08055C152MAT2S | 1500pF 50V X7R Chip Capacitor | AVX | (843) 946-0362 |
| C2 | 0 | | Optional Capacitor | | |
| C3 | 1 | GRM235Y5V106Z | 10µF 25V Y5V Chip Capacitor | Murata | (814) 237-1431 |
| C4 | 1 | 0805ZC105MAT2S | 1µF 10V X7R Chip Capacitor | AVX | (843) 946-0362 |
| C5 | 1 | TPSD107M010R0080 | 100µF 10V TPS Tantalum Capacitor | AVX | (207) 282-5111 |
| C6 | 1 | 0603ZG474MAT3S | 0.47µF 10V Y5V Chip Capacitor | AVX | (843) 946-0362 |
| C7 | 1 | | Optional Capacitor | | |
| D1 | 1 | MBRD835L | SMT Diode | Motorola | (800) 441-2447 |
| D2 | 1 | MMBD914LT1 | 1N914 Diode | Motorola | (800) 441-2447 |
| D3 | 1 | | Optional Diode | | |
| E1 to E6 | 6 | 2501-2 | Pad Turret | Mill-Max | (516) 922-6000 |
| R1 | 0 | | Optional Resistor | | |
| R2 | 1 | CR10-1821F-T | 1.82k 1/8W 1% Chip Resistor | Tad | (714) 255-9123 |
| R3 | 1 | CR10-4991F-T | 4.99k 1/8W 1% Chip Resistor | Tad | (800) 508-1521 |
| L1 | 1 | DO3316P-682 | 6.8µH 20% Inductor | Coilcraft | (847) 639-6400 |
| U1 | 1 | LT1506CS8 | SO-8 Linear IC | LTC | (408) 432-1900 |
| | 1 | DC237 | PCB | | |
| | 1 | DC237 Stencil | Stencil | | |

DC238

| REFERENCE DESIGNATOR | QUANTITY | PART NUMBER | DESCRIPTION | VENDOR | TELEPHONE |
|----------------------|----------|------------------|----------------------------------|-----------|----------------|
| C1 | 1 | 08055C152MAT2S | 1500pF 50V X7R Chip Capacitor | AVX | (843) 946-0362 |
| C2 | 0 | | Optional Capacitor | | |
| C3 | 1 | GRM235Y5V106Z | 10µF 25V Y5V Chip Capacitor | Murata | (814) 237-1431 |
| C4 | 1 | 0805ZC105MAT2S | 1µF 10V X7R Chip Capacitor | AVX | (843) 946-0362 |
| C5 | 1 | TPSD107M010R0080 | 100µF 10V TPS Tantalum Capacitor | AVX | (207) 282-5111 |
| C6 | 1 | 0603ZG474MAT3S | 0.47µF 10V Y5V Chip Capacitor | AVX | (843) 946-0362 |
| C7 | 1 | | Optional Capacitor | | |
| D1 | 1 | MBRD835L | SMT Diode | Motorola | (800) 441-2447 |
| D2 | 1 | MMBD914LT1 | 1N914 Diode | Motorola | (800) 441-2447 |
| D3 | 1 | | Optional Diode | | |
| E1 to E6 | 6 | 2501-2 | Pad Turret | Mill-Max | (516) 922-6000 |
| R1 | 0 | | Optional Resistor | | |
| R2 | 1 | CR10-1821F-T | 1.82k 1/8W 1% Chip Resistor | Tad | (714) 255-9123 |
| R3 | 1 | CR10-4991F-T | 4.99k 1/8W 1% Chip Resistor | Tad | (800) 508-1521 |
| L1 | 1 | DO3316P-682 | 6.8µH 20% Inductor | Coilcraft | (847) 639-6400 |
| U1 | 1 | LT1506CR | 7-Pin DD Pak Linear IC | LTC | (408) 432-1900 |
| | 1 | DC238 | PCB | | |
| | 1 | DC238 Stencil | Stencil | | |

OPERATION

DC237 vs DC238 (Temperature vs Package Size)

The DC237 and DC238 demonstration boards are intended for evaluation of the LT1506 switching regulator in the SO-8 and 7-pin DD packages respectively. The 7-pin DD package used in DC238 has no SYNC pin, but a version (LT1506CR-SYNC) replaces the SHDN function at Pin 2 with the SYNC function. The primary reason for choosing the SO-8 over the DD package is board space. The DC238 (DD package) occupies an active board area of approximately 0.75 square inches. Optimizing the DC237 board, using a Sumida coil and removing the layout options, a total active area of 0.4 square inches is possible. The DD package is more suitable for higher power or higher ambient temperature applications. Although both boards will supply 4A of output current, DC237 must be thermally derated to 3A continuous at 22°C ambient to prevent excessive die temperatures. DC238 can run at 60°C ambient at 4A output current. However, the SO-8 package can be used for dynamic loads up to the full rated switch current.

LT1506 Operation

The LT1506 data sheet gives a complete description of the part, operation and applications information. The data sheet should be read in conjunction with this demo manual.

Hook-Up

Solid turret terminals are provided for easy connection to supplies and test equipment. Connect a 0V to 15V, 4.5A power supply across the V_{IN} and GND terminals and the load across the V_{OUT} and GND terminals. When measuring load/line regulation, remember to Kelvin connect to the turrets. Also, when measuring output ripple voltage with an oscilloscope probe, the wire from the probe to the ground clip will act as an antenna, picking up excessive noise. For improved results, the test hook should be removed from the tip of the probe. The tip should be touched against the output turret, with the bare ground shield pressed against the ground turret. This reduces the noise seen on the waveform.

Shutdown

For normal operation, the SHDN pin can be left floating. SHDN has two output-disable modes: lockout and

shutdown. When the pin is taken below the lockout threshold, switching is disabled. This is typically used for input undervoltage lockout. Grounding the SHDN pin places the LT1506 in shutdown mode. This reduces total board supply current to 20 μ A.

Synchronization

Synchronization is Available on DC237 Only (SYNC is an Optional Replacement for SHDN on the DD Package). For normal demo board operation, the SYNC pin can be left floating. If unused in the application, it is advisable to tie this pin to ground. To synchronize switching to an external clock, apply a logic-level signal to the SYNC pin. The amplitude must be from a logical low to greater than 2.2V, with a duty cycle from 10% to 90%. The synchronization frequency must be greater than the free-running oscillator frequency and less than 1MHz. Additional circuitry may be required to prevent subharmonic oscillation. Refer to the LT1506 data sheet for more details.

COMPONENTS

Inductor L1

The inductor is a Coilcraft DO3316P-682, a 6.8 μ H unshielded ferrite unit. It was selected for its low cost, small size and 4.6A I_{SAT} rating. The equivalent Coiltronics UP2-6R8 unit can be substituted. If board space is at a premium and higher ripple current is acceptable, solder pads are available for the Sumida CD43-1R8 inductor. This 1.8 μ H unit has a 2.9A I_{SAT} rating. Ripple at 5V $_{IN}$ is ± 1.1 A. This gives a maximum output current of $(4.5A - 1.1A) = 3.4A$.

Input/Output Capacitors C3, C5, C6 and C7

The input capacitor C3 is a Tokin ceramic capacitor. It was selected for its small size, high voltage rating and low ESR (effective series resistance). The input ripple current for a buck converter is high, typically $I_{OUT}/2$. Tantalum capacitors become resistive at higher frequencies, requiring careful ripple-rating selection to prevent excessive heating. Ceramic capacitors' ESL (effective series inductance) tends to dominate their ESR, making them less susceptible to ripple-induced heating.

OPERATION

The output capacitor C5 is an AVX tantalum capacitor. A ceramic is not recommended as the main output capacitor since loop stability relies on a resistive characteristic at higher frequencies to form a zero. The AVX TPS series was specifically designed for switch-mode power supplies to have very low ESR. At switching frequencies, ripple voltage is more a function of ESR than of absolute capacitance value. If lower output ripple voltage is required, use the optional capacitor C7 to reduce ESR rather than increasing the capacitance of C5. For very low ripple, an additional LC filter in the output may be a less expensive solution. The output contains very narrow voltage spikes because of the parasitic inductance of C5. A small ceramic capacitor, C6, removes these spikes on the demo board. In application, trace inductance and local bypass capacitors will perform this function, negating the need for C6.

Catch Diode D1

Use diodes designed for switching applications, with adequate current rating and fast turn-on times, such as Schottky or ultrafast diodes. In selecting a diode, the basic parameters of interest are forward voltage, maximum reverse voltage, average operating current and peak current. Lower forward voltage yields higher circuit efficiency and lowers power dissipation in the diode. The MBRD835L has a maximum forward drop of 0.4V at 3A. The reverse voltage rating must be greater than the input voltage. Average diode current is always less than output current, but under a shorted output condition, diode current can equal switch current limit. If the application must withstand this condition, the diode must be rated for maximum switch current.

Compensation: C1, C2 and R1

A detailed discussion of frequency compensation can be found in the LT1506 data sheet. C1, a 1500pF capacitor from V_C to ground, gives a stable loop response over a wide range of input and output conditions. Options R1 and C2 are included for optimization of the dynamic response to a specific application.

Boost Voltage: D2, D3 and C4

A boost voltage of at least 2.8V is required throughout the on-time of the switch to guarantee that it remains saturated. At output currents greater than 3A and higher ambient temperatures, diode D2 must be moved to position D3 to prevent boost from falling below this minimum. For output voltages above 3.3V, diode D2 provides sufficient boost voltage to C4.

PCB LAYOUT

In many cases, the layout of the demonstration board may be dropped directly into the application with minimal changes. If not, there are several precautions that must be taken when laying out high frequency converter circuits. The high frequency switching path runs from ground, through C3, to the V_{IN} pin of the LT1506, out of the SW pin, through D1 and back to ground. This loop acts as an antenna and will radiate noise if not kept as short as possible. Also, at higher switching currents, the associated trace inductance can cause excessive voltage spikes across the switch. The use of a ground plane will reduce many noise problems. The ground pin of the LT1506 contains some high frequency signal currents, but more importantly, it is the 0V reference for the output voltage. Connect the ground pin directly to the ground plane. The FB and V_C components should be kept away from the power components as much as possible. The ground for these components should be separated from power grounds. Run a Kelvin sense to V_{OUT} as required but keep the divider network close to the LT1506 to prevent noise pickup on the FB node. Noise pickup on the V_C pin appears as various problems, including poor load regulation, subharmonic oscillation and instability. Thermal management must also be considered. The SO-8 package has a fused ground pin. Soldering this pin to a large copper area will significantly reduce its thermal resistance. Solder-filled feedthroughs close to the ground pin provide a good thermal path to the ground plane. For the DD package, the grounded tab should be treated in the same manner. For more information or advice, contact the LTC Applications department.

PCB LAYOUT AND FILM (DC237)

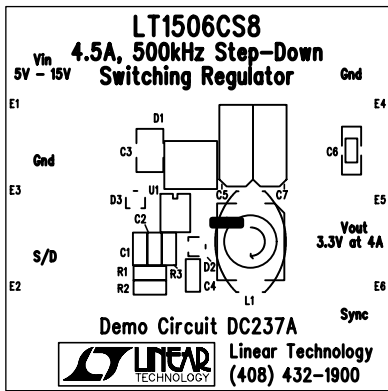

Component Side Silkscreen

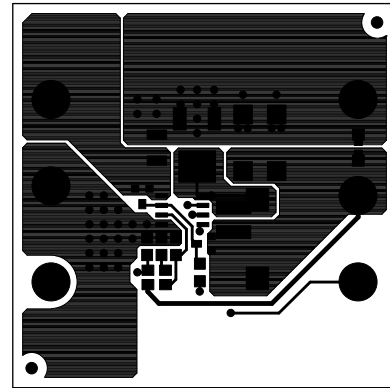

Component Side

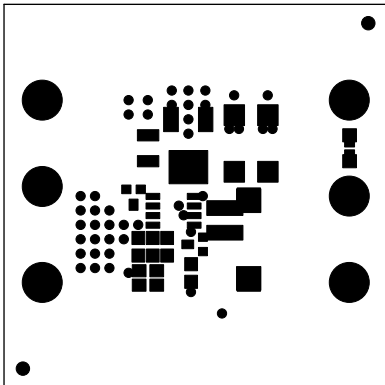

Component Side Solder Mask

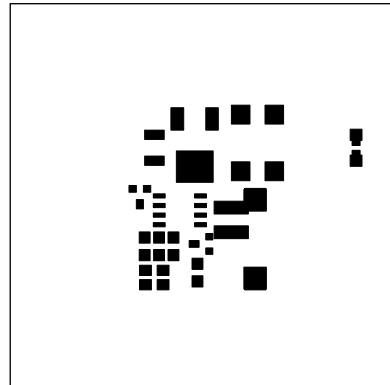

Component Side Paste Mask

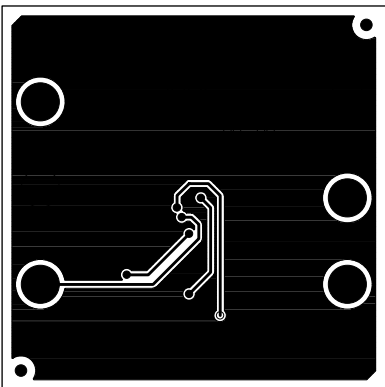

Solder Side

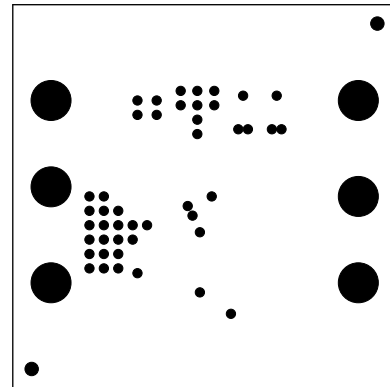

Solder Side Solder Mask

PCB LAYOUT AND FILM (DC238)

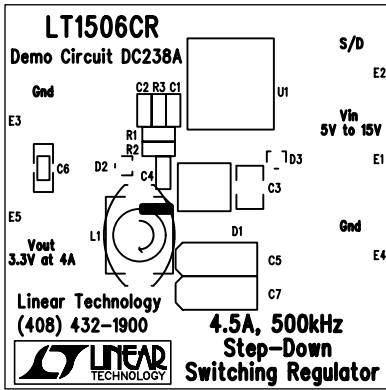

Component Side Silkscreen

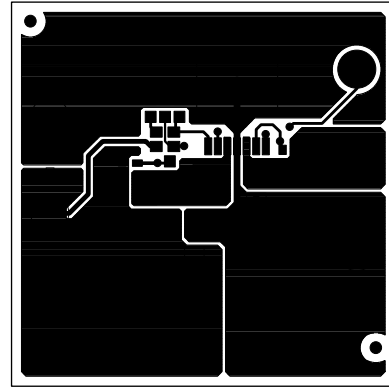

Component Side

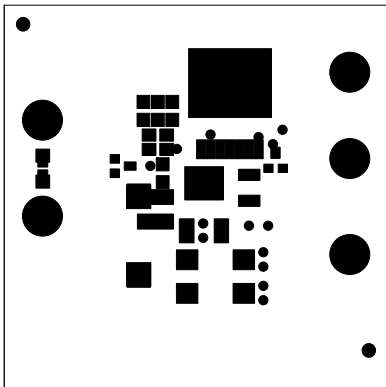

Component Side Solder Mask

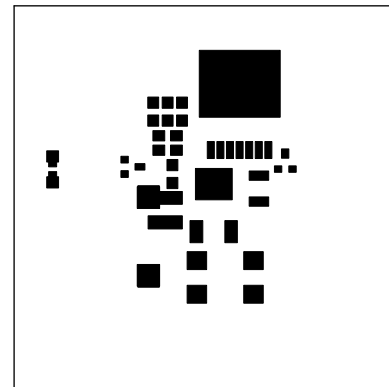

Component Side Paste Mask

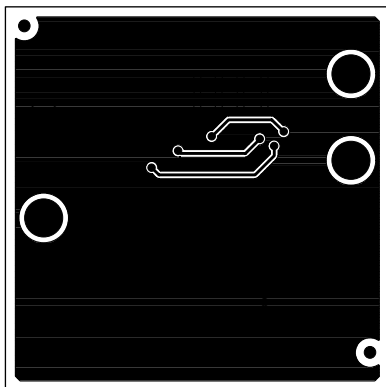

Solder Side

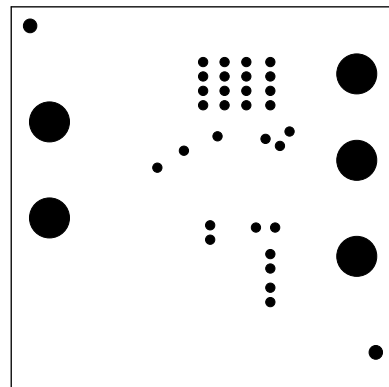

Solder Side Solder Mask

DEMO MANUAL DC237/DC238

NO-DESIGN SWITCHER

PC FAB DRAWINGS

DC237

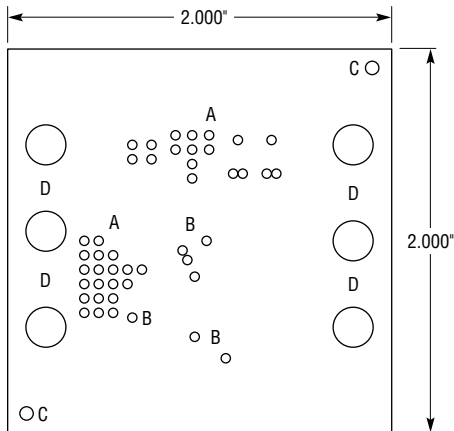

NOTES: UNLESS OTHERWISE SPECIFIED

1. MATERIAL: FR4 OR EQUIVALENT EPOXY, 2 OZ COPPER CLAD, THICKNESS 0.062 ±0.006 TOTAL OF 2 LAYERS
2. FINISH: ALL PLATED HOLES 0.001 MIN/0.0015 MAX COPPER PLATE, ELECTRODEPOSITED TIN-LEAD COMPOSITION BEFORE REFLOW, SOLDER MASK OVER BARE COPPER (SMOBC)
3. SOLDER MASK: BOTH SIDES USING SR1020 OR EQUIVALENT
4. SILKSCREEN: USING WHITE NONCONDUCTIVE EPOXY INK
5. ALL DIMENSIONS IN INCHES
6. SCORING

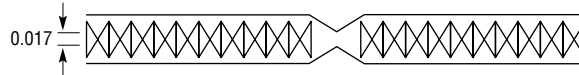

| SYMBOL | DIAMETER | NUMBER OF HOLES |
|-------------|----------|-----------------|
| A | 0.020 | 38 |
| B | 0.025 | 7 |
| C | 0.072 | 2 |
| D | 0.095 | 6 |
| TOTAL HOLES | | 53 |

DC237 FD

DC238

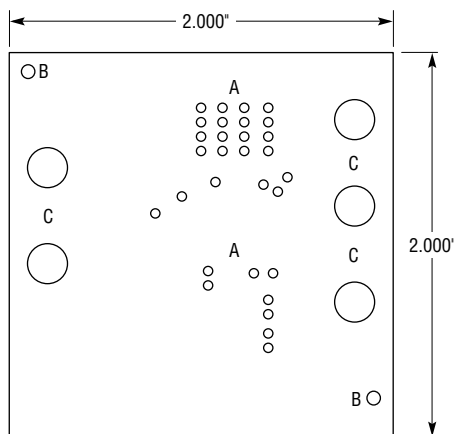

NOTES: UNLESS OTHERWISE SPECIFIED

1. MATERIAL: FR4 OR EQUIVALENT EPOXY, 2 OZ COPPER CLAD, THICKNESS 0.062 ±0.006 TOTAL OF 2 LAYERS
2. FINISH: ALL PLATED HOLES 0.001 MIN/0.0015 MAX COPPER PLATE, ELECTRODEPOSITED TIN-LEAD COMPOSITION BEFORE REFLOW, SOLDER MASK OVER BARE COPPER (SMOBC)
3. SOLDER MASK: BOTH SIDES USING GREEN SR1020 OR EQUIVALENT
4. SILKSCREEN: USING WHITE NONCONDUCTIVE EPOXY INK
5. ALL DIMENSIONS IN INCHES
6. SCORING

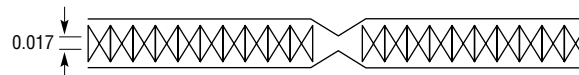

| SYMBOL | DIAMETER | NUMBER OF HOLES |
|-------------|----------|-----------------|
| A | 0.020 | 30 |
| B | 0.072 | 2 |
| C | 0.095 | 5 |
| TOTAL HOLES | | 37 |

DC238 FD