



# NTC thermistors for inrush current limiting

## Inrush Current Limiters (ICLs)

**Series/Type:** S236/\*\*/M\*\*  
**Ordering code:** B57236S0\*\*\*M0\*\*  
**Date:** 2021-04-22  
**Version:** a

© TDK Electronics AG 2021. Reproduction, publication and dissemination of this publication, enclosures hereto and the information contained therein without TDK Electronics' prior express consent is prohibited.

## Applications

- Inrush current limiting, e.g. in switch-mode power supplies, soft-start motors

## Features

- Leaded and coated NTC thermistors
- Tinned copper wire, kinked
- Coating material flame retardant to UL 94 V-0
- Component marking includes the manufacturer's logo, resistance value and data code
- Highly stable electrical characteristics

## Approvals

- UL 1434 (file number E338926)
- IEC
- VDE
- CQC

## Options

- Resistance tolerance <20% and alternative lead configurations available on request

## Delivery mode

- Bulk (standard), cardboard tape on reel or Ammo pack

## General technical data

Climatic category	(IEC 60068-1)		55/170/21	
Max. power	(at 25 °C)	$P_{max}$	2.1	W
Resistance tolerance		$\Delta R_R/R_R$	$\pm 20$	%
Rated temperature		$T_R$	25	°C
Dissipation factor	(in air)	$\delta_{th}$	approx. 10	mW/K
Thermal cooling time constant	(in air)	$\tau_{th}$	approx. 70	s
Heat capacity		$C_{th}$	approx. 700	mJ/K

Dimension drawings in mm

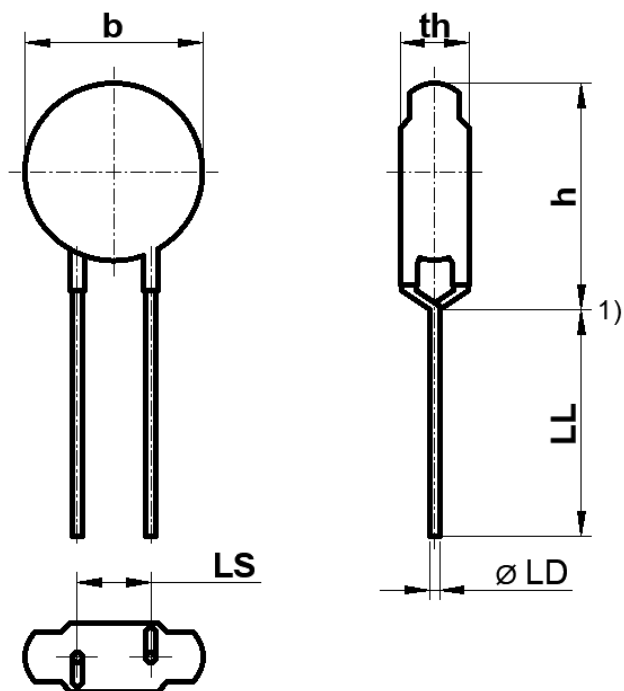

b	11.5 max.	mm
th	5.0 max.	mm
h	16.0 max.	mm
LL	25.0 min. <sup>2)</sup>	mm
LD	0.6 ±0.05	mm
LS	5.0 +0.6/-0.1	mm

1) Seating plane to IEC 60717

2) Effective Lead length acc. taping spec. IEC 60286-2

Approx. weight: 1 g

## Electrical specification and ordering codes

Table 1

R <sub>25</sub> Ω	I <sub>max1</sub> (0...65 °C) A	C <sub>t1</sub> at 230 V AC μF	C <sub>t2</sub> at 110 V AC μF	R <sub>min</sub> (at I <sub>max</sub> , 25 °C) Ω	Ordering code
2.2	6	200	800	0.057	<a href="#">B57236S0229M0**</a>
2.5	5.5	200	800	0.067	<a href="#">B57236S0259M0**</a>
3	5	300	1200	0.077	<a href="#">B57236S0309M0**</a>
4.7	4.6	300	1200	0.102	<a href="#">B57236S0479M0**</a>
5	4.5	300	1200	0.108	<a href="#">B57236S0509M0**</a>
8	3.7	300	1200	0.152	<a href="#">B57236S0809M0**</a>
10	3.5	300	1200	0.180	<a href="#">B57236S0100M0**</a>
12	3.2	300	1200	0.215	<a href="#">B57236S0120M0**</a>
16	2.9	300	1200	0.262	<a href="#">B57236S0160M0**</a>
20	2.8	300	1200	0.284	<a href="#">B57236S0200M0**</a>
25	2.5	300	1200	0.357	<a href="#">B57236S0250M0**</a>
40	2	300	1200	0.531	<a href="#">B57236S0400M0**</a>
50	1.9	300	1200	0.594	<a href="#">B57236S0500M0**</a>
80	1.6	400	1600	0.861	<a href="#">B57236S0800M0**</a>
120	1.5	400	1600	0.990	<a href="#">B57236S0121M0**</a>

Remark: I<sub>max1</sub> & C<sub>t1</sub> in table 1 are tested according to UL and IEC certificat.

### \*\*= Delivery mode

00=Bulk

51=Reel packing

54=Ammo packing

**Table 2**

R <sub>25</sub> Ω	I <sub>max2</sub> (0...65 °C) A	C <sub>t2</sub> at 230 V AC μF	C <sub>t2</sub> at 110 V AC μF	R <sub>min</sub> (at I <sub>max</sub> , 25 °C) Ω	Ordering code
2.2	5	520	2080	0.057	<a href="#">B57236S0229M0**</a>
2.5	5	520	2080	0.067	<a href="#">B57236S0259M0**</a>
4.7	4	350	1400	0.102	<a href="#">B57236S0479M0**</a>
10	3	300	1200	0.180	<a href="#">B57236S0100M0**</a>
25	2	350	1400	0.357	<a href="#">B57236S0250M0**</a>
40	2	263	1052	0.531	<a href="#">B57236S0400M0**</a>
50	2	300	1200	0.594	<a href="#">B57236S0500M0**</a>
120	1	400	1600	0.990	<a href="#">B57236S0121M0**</a>

 Remark: I<sub>max2</sub> & C<sub>t2</sub> in table 2 refer to below testing method.

**\*\*= Delivery mode**

00=Bulk

51=Reel packing

54=Ammo packing

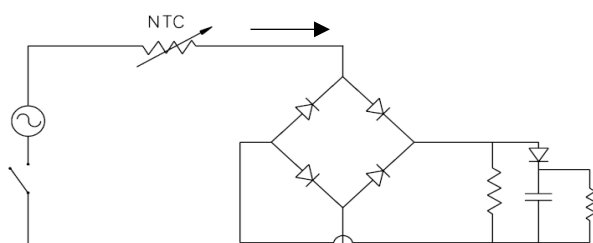
 C<sub>t2</sub> Test capacitance [μF]

 I<sub>max2</sub> Max current across the NTC under test [A]

Number of cycles: 1000

**Reliability data**

Test	Standard	Test conditions	$ \Delta R_{25}/R_{25} $ (typical)	Remarks
Storage in dry heat	IEC 60068-2-2	Storage at upper category temperature T: 170°C t: 1 000 h	< 20 %	No visible damage
Storage in damp heat, steady state	IEC 60068-2-78	Temperature of air: 40°C Relative humidity of air: 93 % Duration: 21 days	< 20 %	No visible damage
Rapid change of temperature	IEC 60068-2-14	Lower test temperature: -55 °C t: 30 min Upper test temperature: 170 °C t: 30 min Time to change from lower to upper temperature: < 30 s Number of cycles: 10	< 20 %	No visible damage
Endurance with max. current	IEC 60539-1	Ambient temperature: 25 ± 5 °C I = I <sub>max1</sub> or I <sub>max2</sub> t: 1000 h	< 20 %	No visible damage
Cyclic endurance	IEC 60539-1	Ambient temperature: 25 ± 5 °C I = I <sub>max1</sub> or I <sub>max2</sub> On-time = 1 min Cooling time = 5 min Number of cycles: 1000	< 20 %	No visible damage

### Resistance versus temperature (B57236S0\*\*\*M0\*\*)

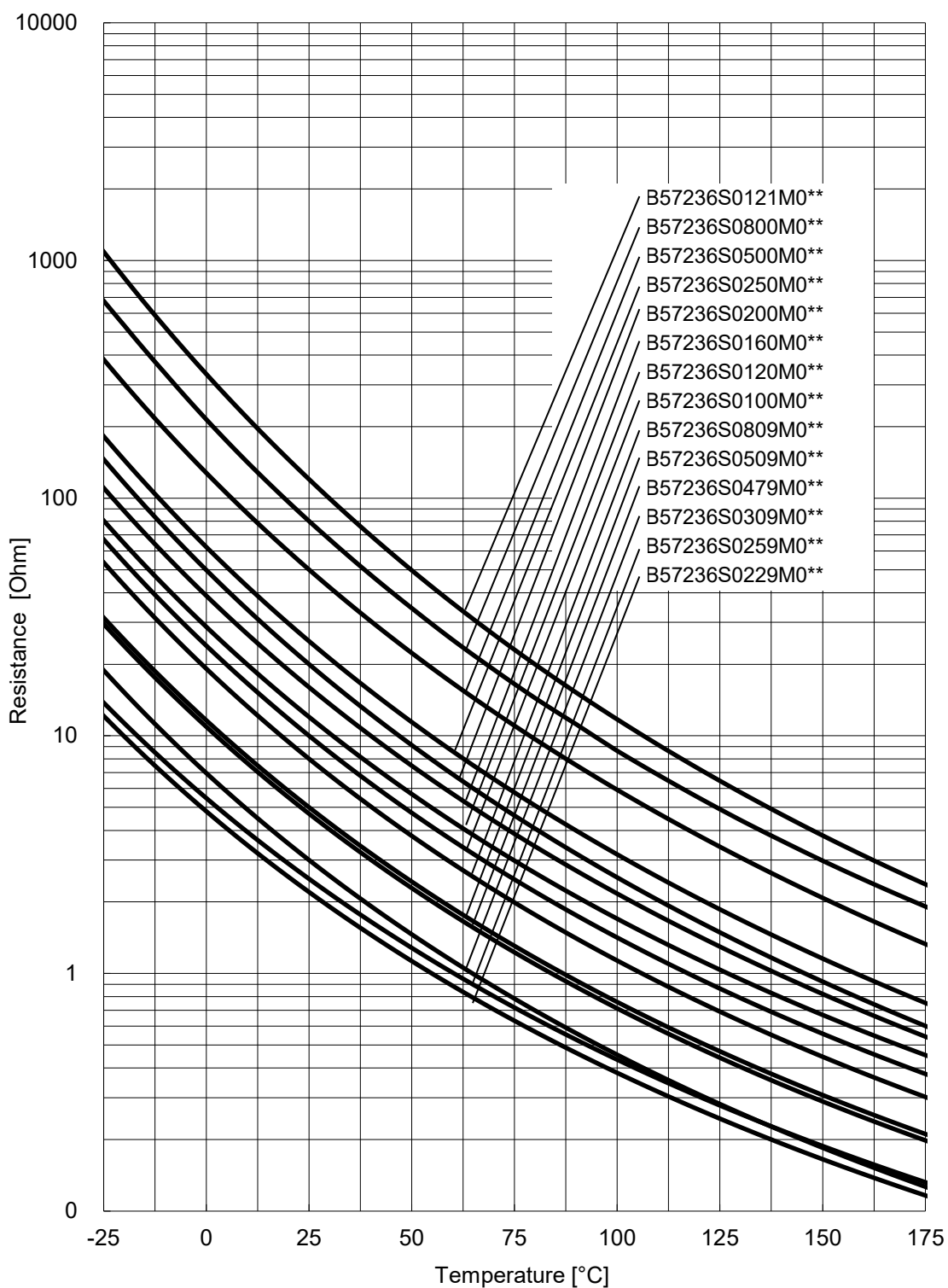

**Resistance versus temperature (B57236S0\*\*\*M0\*\*)**

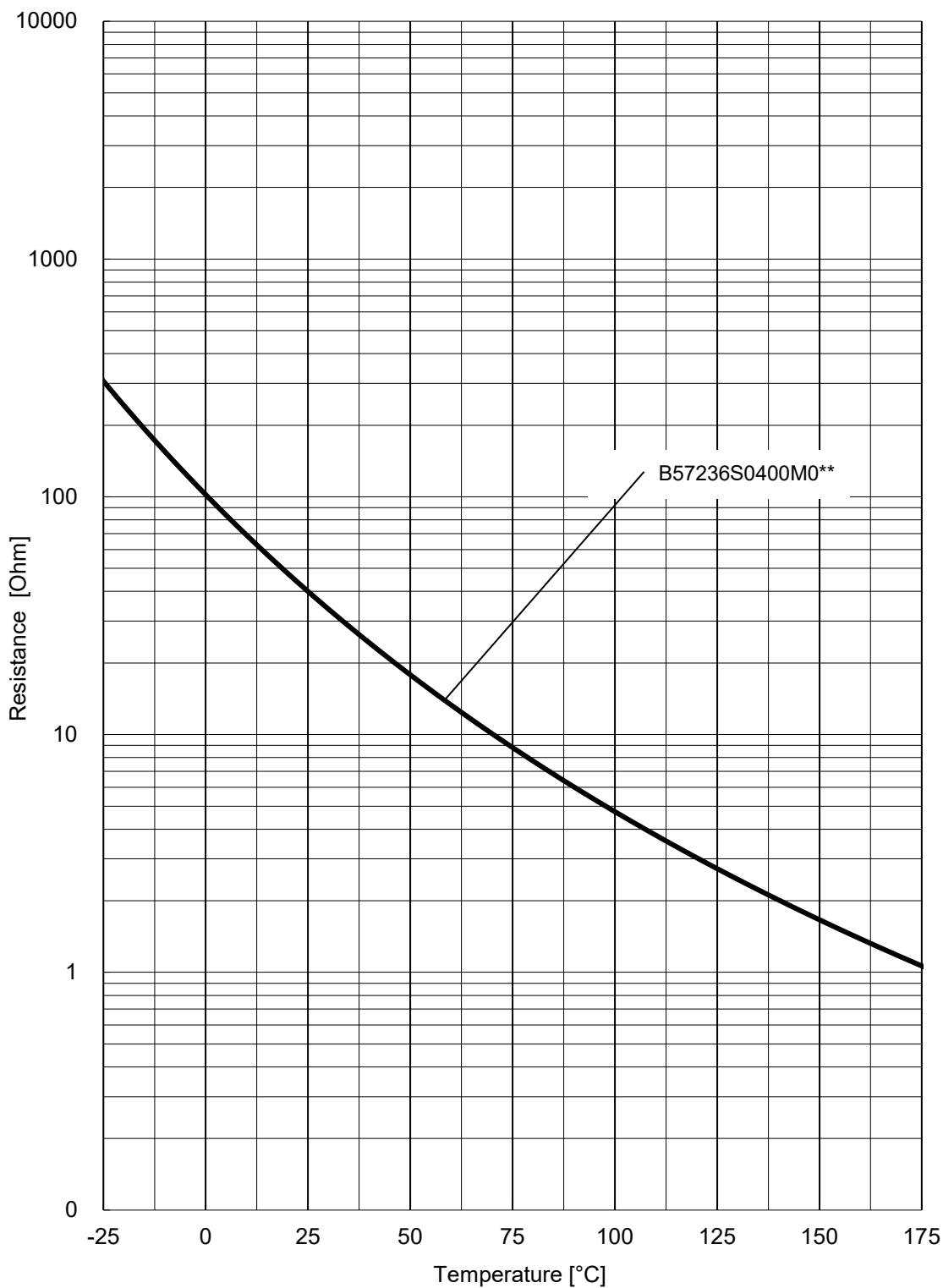



Resistance versus current (B57236S0\*\*\*M0\*\*)

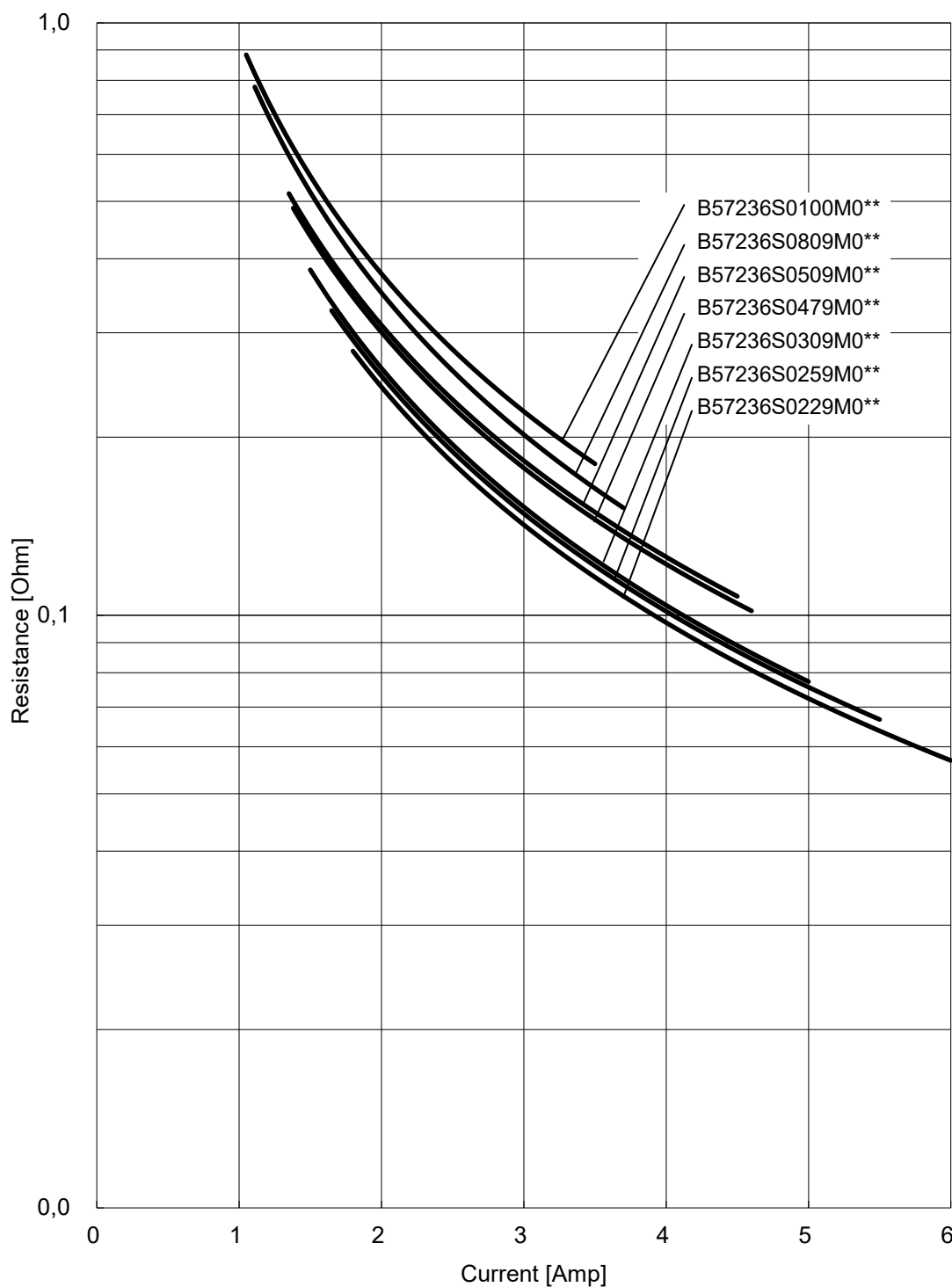

### Resistance versus current (B57236S0\*\*\*M0\*\*)

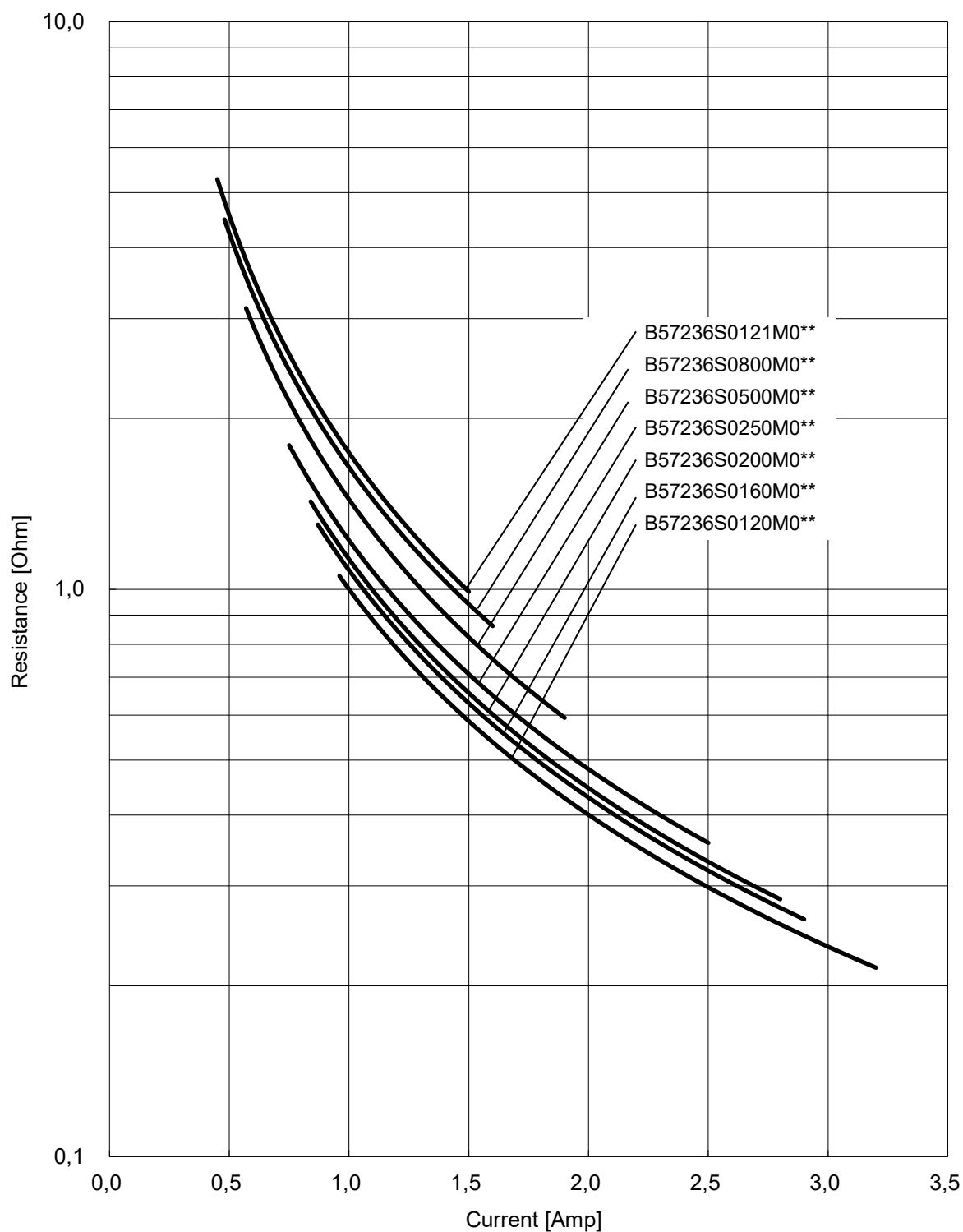

### Resistance versus current (B57236S0\*\*\*M0\*\*)

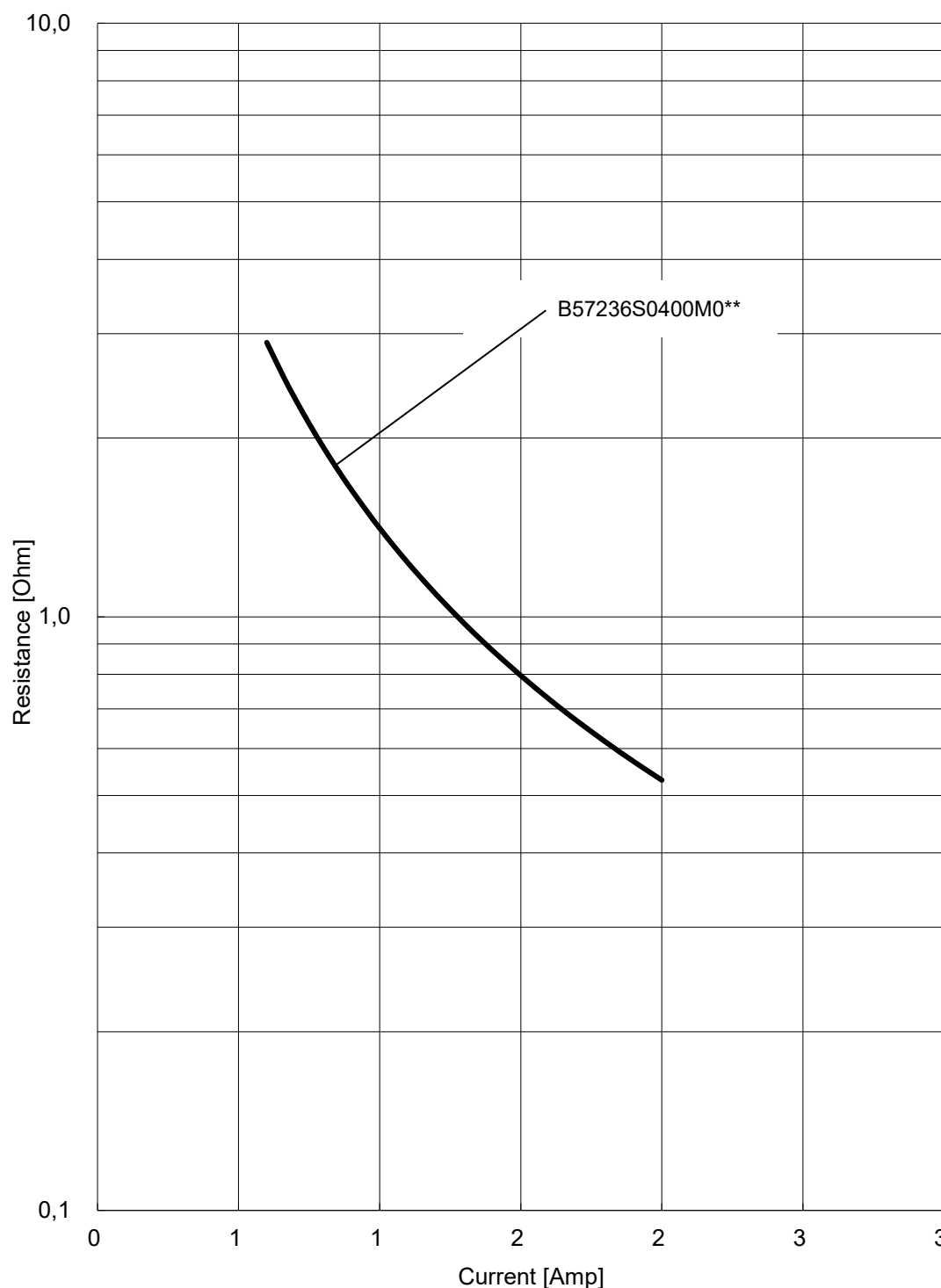

## Cautions and warnings

See "Important notes" of this data sheet.

## Storage

- Store thermistors only in original packaging. Do not open the package before storage.
- Storage conditions in original packaging: storage temperature -25 °C to +45 °C, relative humidity ≤75% annual mean, maximum 95%, dew precipitation is inadmissible.
- Avoid contamination of thermistors surface during storage, handling and processing.
- Avoid storage of thermistor in harmful environments like corrosive gases (SO<sub>x</sub>, Cl etc).
- Solder thermistors after shipment from TDK Electronics within the time specified:
  - Leaded components: 24 months

## Handling

- NTC inrush current limiters must not be dropped. Chip-offs must not be caused during handling of NTC inrush current limiters.
- Components must not be touched with bare hands. Gloves are recommended.
- Avoid contamination of thermistor surface during handling.
- In case of exposure of the NTC inrush current limiters to water, electrolytes or other aggressive media, these media can penetrate the coating and reach the surface of the ceramic. Low-ohmic or high-ohmic behavior may occur due to the formation of an electrolyte with metals (silver/lead/tin from metallization or solder). Low-ohmic behavior is caused by electrochemical migration, high-ohmic behavior by dissolving of the electrode. In either case, the functionality of the NTC inrush current limiters can not be assured.
- Washing processes may damage the product due to the possible static or cyclic mechanical loads (e.g. ultrasonic cleaning). They may cause cracks to develop on the product and its parts, which might lead to reduced reliability or lifetime.

## Bending / twisting leads

- A lead (wire) may be bent at a minimum distance of twice the wire's diameter plus 4 mm from the component head or housing. When bending ensure the wire is mechanically relieved at the component head or housing. The bending radius should be at least 0.75 mm.
- Twisting (torsion) by 180° of a lead bent by 90° is permissible at 6 mm from the bottom of the thermistor body.

## Soldering

- Use resin-type flux or non-activated flux.
- Insufficient preheating may cause ceramic cracks.
- Rapid cooling by dipping in solvent is not recommended.
- Complete removal of flux is recommended.

## Mounting

- When thermistors are sealed, potted or over-molded, there must be no mechanical stress caused by thermal expansion during the production process (curing/ over-molding process) and during later operation. The upper category temperature of the thermistor must not be exceeded. Ensure that the materials used (sealing / potting compound and plastic material) are chemically neutral.
- Electrode must not be scratched before/during/after the mounting process.
- Contacts and housings used for assembly with thermistor have to be clean before mounting.
- During operation, the inrush current limiters surface temperature can be very high. Ensure that adjacent components are placed at a sufficient distance from the thermistor to allow for proper cooling of the NTC inrush current limiters.
- Ensure that adjacent materials are designed for operation at temperatures comparable to the surface temperature of the thermistor. Be sure that surrounding parts and materials can withstand this temperature.
- Make sure that inrush current limiters are adequately ventilated to avoid overheating.
- Avoid contamination of thermistor surface during processing.

## Operation

- Use NTC inrush current limiters only within the specified operating temperature range.
- Use NTC inrush current limiters only within the specified voltage and current ranges.
- Environmental conditions must not harm the NTC inrush current limiters. Use NTC inrush current limiters only in normal atmospheric conditions.
- Contact of NTC inrush current limiters with any liquids and solvents should be prevented. It must be ensured that no water enters the NTC inrush current limiters (e.g. through plug terminals). For measurement purposes (checking the specified resistance vs. temperature), the component must not be immersed in water but in suitable liquids (e.g. Galden).
- In case of exposure of the NTC inrush current limiters to water, electrolytes or other aggressive media, these media can penetrate the coating and reach the surface of the ceramic. Low-ohmic or high-ohmic behavior may occur due to the formation of an electrolyte with metals (silver/lead/tin from metallization or solder). Low-ohmic behavior is caused by electrochemical migration, high-ohmic behavior by dissolving of the electrode. In either case, the functionality of the NTC inrush current limiters can not be assured.
- Be sure to provide an appropriate fail-safe function to prevent secondary product damage caused by malfunction (e.g. use a metal oxide varistor for limitation of overvoltage condition).

## Display of ordering codes for TDK Electronics products

The ordering code for one and the same product can be represented differently in data sheets, data books, other publications, on the company website, or in order-related documents such as shipping notes, order confirmations and product labels. **The varying representations of the ordering codes are due to different processes employed and do not affect the specifications of the respective products.** Detailed information can be found on the Internet under [www.tdk-electronics.tdk.com/orderingcodes](http://www.tdk-electronics.tdk.com/orderingcodes).

## Other related documents

Further information completing this data sheet is listed on the TDK website at <https://product.tdk.com/en/products/protection/current/ntc-limiter/index.html>

## [General Technical Information](#)

## [Quality and Environment](#)

## [Symbols and Terms](#)

## [Mounting Instructions](#)

## [Taping and Packing](#)

## [Climatic Conditions](#)

## [RoHS and SVHC/REACH Declaration](#)

## [Selection Guide](#)

## [Application Note](#)

## Important notes

The following applies to all products named in this publication:

1. Some parts of this publication contain **statements about the suitability of our products for certain areas of application**. These statements are based on our knowledge of typical requirements that are often placed on our products in the areas of application concerned. We nevertheless expressly point out **that such statements cannot be regarded as binding statements about the suitability of our products for a particular customer application**. As a rule we are either unfamiliar with individual customer applications or less familiar with them than the customers themselves. For these reasons, it is always ultimately incumbent on the customer to check and decide whether a product with the properties described in the product specification is suitable for use in a particular customer application.
2. We also point out that **in individual cases, a malfunction of electronic components or failure before the end of their usual service life cannot be completely ruled out in the current state of the art, even if they are operated as specified**. In customer applications requiring a very high level of operational safety and especially in customer applications in which the malfunction or failure of an electronic component could endanger human life or health (e.g. in accident prevention or life-saving systems), it must therefore be ensured by means of suitable design of the customer application or other action taken by the customer (e.g. installation of protective circuitry or redundancy) that no injury or damage is sustained by third parties in the event of malfunction or failure of an electronic component.
3. **The warnings, cautions and product-specific notes must be observed.**
4. In order to satisfy certain technical requirements, **some of the products described in this publication may contain substances subject to restrictions in certain jurisdictions (e.g. because they are classed as hazardous)**. Useful information on this will be found in our Material Data Sheets on the Internet ([www.tdk-electronics.tdk.com/material](http://www.tdk-electronics.tdk.com/material)). Should you have any more detailed questions, please contact our sales offices.
5. We constantly strive to improve our products. Consequently, **the products described in this publication may change from time to time**. The same is true of the corresponding product specifications. Please check therefore to what extent product descriptions and specifications contained in this publication are still applicable before or when you place an order.

We also **reserve the right to discontinue production and delivery of products**. Consequently, we cannot guarantee that all products named in this publication will always be available. The aforementioned does not apply in the case of individual agreements deviating from the foregoing for customer-specific products.

6. Unless otherwise agreed in individual contracts, **all orders are subject to our General Terms and Conditions of Supply**.
7. **Our manufacturing sites serving the automotive business apply the IATF 16949 standard**. The IATF certifications confirm our compliance with requirements regarding the quality management system in the automotive industry. Referring to customer requirements and customer specific requirements ("CSR") TDK always has and will continue to have the policy of respecting individual agreements. Even if IATF 16949 may appear to support the acceptance of unilateral requirements, we hereby like to emphasize that **only requirements mutually agreed upon can and will be implemented in our Quality Management System**. For clarification purposes we like to point out that obligations from IATF 16949 shall only become legally binding if individually agreed upon.

## Important notes

8. The trade names EPCOS, CarXield, CeraCharge, CeraDiode, CeraLink, CeraPad, CeraPlas, CSMP, CTVS, DeltaCap, DigiSiMic, ExoCore, FilterCap, FormFit, LeaXield, MiniBlue, MiniCell, MKD, MKK, ModCap, MotorCap, PCC, PhaseCap, PhaseCube, PhaseMod, PhiCap, PowerHap, PQSine, PQvar, SIFERRIT, SIFI, SIKOREL, SilverCap, SIMDAD, SiMic, SIMID, SineFormer, SIOV, ThermoFuse, WindCap, XieldCap are **trademarks registered or pending** in Europe and in other countries. Further information will be found on the Internet at [www.tdk-electronics.tdk.com/trademarks](http://www.tdk-electronics.tdk.com/trademarks).

Release 2020-06