



FEATURES

- 1.8 V to 5.5 V single-supply operation
- ±2.5 V dual-supply operation
- On resistance: 4 Ω at 25°C (+5 V single supply/±2.5 V dual supply)
- 0.5 Ω on-resistance flatness at 25°C (+5 V single supply/±2.5 V dual supply)
- Rail-to-rail operation
- Transition times: 23 ns typical at 25°C
- Single 32-to-1 channel multiplexer
- Dual/differential 16-to-1 channel multiplexer
- TTL-/CMOS-compatible inputs
- 48-lead TQFP or 48-lead, 7 mm × 7 mm LFCSP

APPLICATIONS

- Optical applications
- Data acquisition systems
- Communication systems
- Relay replacement
- Audio and video switching
- Battery-powered systems
- Medical instrumentation
- Automatic test equipment (ATE)

GENERAL DESCRIPTION

The [ADG726/ADG732](#) are monolithic, complementary metal oxide semiconductor (CMOS) 32-channel and dual 16-channel analog multiplexers. The [ADG732](#) switches one of 32 inputs (S1 to S32) to a common output, D, as determined by the 5-bit binary address lines A0, A1, A2, A3, and A4. The [ADG726](#) switches one of 16 inputs as determined by the 4-bit binary address lines A0, A1, A2, and A3.

On-chip latches facilitate microprocessor interfacing. The [ADG726](#) may also be configured for differential operation by tying \overline{CSA} and \overline{CSB} together. An \overline{EN} input is used to enable or disable the devices. When disabled, all channels are switched off.

These multiplexers are designed on an enhanced submicron process that provides low power dissipation yet gives high switching speed, very low on resistance, and leakage currents. They operate from a single supply of +1.8 V to +5.5 V and a ±2.5 V dual supply, making them ideally suited to a variety of applications. On resistance is in the region of a few ohms and is

Rev. C

[Document Feedback](#)

Information furnished by Analog Devices is believed to be accurate and reliable. However, no responsibility is assumed by Analog Devices for its use, nor for any infringements of patents or other rights of third parties that may result from its use. Specifications subject to change without notice. No license is granted by implication or otherwise under any patent or patent rights of Analog Devices. Trademarks and registered trademarks are the property of their respective owners.

FUNCTIONAL BLOCK DIAGRAMS

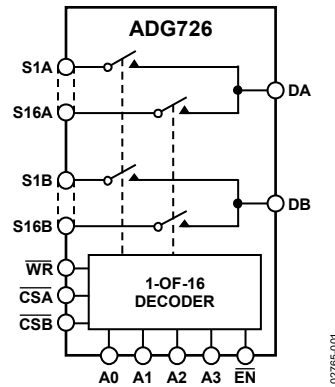

Figure 1.

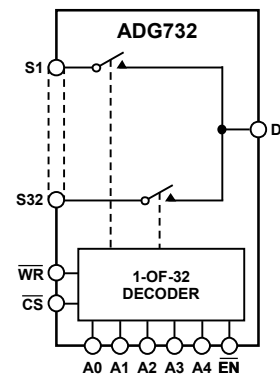

Figure 2.

closely matched between switches and very flat over the full signal range. These devices can operate equally well as either multiplexers or demultiplexers and have an input signal range that extends to the supplies. In the off condition, signal levels up to the supplies are blocked. All channels exhibit break-before-make switching action, preventing momentary shorting when switching channels.

The [ADG726/ADG732](#) are available in a 48-lead LFCSP or a 48-lead TQFP. For functionally equivalent devices with serial interface, see the [ADG725/ADG731](#).

PRODUCT HIGHLIGHTS

- +1.8 V to +5.5 V single- or ±2.5 V dual-supply operation. These devices are specified and guaranteed with +5 V ± 10%, +3 V ± 10% single-supply, and ±2.5 V ± 10% dual-supply rails.
- An on resistance of 4 Ω.
- Guaranteed break-before-make switching action.
- 48-lead LFCSP package or 48-lead TQFP package.

TABLE OF CONTENTS

Features	1	Absolute Maximum Ratings	9
Applications	1	ESD Caution	9
Functional Block Diagrams.....	1	Pin Configurations and Function Description	10
General Description	1	48-Lead TQFP	10
Product Highlights.....	1	48-Lead LFCSP	12
Revision History	2	Typical Performance Characteristics	15
Specifications	3	Test Circuits	17
+5 V Single Supply	3	Terminology.....	20
+3 V Single Supply	5	Outline Dimensions.....	21
±2.5 V Dual Supply	7	Ordering Guide	21
Timing Characteristics	8		

REVISION HISTORY

2/2021—Rev. B to Rev. C

Changed CP-48-1 to CP-48-4.....	Throughout
Changes to Figure 6.....	12
Changes to Figure 7.....	13
Updated Outline Dimensions.....	21
Changes to Ordering Guide.....	21

6/2015—Rev. A to Rev. B

Changes to Figure 4 and Table 6.....	10
Added Figure 5 and Table 7; Renumbered Sequentially	11
Added Figure 6 and Table 8.....	12
Changes to Figure 7, Table 9, and Table 10	13
Changes to Table 11	14

2/2015—Rev. 0 to Rev. A

Updated Format	Universal
Changes to Features Section	1
Changes to Table 1	3

Changes to Table 2	5
Changes to Table 3	7
Changes to Table 5	9
Added Table 6; Renumbered Sequentially	10
Added Table 7	11
Changes to Figure 5	11
Changes to Figure 8 to Figure 11	13
Changes to Figure 13 and Figure 15 to Figure 17.....	14
Changes to Figure 25 to Figure 28	16
Changes to Figure 29	17
Moved Terminology Section	18
Changes to Terminology Section	18
Updated Outline Dimensions	19
Changes to Ordering Guide.....	19

7/2002—Revision 0: Initial Version

SPECIFICATIONS

+5 V SINGLE SUPPLY

$V_{DD} = 5\text{ V} \pm 10\%$, $V_{SS} = 0\text{ V}$, $GND = 0\text{ V}$, unless otherwise noted.

Table 1.

Parameter	Symbol	ADG726/ADG732		ADG732	Unit	Test Conditions/Comments
		+25°C	-40°C to +85°C	-40°C to +125°C		
ANALOG SWITCH						
Analog Signal Range			0 V to V_{DD}		V	
On Resistance	R_{ON}	4	5		Ω typ	$V_S = 0\text{ V to }V_{DD}$, $I_{DS} = 10\text{ mA}$, see Figure 20
		5.5	6	7	Ω max	
On Resistance Match Between Channels	ΔR_{ON}		0.3		Ω typ	$V_S = 0\text{ V to }V_{DD}$, $I_{DS} = 10\text{ mA}$
			0.8	1	Ω max	
On Resistance Flatness	$R_{FLAT(ON)}$	0.5			Ω typ	$V_S = 0\text{ V to }V_{DD}$, $I_{DS} = 10\text{ mA}$
			1	1.2	Ω max	
LEAKAGE CURRENTS						
Source Off Leakage	I_S (Off)	± 0.01			nA typ	$V_{DD} = 5.5\text{ V}$ $V_D = 4.5\text{ V}/1\text{ V}$, $V_S = 1\text{ V}/4.5\text{ V}$, see Figure 21
		± 0.25	± 1	± 2	nA max	
Drain Off Leakage	I_D (Off)	± 0.05			nA typ	$V_D = 4.5\text{ V}/1\text{ V}$, $V_S = 1\text{ V}/4.5\text{ V}$, see Figure 24
		± 0.5	± 2.5		nA max	
		± 1	± 5	± 10	nA max	
Channel On Leakage	I_D, I_S (On)	± 0.05			nA typ	$V_D = V_S = 1\text{ V}$, or 4.5 V, see Figure 25
		± 0.5	± 2.5		nA max	
		± 1	± 5	± 10	nA max	
DIGITAL INPUTS						
Input High Voltage	V_{INH}		2.4	2.4	V min	
Input Low Voltage	V_{INL}		0.8	0.8	V max	
Input Current						
Low or High	I_{INL} or I_{INH}	0.005			μA typ	$V_{IN} = V_{INL}$ or V_{INH}
			± 0.5	± 0.5	μA max	
Digital Input Capacitance	C_{IN}	5			pF typ	
DYNAMIC CHARACTERISTICS¹						
Transition Time	$t_{TRANSITION}$	23			ns typ	$R_L = 300\ \Omega$, $C_L = 35\text{ pF}$, see Figure 27
		34	40	48	ns max	$V_{S1} = 3\text{ V}/0\text{ V}$, $V_{S32} = 0\text{ V}/3\text{ V}$
Break-Before-Make Time Delay	t_D	18			ns typ	$R_L = 300\ \Omega$, $C_L = 35\text{ pF}$; $V_S = 3\text{ V}$, see Figure 28
			1	1	ns min	
On Time (\overline{CS} , \overline{WR})	$t_{ON}(\overline{CS}, \overline{WR})$	18			ns typ	$R_L = 300\ \Omega$, $C_L = 35\text{ pF}$; $V_S = 3\text{ V}$, see Figure 29
		25	32	38.5	ns max	
Off Time (\overline{CS} , \overline{WR})	$t_{OFF}(\overline{CS}, \overline{WR})$	17			ns typ	$R_L = 300\ \Omega$, $C_L = 35\text{ pF}$; $V_S = 3\text{ V}$, see Figure 29
		23	29	33	ns max	
On Time (\overline{EN})	$t_{ON}(\overline{EN})$	24			ns typ	$R_L = 300\ \Omega$, $C_L = 35\text{ pF}$; $V_S = 3\text{ V}$, see Figure 30
		32	40	43	ns max	
Off Time (\overline{EN})	$t_{OFF}(\overline{EN})$	16			ns typ	$R_L = 300\ \Omega$, $C_L = 35\text{ pF}$; $V_S = 3\text{ V}$, see Figure 30
		22	25	25	ns max	
Charge Injection	Q_{INJ}	5			pC typ	$V_S = 2.5\text{ V}$, $R_S = 0\ \Omega$, $C_L = 1\text{ nF}$, see Figure 31
Off Isolation	I_{SO}	-72			dB typ	$R_L = 50\ \Omega$, $C_L = 5\text{ pF}$, $f = 1\text{ MHz}$, see Figure 22
Channel-to-Channel Crosstalk	C_{TK}	-72			dB typ	$R_L = 50\ \Omega$, $C_L = 5\text{ pF}$, $f = 1\text{ MHz}$, see Figure 23
-3 dB Bandwidth	BW					$R_L = 50\ \Omega$, $C_L = 5\text{ pF}$, see Figure 26
		34			MHz typ	
		18			MHz typ	

Parameter	Symbol	ADG726/ADG732		ADG732	Unit	Test Conditions/Comments
		+25°C	-40°C to +85°C	-40°C to +125°C		
Off Switch Source Capacitance	C _S (Off)	13			pF typ	f = 1 MHz
Off Switch Drain Capacitance	C _D (Off)	170			pF typ	f = 1 MHz
ADG726		340			pF typ	f = 1 MHz
ADG732						
On Switch Drain, Source Capacitance	C _D , C _S (On)	175			pF typ	f = 1 MHz
ADG726		350			pF typ	f = 1 MHz
ADG732						
POWER REQUIREMENTS						
Positive Supply Current	I _{DD}	10	20	20	μA typ μA max	V _{DD} = 5.5 V Digital inputs = 0 V or 5.5 V

¹ Guaranteed by design; not subject to production test.

+3 V SINGLE SUPPLY

$V_{DD} = 3 \text{ V} \pm 10\%$, $V_{SS} = 0 \text{ V}$, $GND = 0 \text{ V}$, unless otherwise noted.

Table 2.

Parameter	Symbol	ADG726/ADG732		ADG732	Unit	Test Conditions/Comments
		+25°C	−40°C to +85°C	−40°C to +125°C		
ANALOG SWITCH						
Analog Signal Range			0 V to V_{DD}		V	
On Resistance	R_{ON}	7	12	13	Ω typ Ω max	$V_S = 0 \text{ V to } V_{DD}$, $I_{DS} = 10 \text{ mA}$, see Figure 20
On Resistance Match Between Channels	ΔR_{ON}	11	0.35		Ω typ	$V_S = 0 \text{ V to } V_{DD}$, $I_{DS} = 10 \text{ mA}$
On Resistance Flatness	$R_{FLAT(ON)}$		1 3	1	Ω max Ω typ	$V_S = 0 \text{ V to } V_{DD}$, $I_{DS} = 10 \text{ mA}$
LEAKAGE CURRENTS						
Source Off Leakage	I_S (Off)	± 0.01 ± 0.25	± 1	± 2	nA typ nA max	$V_{DD} = 3.3 \text{ V}$ $V_S = 3 \text{ V}/1 \text{ V}$, $V_D = 1 \text{ V}/3 \text{ V}$, see Figure 21
Drain Off Leakage	I_D (Off)	± 0.05 ± 0.5	± 2.5		nA typ nA max	$V_S = 1 \text{ V}/3 \text{ V}$, $V_D = 3 \text{ V}/1 \text{ V}$, see Figure 24
Channel On Leakage	I_D, I_S (On)	± 0.05 ± 0.5 ± 1	± 5 ± 2.5 ± 5	± 10 ± 10 ± 10	nA max nA max nA max	$V_S = V_D = 1 \text{ V or } 3 \text{ V}$, see Figure 25
DIGITAL INPUTS						
Input High Voltage	V_{INH}		2.0	2.0	V min	
Input Low Voltage	V_{INL}		0.7	0.7	V max	
Input Current	I_{INL} or I_{INH}	0.005	± 0.5	± 0.5	μA typ μA max	$V_{IN} = V_{INL}$ or V_{INH}
Digital Input Capacitance	C_{IN}	5			pF typ	
DYNAMIC CHARACTERISTICS¹						
Transition Time	$t_{TRANSITION}$	34 52	62	69	ns typ ns max	$R_L = 300 \Omega$, $C_L = 35 \text{ pF}$, see Figure 27 $V_{S1} = 2 \text{ V}/0 \text{ V}$, $V_{S32} = 0 \text{ V}/2 \text{ V}$
Break-Before-Make Time Delay	t_D	26	1	1	ns typ ns min	$R_L = 300 \Omega$, $C_L = 35 \text{ pF}$; $V_S = 2 \text{ V}$, see Figure 28
On Time (\overline{CS} , \overline{WR})	$t_{ON}(\overline{WR}, \overline{CS})$	29			ns typ	$R_L = 300 \Omega$, $C_L = 35 \text{ pF}$; $V_S = 2 \text{ V}$, see Figure 29
Off Time (\overline{CS} , \overline{WR})	$t_{OFF}(\overline{WR}, \overline{CS})$	43 26	52	60	ns max ns typ	$R_L = 300 \Omega$, $C_L = 35 \text{ pF}$; $V_S = 2 \text{ V}$, see Figure 29
On Time (\overline{EN})	$t_{ON}(\overline{EN})$	38 33	42	55.5	ns max ns typ	$R_L = 300 \Omega$, $C_L = 35 \text{ pF}$; $V_S = 2 \text{ V}$, see Figure 30
Off Time (\overline{EN})	$t_{OFF}(\overline{EN})$	48 19	55	63.5	ns max ns typ	$R_L = 300 \Omega$, $C_L = 35 \text{ pF}$; $V_S = 2 \text{ V}$, see Figure 30
Charge Injection	Q_{INJ}	25	28	28	ns max pC typ	$V_S = 1.5 \text{ V}$, $R_S = 0 \Omega$, $C_L = 1 \text{ nF}$, see Figure 31
Off Isolation	I_{SO}	1			dB typ	$R_L = 50 \Omega$, $C_L = 5 \text{ pF}$, $f = 1 \text{ MHz}$, see Figure 22
Channel-to-Channel Crosstalk	C_{TK}	−72			dB typ	$R_L = 50 \Omega$, $C_L = 5 \text{ pF}$, $f = 1 \text{ MHz}$, see Figure 23
−3 dB Bandwidth	BW	−72			dB typ	$R_L = 50 \Omega$, $C_L = 5 \text{ pF}$, see Figure 26
		34			MHz typ	
		18			MHz typ	

Parameter	Symbol	ADG726/ADG732		ADG732	Unit	Test Conditions/Comments
		+25°C	-40°C to +85°C	-40°C to +125°C		
Off Switch Source Capacitance	C _S (Off)	13			pF typ	f = 1 MHz
Off Switch Drain Capacitance	C _D (Off)	170			pF typ	f = 1 MHz
		340			pF typ	f = 1 MHz
On Switch Drain, Source Capacitance	C _D , C _S (On)					
		175			pF typ	f = 1 MHz
		350			pF typ	f = 1 MHz
POWER REQUIREMENTS						
Positive Supply Current	I _{DD}	5	10	10	μA typ μA max	V _{DD} = 3.3 V Digital inputs = 0 V or 3.3 V

¹ Guaranteed by design; not subject to production test.

±2.5 V DUAL SUPPLY

$V_{DD} = +2.5\text{ V} \pm 10\%$, $V_{SS} = -2.5\text{ V} \pm 10\%$, $GND = 0\text{ V}$, unless otherwise noted.

Table 3.

Parameter	Symbol	ADG726/ADG732		ADG732	Unit	Test Conditions/Comments
		+25°C	-40°C to +85°C	-40°C to +125°C		
ANALOG SWITCH						
Analog Signal Range			V_{SS} to V_{DD}		V	
On Resistance	R_{ON}	4			Ω typ	$V_S = V_{SS}$ to V_{DD} , $I_{DS} = 10\text{ mA}$, see Figure 20
		5.5	6	7	Ω max	
On Resistance Match Between Channels	ΔR_{ON}		0.3		Ω typ	$V_S = V_{SS}$ to V_{DD} , $I_{DS} = 10\text{ mA}$
On Resistance Flatness	$R_{FLAT(ON)}$	0.5	0.8	1	Ω max	
			1	1.2	Ω typ	$V_S = V_{SS}$ to V_{DD} , $I_{DS} = 10\text{ mA}$
					Ω max	
LEAKAGE CURRENTS						
Source Off Leakage	I_S (Off)	± 0.01			nA typ	$V_{DD} = +2.75\text{ V}$, $V_{SS} = -2.75\text{ V}$ $V_S = +2.25\text{ V}/-1.25\text{ V}$, $V_D = -1.25\text{ V}/+2.25\text{ V}$, see Figure 21
Drain Off Leakage	I_D (Off)	± 0.25 ± 0.05	± 0.5	± 1	nA max nA typ	$V_S = +2.25\text{ V}/-1.25\text{ V}$, $V_D = -1.25\text{ V}/+2.25\text{ V}$, see Figure 24
Channel On Leakage	I_D, I_S (On)	± 0.5 ± 1 ± 0.05 ± 0.5 ± 1	± 2.5 ± 5 ± 2.5 ± 5	± 10 ± 10	nA max nA max nA typ nA max nA max	$V_S = V_D = +2.25\text{ V}/-1.25\text{ V}$, see Figure 25
DIGITAL INPUTS						
Input High Voltage	V_{INH}		1.7	1.7	V min	
Input Low Voltage	V_{INL}		0.7	0.7	V max	
Input Current	I_{INL} or I_{INH}	0.005			μA typ	$V_{IN} = V_{INL}$ or V_{INH}
			± 0.5	± 0.5	μA max	
Digital Input Capacitance	C_{IN}	5			pF typ	
DYNAMIC CHARACTERISTICS¹						
Transition Time	$t_{TRANSITION}$	33			ns typ	$R_L = 300\ \Omega$, $C_L = 35\text{ pF}$, see Figure 27
		45	51	56	ns max	$V_{S1} = 1.5\text{ V}/0\text{ V}$, $V_{S32} = 0\text{ V}/1.5\text{ V}$
Break-Before-Make Time Delay	t_D	15	1	1	ns typ	$R_L = 300\ \Omega$, $C_L = 35\text{ pF}$; $V_S = 1.5\text{ V}$, see Figure 28
On Time (\overline{CS} , \overline{WR})	$t_{ON}(\overline{WR}, \overline{CS})$	21			ns min	
		30	37	43	ns typ	$R_L = 300\ \Omega$, $C_L = 35\text{ pF}$; $V_S = 1.5\text{ V}$, see Figure 29
Off Time (\overline{CS} , \overline{WR})	$t_{OFF}(\overline{WR}, \overline{CS})$	20			ns max	
		29	35	38	ns typ	$R_L = 300\ \Omega$, $C_L = 35\text{ pF}$; $V_S = 1.5\text{ V}$, see Figure 29
On Time (\overline{EN})	$t_{ON}(\overline{EN})$	26			ns max	
		37		50	ns typ	$R_L = 300\ \Omega$, $C_L = 35\text{ pF}$; $V_S = 1.8\text{ V}$, see Figure 30
Off Time (\overline{EN})	$t_{OFF}(\overline{EN})$	18			ns max	
		26	29	29	ns typ	$R_L = 300\ \Omega$, $C_L = 35\text{ pF}$; $V_S = 1.8\text{ V}$, see Figure 30
Charge Injection	Q_{INJ}	1			pC typ	$V_S = 0\text{ V}$, $R_S = 0\ \Omega$, $C_L = 1\text{ nF}$, see Figure 31
Off Isolation	I_{SO}	-72			dB typ	$R_L = 50\ \Omega$, $C_L = 5\text{ pF}$, $f = 1\text{ MHz}$, see Figure 22
Channel-to-Channel Crosstalk	C_{TK}	-72			dB typ	$R_L = 50\ \Omega$, $C_L = 5\text{ pF}$, $f = 1\text{ MHz}$, see Figure 23
-3 dB Bandwidth	BW					$R_L = 50\ \Omega$, $C_L = 5\text{ pF}$, see Figure 26
		34			MHz typ	
		18			MHz typ	

Parameter	Symbol	ADG726/ADG732		ADG732	Unit	Test Conditions/Comments
		+25°C	-40°C to +85°C	-40°C to +125°C		
Off Switch Source Capacitance	C _S (Off)	13			pF typ	
Off Switch Drain Capacitance	C _D (Off)				pF typ	f = 1 MHz
ADG726		137			pF typ	f = 1 MHz
ADG732		275			pF typ	f = 1 MHz
On Switch Drain, Source Capacitance	C _D , C _S (On)				pF typ	f = 1 MHz
ADG726		150			pF typ	f = 1 MHz
ADG732		300			pF typ	f = 1 MHz
POWER REQUIREMENTS						
Positive Supply Current	I _{DD}	10			μA typ	V _{DD} = 2.75 V
Negative Supply Current	I _{SS}	10	20	20	μA max	Digital inputs = 0 V or 2.75 V
			20	20	μA typ	V _{DD} = -2.75 V
					μA max	Digital inputs = 0 V or 2.75 V

¹ Guaranteed by design; not subject to production test.

TIMING CHARACTERISTICS

Table 4.

Parameter ^{1, 2, 3}	Limit at T _{MIN} , T _{MAX}	Unit	Test Conditions/Comments
t ₁	0	ns min	\overline{CS} to \overline{WR} setup time
t ₂	0	ns min	\overline{CS} to \overline{WR} hold time
t ₃	10	ns min	\overline{WR} pulse width
t ₄	10	ns min	Time between \overline{WR} cycles
t ₅	5	ns min	Address, enable setup time
t ₆	2	ns min	Address, enable hold time

¹ See Figure 3.

² All input signals are specified with t_r = t_f = 1 ns (10% to 90% of V_{DD}).

³ Guaranteed by design and characterization, not production tested.

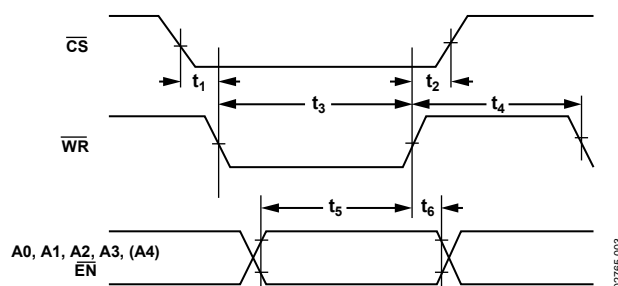

Figure 3. Timing Diagram

Figure 3 shows the timing sequence for latching the switch address and enable inputs. The latches are level sensitive; therefore, while \overline{WR} is held low, the latches are transparent and the switches respond to changing the address and enable the inputs.

Input data is latched on the rising edge of \overline{WR} . The ADG726 has two \overline{CS} inputs. This enables the device to be used either as a dual 16-to-1 channel multiplexer or a differential 16-channel multiplexer. If a differential output is required, tie \overline{CSA} and \overline{CSB} together.

ABSOLUTE MAXIMUM RATINGS

$T_A = 25^\circ\text{C}$, unless otherwise noted.

Table 5.

Parameter	Rating
V_{DD} to V_{SS}	7 V
V_{DD} to GND	-0.3 V to +7 V
V_{SS} to GND	+0.3 V to -7 V
Analog Inputs ¹	$V_{SS} - 0.3$ V to $V_{DD} + 0.3$ V or 30 mA, whichever occurs first
Digital Inputs ¹	-0.3 V to $V_{DD} + 0.3$ V or 30 mA, whichever occurs first
Peak Current, S or D (Pulsed at 1 ms, 10% Duty Cycle Maximum)	60 mA
Continuous Current, S or D	30 mA
Operating Temperature Range	
ADG726	-40°C to +85°C
ADG732	-40°C to +125°C
Storage Temperature Range	-65°C to +150°C
Junction Temperature	150°C
Thermal Impedance θ_{JA} (4-Layer Board)	
48-Lead LFCSP	25°C/W
48-Lead TQFP	54.6°C/W
Reflow Soldering Peak Temperature, Pb Free	As per JEDEC J-STD-020

¹ Overvoltages at A, \overline{EN} , \overline{WR} , \overline{CS} , S, or D will be clamped by internal diodes. Current should be limited to the maximum ratings given.

Stresses at or above those listed under Absolute Maximum Ratings may cause permanent damage to the product. This is a stress rating only; functional operation of the product at these or any other conditions above those indicated in the operational section of this specification is not implied. Operation beyond the maximum operating conditions for extended periods may affect product reliability.

ESD CAUTION



ESD (electrostatic discharge) sensitive device. Charged devices and circuit boards can discharge without detection. Although this product features patented or proprietary protection circuitry, damage may occur on devices subjected to high energy ESD. Therefore, proper ESD precautions should be taken to avoid performance degradation or loss of functionality.

PIN CONFIGURATIONS AND FUNCTION DESCRIPTION
48-LEAD TQFP

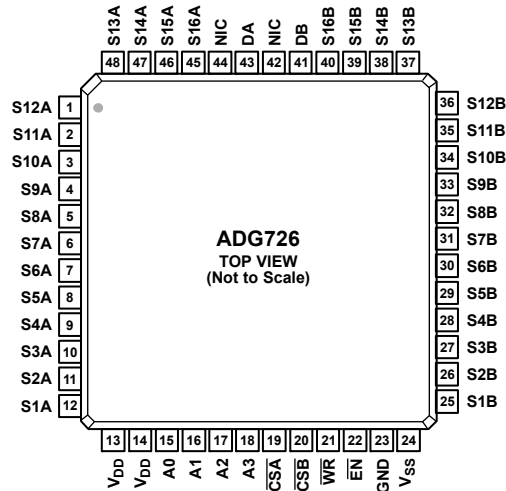

NOTES
 1. NIC = NOT INTERNALLY CONNECTED. DO NOT CONNECT TO THIS PIN.

Figure 4. ADG726 Pin Configuration

Table 6. ADG726 Pin Function Description

Pin No.	Mnemonic	Description
1 to 12, 45 to 48	S16A to S1A	Source Terminal. This pin may be an input or output.
13, 14	V _{DD}	Most Positive Power Supply Potential.
15 to 18	A0 to A3	Logic Control Inputs.
19	\overline{CSA}	Chip Select Pin A. \overline{CSA} is active low. If a differential output configuration is required, tie \overline{CSA} and \overline{CSB} together.
20	\overline{CSB}	Chip Select Pin B. \overline{CSB} is active low. If a differential output configuration is required, tie \overline{CSB} and \overline{CSA} together.
21	\overline{WR}	Write pin. When \overline{WR} is low, the logic control inputs (A0 to A3) control which state the switches are in. On the rising edge of \overline{WR} , the logic control input data is latched.
22	\overline{EN}	Active Low, Digital Input. When this pin is high, the device is disabled and all switches are off. When this pin is low, the Ax logic control inputs determine the on switches. The \overline{EN} input signal is not latched by \overline{WR} .
23	GND	Ground (0 V) Reference.
24	V _{SS}	Most Negative Power Supply in a Dual-Supply Application. In single-supply applications, connect this pin to GND.
25 to 40	S1B to S16B	Source Terminal. This pin may be an input or output.
41	DB	Drain Terminal. This pin may be an input or output.
42, 44	NIC	Not Internally Connected. Do not connect to this pin.
43	DA	Drain Terminal. This pin may be an input or output.

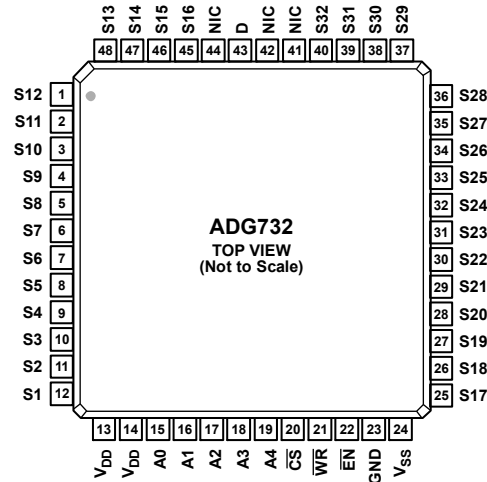

NOTES
 1. NIC = NOT INTERNALLY CONNECTED. DO NOT CONNECT TO THIS PIN.

Figure 5. ADG732 Pin Configuration

02765-104

Table 7. ADG732 Pin Function Description

Pin No.	Mnemonic	Description
1 to 12, 45 to 48	S16 to S1	Source Terminal. This pin may be an input or output.
13, 14	V _{DD}	Most Positive Power Supply Potential.
15 to 19	A0 to A4	Logic Control Inputs.
20	\overline{CS}	Chip Select Pin. \overline{CS} is active low.
21	\overline{WR}	Write Pin. When \overline{WR} is low, the logic control inputs (A0 to A4) control which state the switches are in. On the rising edge of \overline{WR} , the logic control input data is latched.
22	\overline{EN}	Active Low, Digital Input. When this pin is high, the device is disabled and all switches are off. When this pin is low, the A _x logic control inputs determine the on switches. The \overline{EN} input signal is not latched by \overline{WR} .
23	GND	Ground (0 V) Reference.
24	V _{SS}	Most Negative Power Supply in a Dual-Supply Application. In single-supply applications, connect this pin to GND.
25 to 40	S17 to S32	Source Terminal. This pin may be an input or output.
41, 42, 44	NIC	Not Internally Connected. Do not connect to this pin.
43	D	Drain Terminal. This pin may be an input or output.

48-LEAD LFCSP

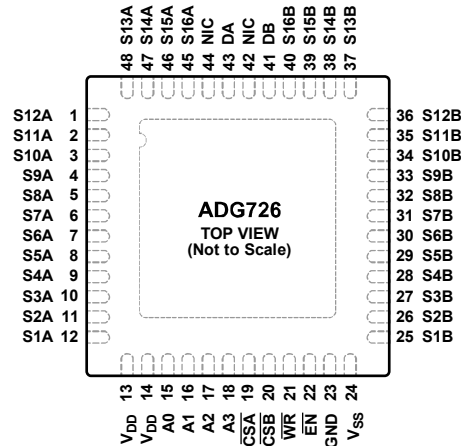

NOTES
 1. NIC = NOT INTERNALLY CONNECTED. DO NOT CONNECT TO THIS PIN.
 2. THE EXPOSED PAD MUST BE CONNECTED TO GND.

Figure 6. ADG726 Pin Configuration

Table 8. ADG726 Pin Function Description

Pin No.	Mnemonic	Description
1 to 12, 45 to 48	S16A to S1A	Source Terminal. This pin may be an input or output.
13, 14	V _{DD}	Most Positive Power Supply Potential.
15 to 18	A0 to A3	Logic Control Inputs.
19	\overline{CSA}	Chip Select Pin A. \overline{CSA} is active low. If a differential output configuration is required, tie \overline{CSA} and \overline{CSB} together.
20	\overline{CSB}	Chip Select Pin B. \overline{CSB} is active low. If a differential output configuration is required, tie \overline{CSB} and \overline{CSA} together.
21	\overline{WR}	Write pin. When \overline{WR} is low, the logic control inputs (A0 to A3) control which state the switches are in. On the rising edge of \overline{WR} , the logic control input data is latched.
22	\overline{EN}	Active Low, Digital Input. When this pin is high, the device is disabled and all switches are off. When this pin is low, the Ax logic control inputs determine the on switches. The EN input signal is not latched by \overline{WR} .
23	GND	Ground (0 V) Reference.
24	V _{SS}	Most Negative Power Supply in a Dual-Supply Application. In single-supply applications, connect this pin to GND.
25 to 40	S1B to S16B	Source Terminal. This pin may be an input or output.
41	DB	Drain Terminal. This pin may be an input or output.
42, 44	NIC	Not Internally Connected. Do not connect to this pin.
43	DA	Drain Terminal. This pin may be an input or output.
	EPAD	Exposed Pad. The exposed pad must be connected to GND.

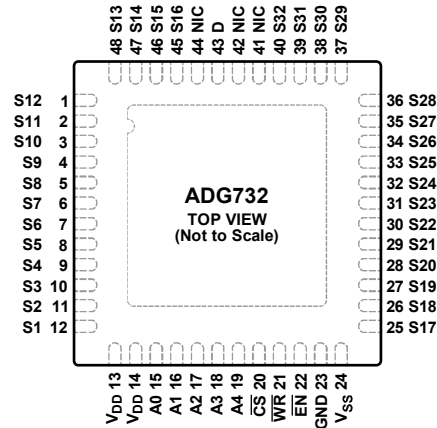

- NOTES**
1. NIC = NOT INTERNALLY CONNECTED. DO NOT CONNECT TO THIS PIN.
 2. THE EXPOSED PAD MUST BE CONNECTED TO GND.

02765-004

Figure 7. ADG732 Pin Configuration

Table 9. ADG732 Pin Function Description

Pin No.	Mnemonic	Description
1 to 12, 45 to 48	S16 to S1	Source Terminal. This pin may be an input or output.
13, 14	V _{DD}	Most Positive Power Supply Potential.
15 to 19	A0 to A4	Logic Control Inputs.
20	\overline{CS}	Chip Select Pin. \overline{CS} is active low.
21	\overline{WR}	Write Pin. When \overline{WR} is low, the logic control inputs (A0 to A4) control which state the switches are in. On the rising edge of \overline{WR} , the logic control input data is latched.
22	\overline{EN}	Active Low, Digital Input. When this pin is high, the device is disabled and all switches are off. When this pin is low, the Ax logic control inputs determine the on switches. The EN input signal is not latched by \overline{WR} .
23	GND	Ground (0 V) Reference.
24	V _{SS}	Most Negative Power Supply in a Dual-Supply Application. In single-supply applications, connect this pin to GND.
25 to 40	S17 to S32	Source Terminal. This pin may be an input or output.
41, 42, 44	NIC	Not Internally Connected. Do not connect to this pin.
43	D	Drain Terminal. This pin may be an input or output.
	EPAD	Exposed Pad. The exposed pad must be connected to GND.

Truth Tables

Table 10. ADG726 Truth Table

A3 ¹	A2 ¹	A1 ¹	A0 ¹	\overline{EN}^1	\overline{CSA}	\overline{CSB}	\overline{WR}^1	On Switch
X	X	X	X	X	1	1	L → H	Latches control input data
X	X	X	X	X	1	1	X	No change in switch condition
X	X	X	X	1	X	X	X	None
0	0	0	0	0	0	0	0	S1A to DA, S1B to DB
0	0	0	1	0	0	0	0	S2A to DA, S2B to DB
0	0	1	0	0	0	0	0	S3A to DA, S3B to DB
0	0	1	1	0	0	0	0	S4A to DA, S4B to DB
0	1	0	0	0	0	0	0	S5A to DA, S5B to DB
0	1	0	1	0	0	0	0	S6A to DA, S6B to DB
0	1	1	0	0	0	0	0	S7A to DA, S7B to DB
0	1	1	1	0	0	0	0	S8A to DA, S8B to DB
1	0	0	0	0	0	0	0	S9A to DA, S9B to DB
1	0	0	1	0	0	0	0	S10A to DA, S10B to DB
1	0	1	0	0	0	0	0	S11A to DA, S11B to DB
1	0	1	1	0	0	0	0	S12A to DA, S12B to DB

A3 ¹	A2 ¹	A1 ¹	A0 ¹	EN ¹	CSA	CSB	WR ¹	On Switch
1	1	0	0	0	0	0	0	S13A to DA, S13B to DB
1	1	0	1	0	0	0	0	S14A to DA, S14B to DB
1	1	1	0	0	0	0	0	S15A to DA, S15B to DB
1	1	1	1	0	0	0	0	S16A to DA, S16B to DB

¹ X is don't care, L is low, and H is high.

Table 11. ADG732 Truth Table

A4 ¹	A3 ¹	A2 ¹	A1 ¹	A0 ¹	EN ¹	CS	WR ¹	Switch Condition
X	X	X	X	X	X	1	L → H	Latches control input data
X	X	X	X	X	X	1	X	No change in switch condition
X	X	X	X	X	1	X	X	None
0	0	0	0	0	0	0	0	1
0	0	0	0	1	0	0	0	2
0	0	0	1	0	0	0	0	3
0	0	0	1	1	0	0	0	4
0	0	1	0	0	0	0	0	5
0	0	1	0	1	0	0	0	6
0	0	1	1	0	0	0	0	7
0	0	1	1	1	0	0	0	8
0	1	0	0	0	0	0	0	9
0	1	0	0	1	0	0	0	10
0	1	0	1	0	0	0	0	11
0	1	0	1	1	0	0	0	12
0	1	1	0	0	0	0	0	13
0	1	1	0	1	0	0	0	14
0	1	1	1	0	0	0	0	15
0	1	1	1	1	0	0	0	16
1	0	0	0	0	0	0	0	17
1	0	0	0	1	0	0	0	18
1	0	0	1	0	0	0	0	19
1	0	0	1	1	0	0	0	20
1	0	1	0	0	0	0	0	21
1	0	1	0	1	0	0	0	22
1	0	1	1	0	0	0	0	23
1	0	1	1	1	0	0	0	24
1	1	0	0	0	0	0	0	25
1	1	0	0	1	0	0	0	26
1	1	0	1	0	0	0	0	27
1	1	0	1	1	0	0	0	28
1	1	1	0	0	0	0	0	29
1	1	1	0	1	0	0	0	30
1	1	1	1	0	0	0	0	31
1	1	1	1	1	0	0	0	32

¹ X is don't care, L is low, and H is high.

TYPICAL PERFORMANCE CHARACTERISTICS

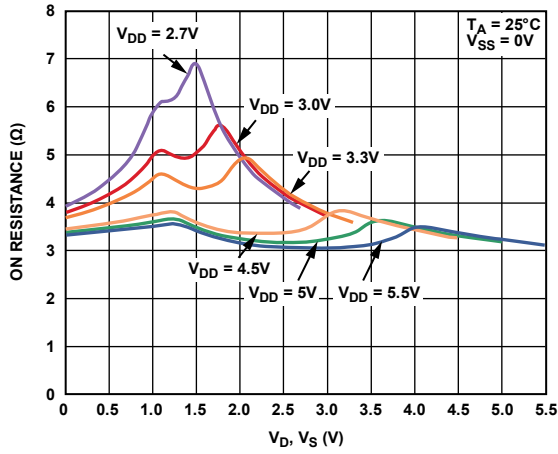

Figure 8. On Resistance vs. V_D (V_S), Single Supply

02765-006

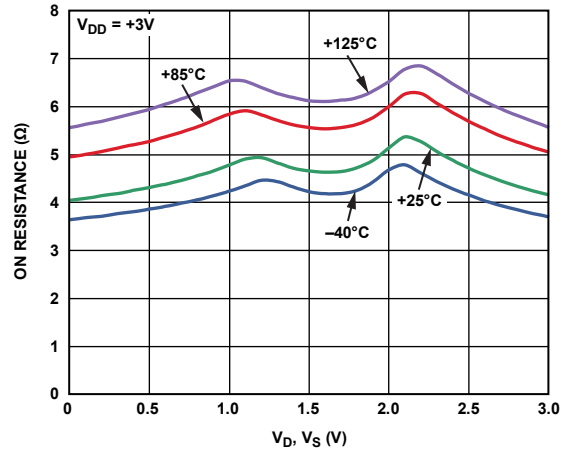

Figure 11. On Resistance vs. V_D (V_S), Single Supply

02765-009

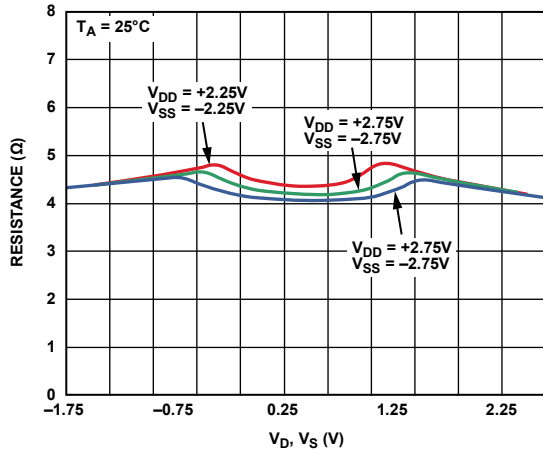

Figure 9. On Resistance vs. V_D (V_S), Dual Supply

02765-007

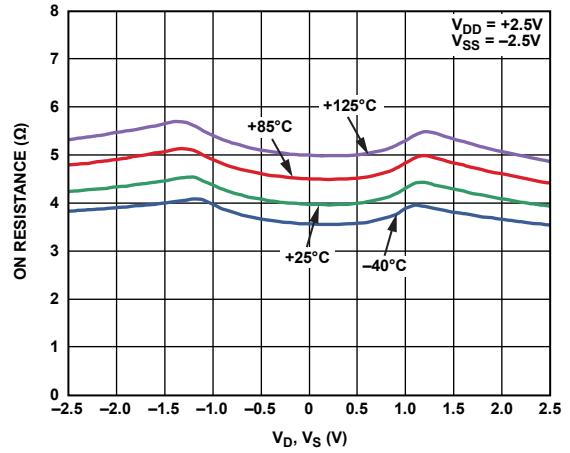

Figure 12. On Resistance vs. V_D (V_S), Dual Supply

02765-010

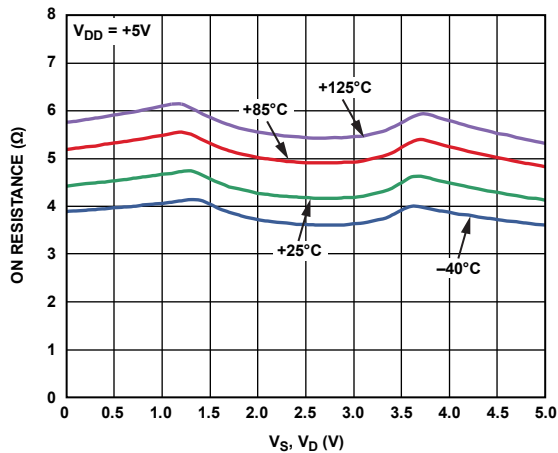

Figure 10. On Resistance vs. V_D (V_S) for Different Temperatures, Single Supply

02765-008

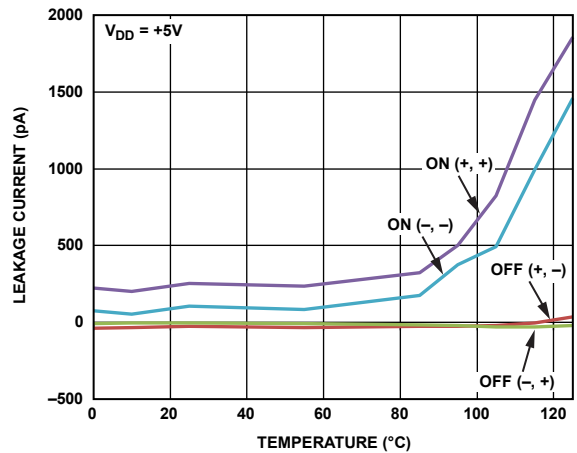

Figure 13. Leakage Currents vs. Temperature

02765-011

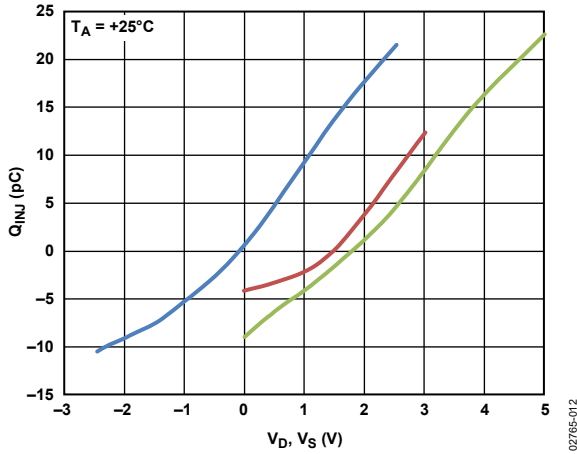

Figure 14. ADG732 Charge Injection (Q_{INJ}) vs. V_D , V_S

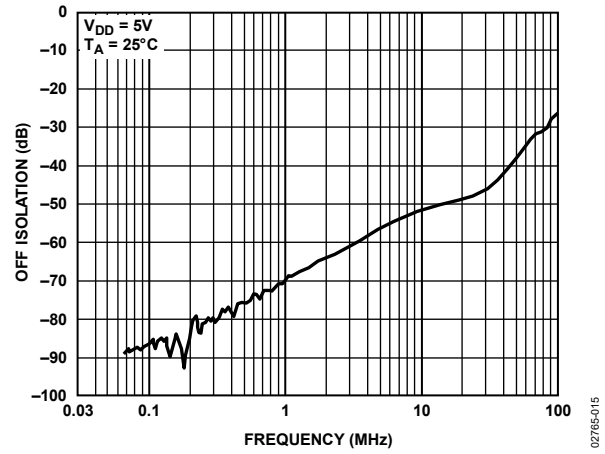

Figure 17. Off Isolation vs. Frequency

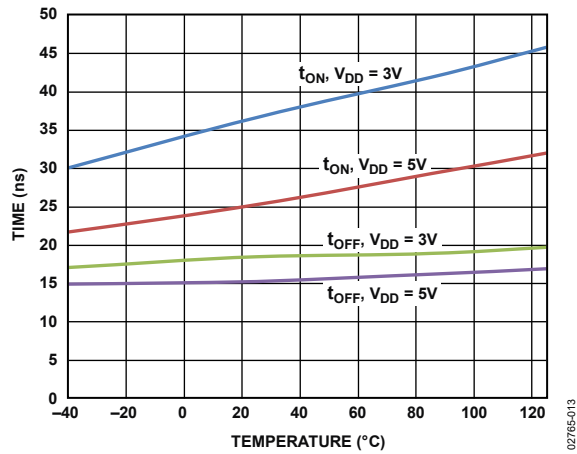

Figure 15. t_{ON}/t_{OFF} (\overline{EN}) Time vs. Temperature

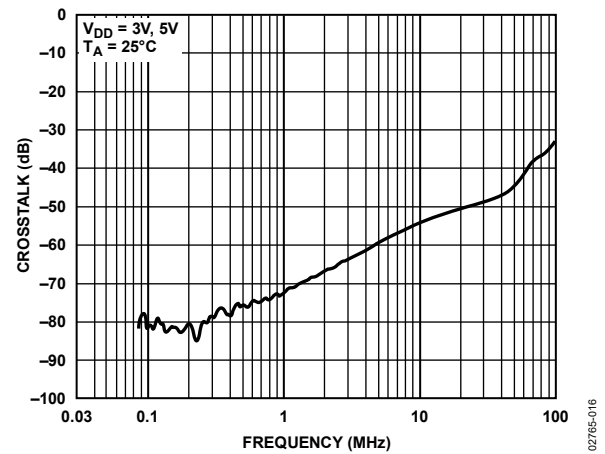

Figure 18. Crosstalk vs. Frequency

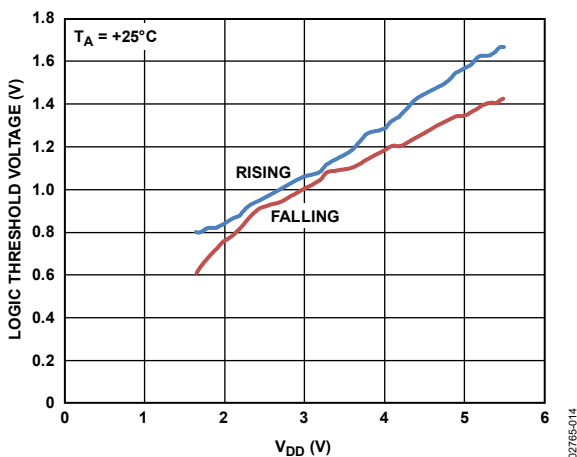

Figure 16. Logic Threshold Voltage vs. Supply Voltage (V_{DD})

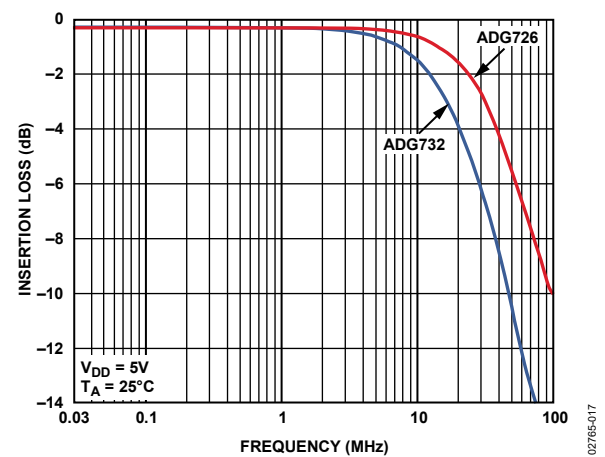

Figure 19. Insertion Loss vs. Frequency

TEST CIRCUITS

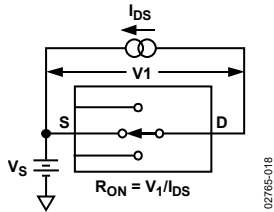

Figure 20. On Resistance

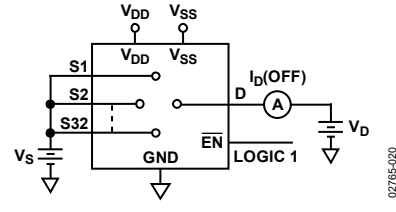

Figure 24. I_b (Off)

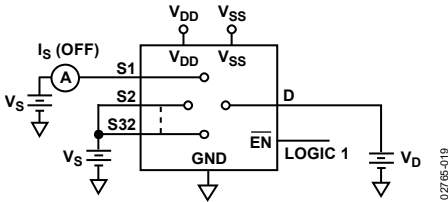

Figure 21. I_s (Off)

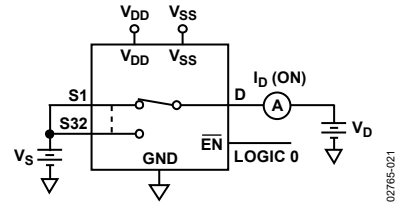
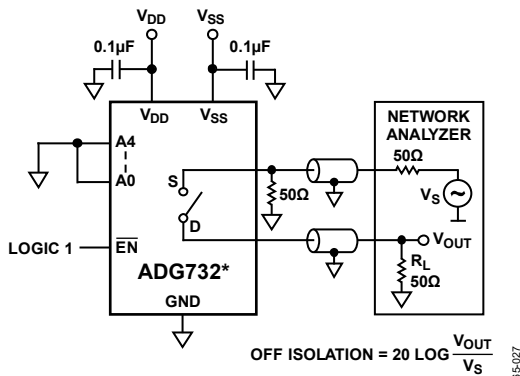
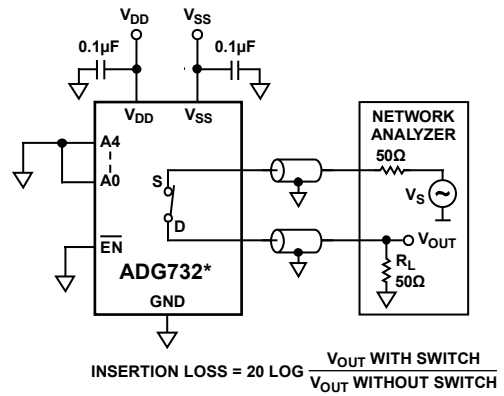

Figure 25. I_b (On)



*SIMILAR CONNECTION FOR ADG726.

Figure 22. Off Isolation



*SIMILAR CONNECTION FOR ADG726.

Figure 26. Bandwidth

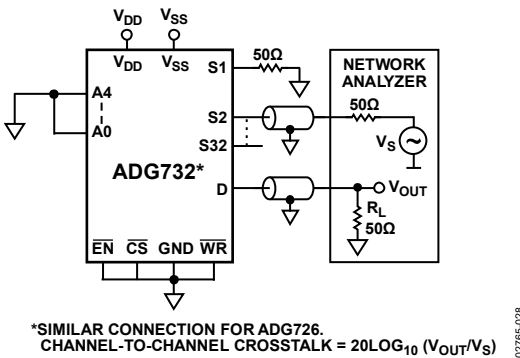

*SIMILAR CONNECTION FOR ADG726.
CHANNEL-TO-CHANNEL CROSSTALK = 20 LOG₁₀ (V_{OUT}/V_S)

Figure 23. Channel-to-Channel Crosstalk

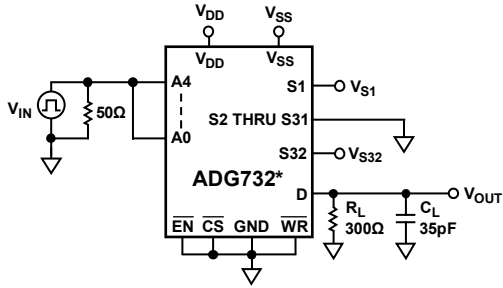

*SIMILAR CONNECTION FOR ADG726.

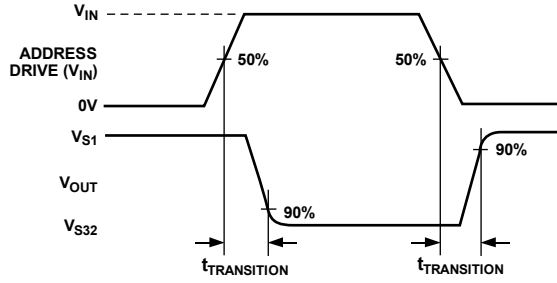

02765-022

Figure 27. Switching Time of Multiplexer, $t_{\text{TRANSITION}}$

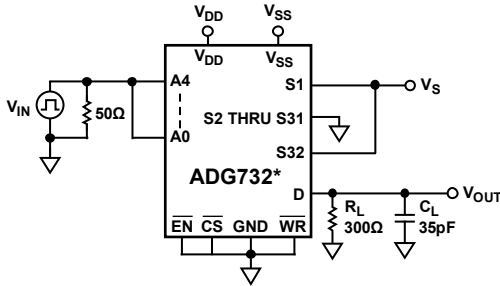

*SIMILAR CONNECTION FOR ADG726.

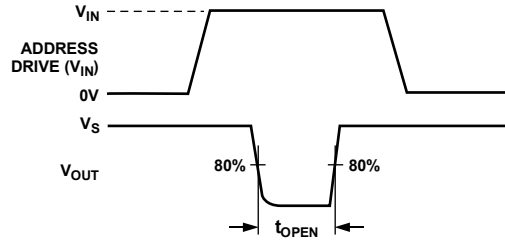

02765-023

Figure 28. Break-Before-Make Delay, t_{OPEN}

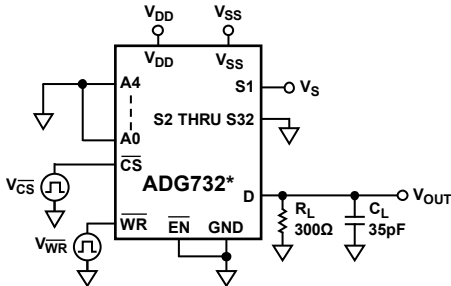

*SIMILAR CONNECTION FOR ADG726.

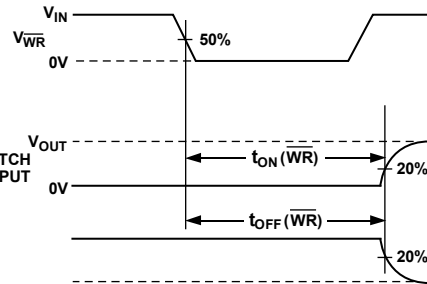

02765-024

Figure 29. Write Turn-On and Turn-Off Time, $t_{\text{ON}}(\overline{\text{WR}})$, $t_{\text{OFF}}(\overline{\text{WR}})$

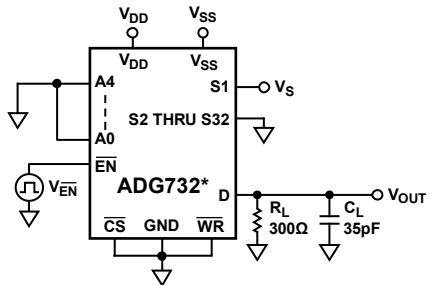

*SIMILAR CONNECTION FOR ADG726.

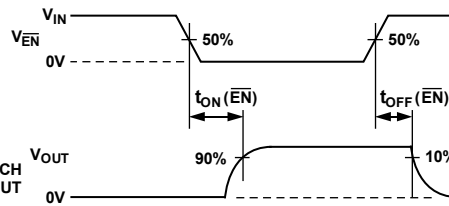

02765-025

Figure 30. Enable Delay, $t_{\text{ON}}(\overline{\text{EN}})$, $t_{\text{OFF}}(\overline{\text{EN}})$

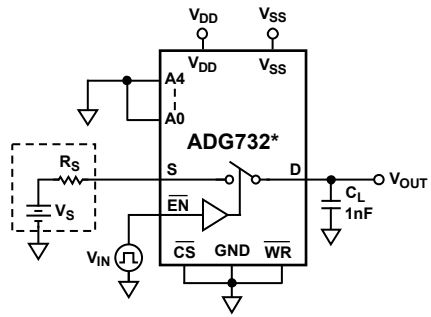

*SIMILAR CONNECTION FOR ADG726.

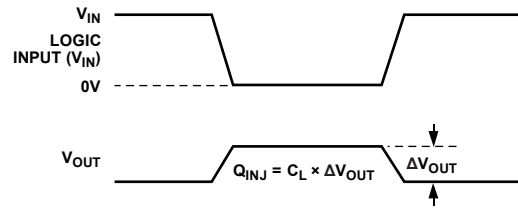

Figure 31. Charge Injection

02785-028

TERMINOLOGY

I_{DD}

I_{DD} represents the positive supply current.

I_{SS}

I_{SS} represents the negative supply current.

IN

IN represents the logic control input.

V_D (V_S)

V_D and V_S represent the analog voltage on the Dx pins and the Sx pins, respectively.

R_{ON}

R_{ON} represents the ohmic resistance between the Dx pins and the Sx pins.

ΔR_{ON}

ΔR_{ON} represents the difference between the R_{ON} of any two channels.

$R_{FLAT(ON)}$

$R_{FLAT(ON)}$ is the flatness that is defined as the difference between the maximum and minimum value of on resistance measured over the specified analog signal range.

I_S (Off)

I_S (Off) represents the source leakage current with the switch off.

I_D (Off)

I_D (Off) represents the drain leakage current with the switch off.

I_D (On), I_S (On)

I_D (On) and I_S (On) represent the channel leakage currents with the switch on.

V_{INL}

V_{INL} is the maximum input voltage for Logic 0.

V_{INH}

V_{INH} is the minimum input voltage for Logic 1.

I_{INL} , I_{INH}

I_{INL} and I_{INH} represent the low and high input currents of the digital inputs.

C_S (Off)

C_S (Off) represents the off switch source capacitance. It is measured with a reference to ground.

C_D (Off)

C_D (Off) represents the off switch drain capacitance. It is measured with reference to ground.

C_D (On), C_S (On)

C_D (On) and C_S (On) represent the on switch capacitances, which are measured with reference to ground.

C_{IN}

C_{IN} is the digital input capacitance.

$t_{TRANSITION}$

$t_{TRANSITION}$ is the delay time measured between the 50% and 90% points of the digital inputs and the switch on condition when switching from one address state to another.

t_{ON} (\overline{EN})

t_{ON} (\overline{EN}) is the delay time between the 50% and 90% points of the \overline{EN} digital input and the switch on condition.

t_{OFF} (\overline{EN})

t_{OFF} (\overline{EN}) is the delay time between the 50% and 90% points of the \overline{EN} digital input and the switch off condition.

t_{OPEN}

t_{OPEN} is the off time measured between the 80% points of both switches when switching from one address state to another

Charge Injection

Charge injection is a measure of the glitch impulse transferred from the digital input to the analog output during switching.

Off Isolation

Off isolation is a measure of the unwanted signal coupling through an off switch.

Channel-to-Channel Crosstalk

Crosstalk is a measure of unwanted signal that is coupled through from one channel to another as a result of parasitic capacitance.

Insertion Loss

Insertion loss is the loss due to the on resistance of the switch.

OUTLINE DIMENSIONS

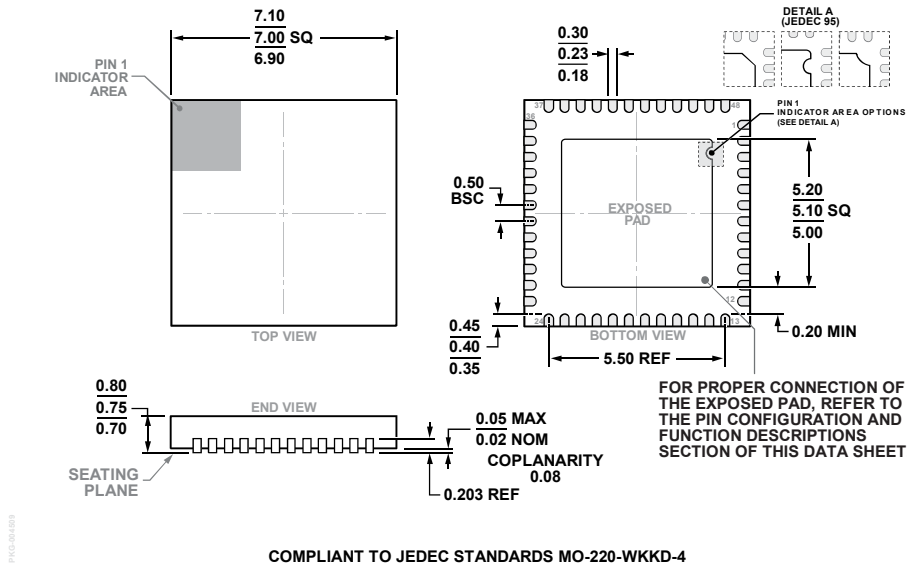

COMPLIANT TO JEDEC STANDARDS MO-220-WKGD-4

Figure 32. 48-Lead Frame Chip Scale Package [LFCSP]
7 mm × 7 mm Body and 0.75 mm Package Height
(CP-48-4)

Dimensions shown in millimeters

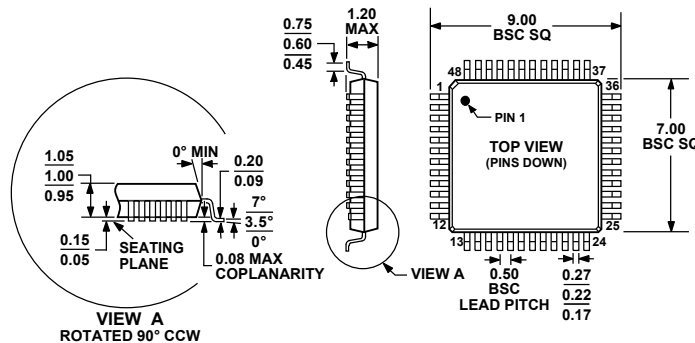

COMPLIANT TO JEDEC STANDARDS MS-026ABC

Figure 33. 48-Lead Thin Plastic Quad Flat Package [TQFP]
(SU-48)

Dimensions shown in millimeters

ORDERING GUIDE

Model ¹	Temperature Range	Package Description	Package Option
ADG726BCPZ	-40°C to +85°C	48-Lead Frame Chip Scale Package [LFCSP]	CP-48-4
ADG726BCPZ-REEL	-40°C to +85°C	48-Lead Frame Chip Scale Package [LFCSP]	CP-48-4
ADG726BSUZ	-40°C to +85°C	48-Lead Thin Plastic Quad Flat Package [TQFP]	SU-48
ADG726BSUZ-REEL	-40°C to +85°C	48-Lead Thin Plastic Quad Flat Package [TQFP]	SU-48
ADG732BCPZ	-40°C to +125°C	48-Lead Frame Chip Scale Package [LFCSP]	CP-48-4
ADG732BCPZ-REEL	-40°C to +125°C	48-Lead Frame Chip Scale Package [LFCSP]	CP-48-4
ADG732BSUZ	-40°C to +125°C	48-Lead Thin Plastic Quad Flat Package [TQFP]	SU-48
ADG732BSUZ-REEL	-40°C to +125°C	48-Lead Thin Plastic Quad Flat Package [TQFP]	SU-48

¹ Z = RoHS-Compliant Part