

FEATURES

High Off Isolation -75 dB at 100 MHz
-3 dB Signal Bandwidth 300 MHz
+1.8 V to +5.5 V Single Supply
Low On-Resistance (15 Ω)
Fast Switching Times
 t_{ON} Typically 9 ns
 t_{OFF} Typically 3 ns
Typical Power Consumption <0.01 μ W
TTL/CMOS Compatible

APPLICATIONS

Audio and Video Switching
RF Switching
Networking Applications
Battery Powered Systems
Communication Systems
Relay Replacement
Sample-and-Hold Systems

GENERAL DESCRIPTION

The ADG751 is a low voltage SPST (single pole, single throw) switch. It is constructed in a T-switch configuration, which results in excellent Off Isolation while maintaining good frequency response in the ON condition.

High off isolation and wide signal bandwidth make this part suitable for switching RF and video signals. Low power consumption and operating supply range of +1.8 V to +5.5 V make it ideal for battery powered, portable instruments.

The ADG751 is designed on a submicron process that provides low power dissipation yet gives high switching speed and low on resistance. This part is a fully bidirectional switch and can handle signals up to and including the supply rails.

The ADG751 is available in 6-lead SOT-23 and 8-lead μ SOIC packages.

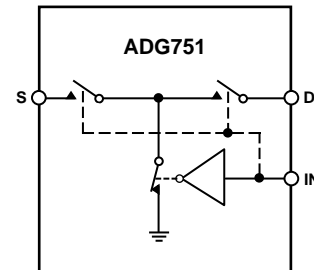
FUNCTIONAL BLOCK DIAGRAM

SWITCH SHOWN FOR A LOGIC "1" INPUT

PRODUCT HIGHLIGHTS

1. High Off Isolation -75 dB at 100 MHz.
2. -3 dB Signal Bandwidth 300 MHz.
3. Low On-Resistance (15 Ω).
4. Low Power Consumption, typically <0.01 μ W.
5. Tiny 6-lead SOT-23 and 8-lead μ SOIC packages.

REV. 0

Information furnished by Analog Devices is believed to be accurate and reliable. However, no responsibility is assumed by Analog Devices for its use, nor for any infringements of patents or other rights of third parties which may result from its use. No license is granted by implication or otherwise under any patent or patent rights of Analog Devices.

One Technology Way, P.O. Box 9106, Norwood, MA 02062-9106, U.S.A.
Tel: 781/329-4700 World Wide Web Site: <http://www.analog.com>
Fax: 781/326-8703 © Analog Devices, Inc., 1999

ADG751—SPECIFICATIONS ($V_{DD} = +5\text{ V} \pm 10\%$, $GND = 0\text{ V}$, unless otherwise noted.)

Parameter	B Grade		A Grade		Units	Test Conditions/Comments
	+25°C	-40°C to +85°C	+25°C	-40°C to +85°C		
ANALOG SWITCH						
Analogue Signal Range	0 V to V_{DD}		0 V to V_{DD}		V	
On-Resistance (R_{ON})	28		15		Ω typ	$V_S = 0\text{ V to }V_{DD}$, $I_{DS} = 10\text{ mA}$; Test Circuit 1
	35	40	18	20	Ω max	
On-Resistance Flatness ($R_{FLAT(ON)}$)	3		2		Ω typ	$V_S = 0\text{ V to }2.5\text{ V}$, $I_{DS} = 10\text{ mA}$
		5		3	Ω max	$V_{DD} = 4.5\text{ V}$
LEAKAGE CURRENTS						
Source OFF Leakage I_S (OFF)	± 0.01		± 0.01		nA typ	$V_{DD} = +5.5\text{ V}$ $V_D = 4.5\text{ V/1 V}$, $V_S = 1\text{ V/4.5 V}$; Test Circuit 2
	± 0.25	± 3.0	± 0.25	± 3.0	nA max	
Drain OFF Leakage I_D (OFF)	± 0.01		± 0.01		nA typ	$V_D = 4.5\text{ V/1 V}$, $V_S = 1\text{ V/4.5 V}$; Test Circuit 2
	± 0.25	± 3.0	± 0.25	± 3.0	nA max	
Channel ON Leakage I_D , I_S (ON)	± 0.01		± 0.01		nA typ	$V_D = V_S = 1\text{ V}$, or 4.5 V ; Test Circuit 3
	± 0.25	± 3.0	± 0.25	± 3.0	nA max	
DIGITAL INPUTS						
Input High Voltage, V_{INH}		2.4		2.4	V min	
Input Low Voltage, V_{INL}		0.8		0.8	V max	
Input Current						
I_{INL} or I_{INH}	0.001		0.001		μA typ	$V_{IN} = V_{INL}$ or V_{INH}
		± 0.5		± 0.5	μA max	
C_{IN} , Digital Input Capacitance	2		2		pF typ	
DYNAMIC CHARACTERISTICS¹						
t_{ON}	9		9		ns typ	$R_L = 300\ \Omega$, $C_L = 35\text{ pF}$; $V_S = 3\text{ V}$, Test Circuit 4
		13		13	ns max	
t_{OFF}	3		3		ns typ	$R_L = 300\ \Omega$, $C_L = 35\text{ pF}$; $V_S = 3\text{ V}$, Test Circuit 4
		5		5	ns max	
Charge Injection	1		1		pC typ	$V_S = 1\text{ V}$, $R_S = 0\ \Omega$, $C_L = 1.0\text{ nF}$; Test Circuit 5
Off Isolation	-75		-65		dB typ	$R_L = 50\ \Omega$, $C_L = 5\text{ pF}$, $f = 100\text{ MHz}$; Test Circuit 6
-3 dB Bandwidth	180		300		MHz typ	$R_L = 50\ \Omega$, $C_L = 5\text{ pF}$, Test Circuit 7
C_S (OFF)	4		4		pF typ	
C_D (OFF)	4		4		pF typ	
C_D , C_S (ON)	26		15		pF typ	
POWER REQUIREMENTS						
I_{DD}	0.001		0.001		μA typ	$V_{DD} = +5.5\text{ V}$ Digital Inputs = 0 V or +5.5 V
	0.1	0.5	0.1	0.5	μA max	

NOTES

¹Guaranteed by design, not subject to production test.

Specifications subject to change without notice.

SPECIFICATIONS ($V_{DD} = +3\text{ V} \pm 10\%$, $GND = 0\text{ V}$, unless otherwise noted.)

Parameter	B Grade		A Grade		Units	Test Conditions/Comments
	+25°C	-40°C to +85°C	+25°C	-40°C to +85°C		
ANALOG SWITCH						
Analog Signal Range		0 V to V_{DD}		0 V to V_{DD}	V	
On-Resistance (R_{ON})	60	90	35	50	Ω typ Ω max	$V_S = 0\text{ V to }V_{DD}$, $I_{DS} = -10\text{ mA}$; Test Circuit 1
LEAKAGE CURRENTS						
Source OFF Leakage I_S (OFF)	± 0.01		± 0.01		nA typ	$V_{DD} = +3.3\text{ V}$ $V_D = 3\text{ V}/1\text{ V}$, $V_S = 1\text{ V}/3\text{ V}$; Test Circuit 2
Drain OFF Leakage I_D (OFF)	± 0.25	± 3.0	± 0.25	± 3.0	nA max	
Channel ON Leakage I_D , I_S (ON)	± 0.01		± 0.01		nA typ	$V_D = 1\text{ V}/3\text{ V}$, $V_S = 3\text{ V}/1\text{ V}$; Test Circuit 2
	± 0.25	± 3.0	± 0.25	± 3.0	nA max	$V_D = V_S = 1\text{ V}$, or 3 V ; Test Circuit 3
DIGITAL INPUTS						
Input High Voltage, V_{INH}		2.0		2.0	V min	
Input Low Voltage, V_{INL}		0.4		0.4	V max	
Input Current						
I_{INL} or I_{INH}	0.001		0.001		μA typ	$V_{IN} = V_{INL}$ or V_{INH}
		± 0.5		± 0.5	μA max	
C_{IN} , Digital Input Capacitance	2		2		pF typ	
DYNAMIC CHARACTERISTICS¹						
t_{ON}	12		12		ns typ	$R_L = 300\ \Omega$, $C_L = 35\text{ pF}$;
		19		19	ns max	$V_S = 2\text{ V}$, Test Circuit 4
t_{OFF}	4		4		ns typ	$R_L = 300\ \Omega$, $C_L = 35\text{ pF}$;
		6		6	ns max	$V_S = 2\text{ V}$, Test Circuit 4
Charge Injection	1		1		pC typ	$V_S = 1\text{ V}$, $R_S = 0\ \Omega$, $C_L = 1.0\text{ nF}$; Test Circuit 5
Off Isolation	-75		-65		dB typ	$R_L = 50\ \Omega$, $C_L = 5\text{ pF}$, $f = 100\text{ MHz}$; Test Circuit 6
-3 dB Bandwidth	180		280		MHz typ	$R_L = 50\ \Omega$, $C_L = 5\text{ pF}$, Test Circuit 7
C_S (OFF)	4		4		pF typ	
C_D (OFF)	4		4		pF typ	
C_D , C_S (ON)	26		15		pF typ	
POWER REQUIREMENTS						
I_{DD}	0.001		0.001		μA typ	$V_{DD} = +3.3\text{ V}$ Digital Inputs = 0 V or +3.3 V
	0.1	0.5	0.1	0.5	μA max	

NOTES

¹Guaranteed by design, not subject to production test.

Specifications subject to change without notice.

ADG751

ABSOLUTE MAXIMUM RATINGS¹

(T_A = +25°C unless otherwise noted)

V _{DD} to GND	-0.3 V to +6 V
Analog, Digital Inputs ²	-0.3 V to V _{DD} +0.3 V or 30 mA, Whichever Occurs First
Peak Current, S or D	100 mA (Pulsed at 1 ms, 10% Duty Cycle Max)
Continuous Current, S or D	30 mA
Operating Temperature Range	
Industrial (A, B Versions)	-40°C to +85°C
Storage Temperature Range	-65°C to +150°C
Junction Temperature (T _J Max)	+150°C
Power Dissipation	(T _J Max - T _A) / θ _{JA}
μSOIC Package	
θ _{JA} Thermal Impedance	206°C/W
θ _{JC} Thermal Impedance	44°C/W

SOT-23 Package

θ _{JA} Thermal Impedance	229.6°C/W
θ _{JC} Thermal Impedance	91.99°C/W
Lead Temperature, Soldering	
Vapor Phase (60 sec)	+215°C
Infrared (15 sec)	+220°C

NOTES

¹Stresses above those listed under Absolute Maximum Ratings may cause permanent damage to the device. This is a stress rating only; functional operation of the device at these or any other conditions above those listed in the operational sections of this specification is not implied. Exposure to absolute maximum rating conditions for extended periods may affect device reliability. Only one absolute maximum rating may be applied at any one time.

²Overvoltages at IN, S or D will be clamped by internal diodes. Current should be limited to the maximum ratings given.

ORDERING GUIDE

Model	Temperature Range	Brand*	Package Descriptions	Package Options
ADG751BRM	-40°C to +85°C	SDB	μSOIC	RM-8
ADG751BRT	-40°C to +85°C	SDB	SOT-23	RT-6
ADG751ARM	-40°C to +85°C	SDA	μSOIC	RM-8
ADG751ART	-40°C to +85°C	SDA	SOT-23	RT-6

*Brand on these packages is limited to three characters due to space constraints.

CAUTION

ESD (electrostatic discharge) sensitive device. Electrostatic charges as high as 4000 V readily accumulate on the human body and test equipment and can discharge without detection. Although the ADG751 features proprietary ESD protection circuitry, permanent damage may occur on devices subjected to high energy electrostatic discharges. Therefore, proper ESD precautions are recommended to avoid performance degradation or loss of functionality.



PIN CONFIGURATIONS

8-Lead μ SOIC (RM-8)

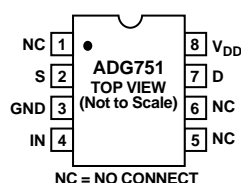

6-Lead SOT-23 (RT-6)

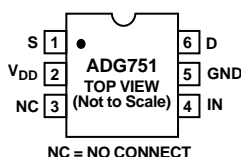

TERMINOLOGY

V_{DD}	Most positive power supply potential.
GND	Ground (0 V) reference.
S	Source terminal. May be an input or output.
D	Drain terminal. May be an input or output.
IN	Logic control input.
R_{ON}	Ohmic resistance between D and S.
$R_{FLAT(ON)}$	Flatness is defined as the difference between the maximum and minimum value of on resistance as measured over the specified analog signal range.
I_S (OFF)	Source leakage current with the switch "OFF."
I_D (OFF)	Drain leakage current with the switch "OFF."
I_D, I_S (ON)	Channel leakage current with the switch "ON."
V_D (V_S)	Analog voltage on terminals D and S.
C_S (OFF)	"OFF" switch source capacitance.
C_D (OFF)	"OFF" switch drain capacitance.
C_D, C_S (ON)	"ON" switch capacitance.
t_{ON}	Delay between applying the digital control input and the output switching on. See Test Circuit 4.
t_{OFF}	Delay between applying the digital control input and the output switching off.
Off Isolation	A measure of unwanted signal coupling through an "OFF" switch.
Charge Injection	A measure of the glitch impulse transferred from the digital input to the analog output during switching.
Bandwidth	The frequency at which the output is attenuated by -3 dBs.
On Response	The frequency response of the "ON" switch.
Insertion Loss	Loss due to the ON resistance of the switch.
V_{INL}	Maximum input voltage for Logic "0."
V_{INH}	Minimum input voltage for Logic "1."
$I_{INL}(I_{INH})$	Input current of the digital input.
I_{DD}	Positive supply current.

Table I. Truth Table

ADG751 IN	Switch Condition
0	ON
1	OFF

ADG751—Typical Performance Characteristics

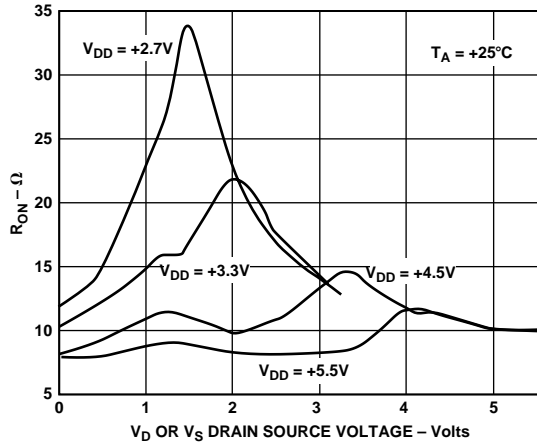

Figure 1. On Resistance as a Function of V_D (V_S) Single Supplies (A Grade)

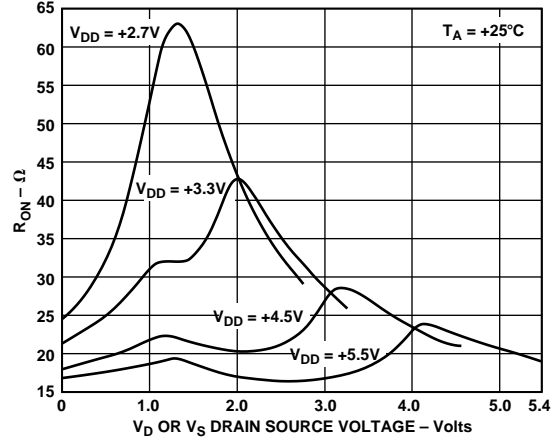

Figure 4. On Resistance as a Function of V_D (V_S) Single Supplies (B Grade)

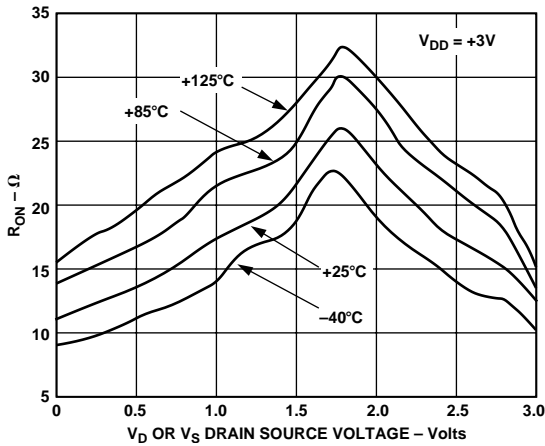

Figure 2. On Resistance as a Function of V_D (V_S) for Different Temperatures $V_{DD} = 3$ V (A Grade)

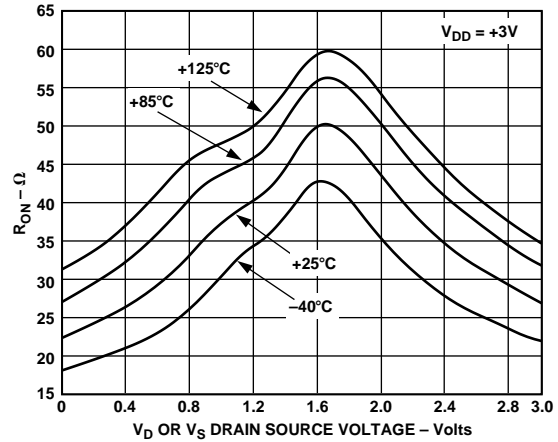

Figure 5. On Resistance as a Function of V_D (V_S) for Different Temperatures $V_{DD} = 3$ V (B Grade)

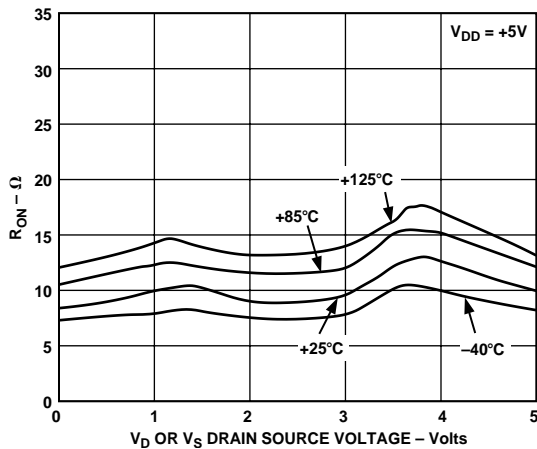

Figure 3. On Resistance as a Function of V_D (V_S) for Different Temperatures $V_{DD} = 5$ V (A Grade)

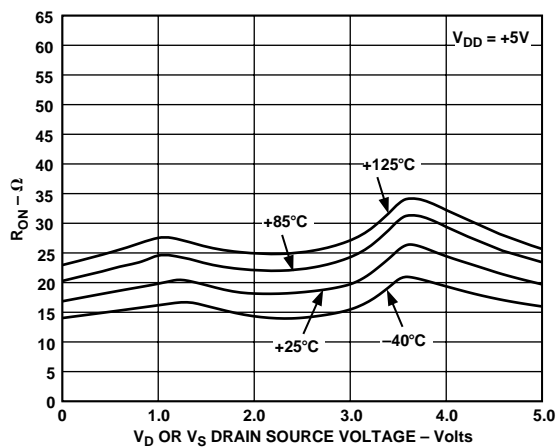

Figure 6. On Resistance as a Function of V_D (V_S) for Different Temperatures $V_{DD} = 5$ V (B Grade)

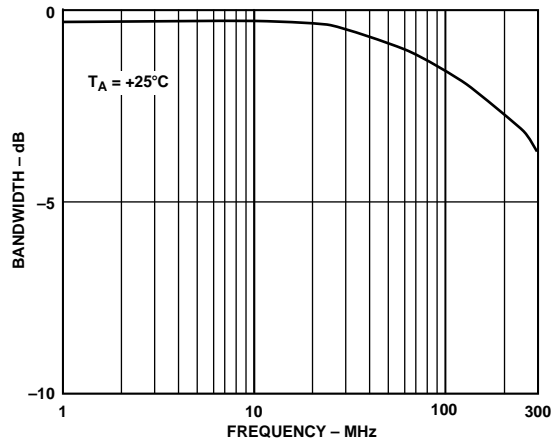

Figure 7. On Response vs. Frequency (A Grade)

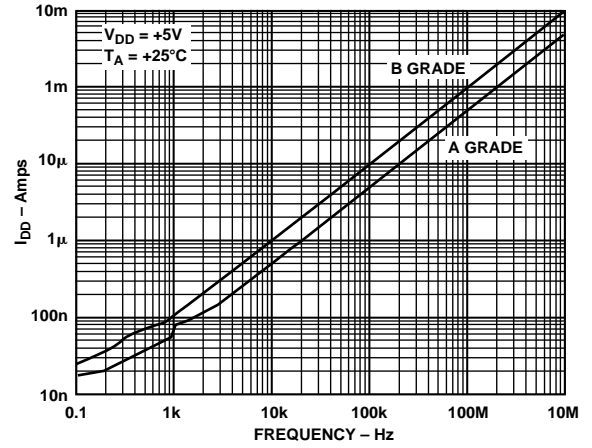

Figure 10. Supply Current vs. Input Switching Frequency

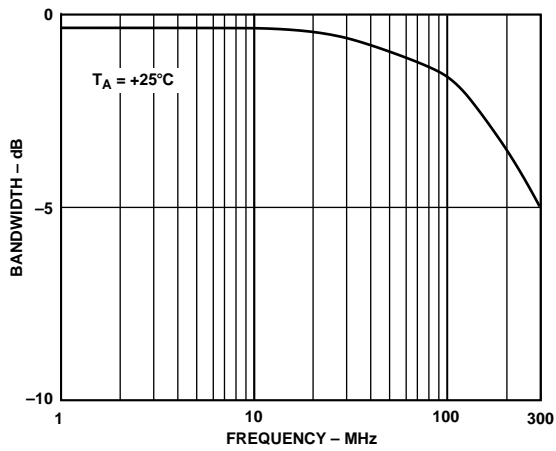

Figure 8. On Response vs. Frequency (B Grade)

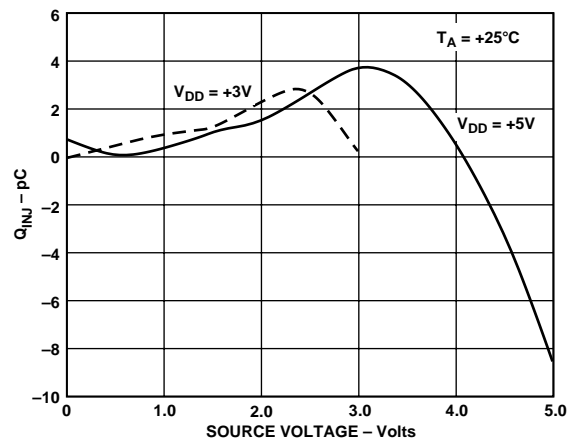

Figure 11. Charge Injection vs. Source/Drain Voltage

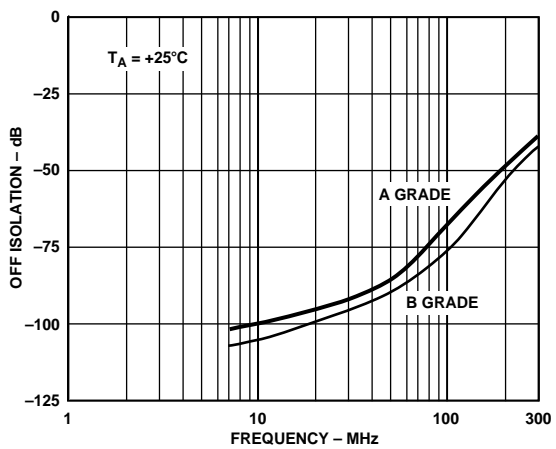

Figure 9. Off Isolation vs. Frequency for Both Grades

ADG751

GENERAL DESCRIPTION

The ADG751 is an SPST switch constructed using switches in a T configuration to obtain high “OFF” isolation while maintaining good frequency response in the “ON” condition.

Figure 12 shows the T-switch configuration. While the switch is in the OFF state, the shunt switch is closed and the two series switches are open. The closed shunt switch provides a signal path to ground for any of the unwanted signals that find their way through the off capacitances of the series’ MOS devices. This results in improved isolation between the input and output than with an ordinary series switch. When the switch is in the ON condition, the shunt switch is open and the signal path is through the two series switches which are now closed.

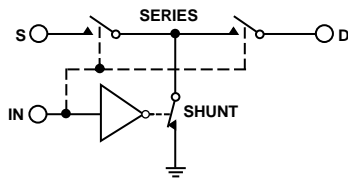

Figure 12. Basic T-Switch Configuration

LAYOUT CONSIDERATIONS

Where accurate high frequency operation is important, careful consideration should be given to the printed circuit board layout and to grounding. Wire wrap boards, prototype boards and sockets are not recommended because of their high parasitic inductance and capacitance. The part should be soldered directly to a printed circuit board. A ground plane should cover all unused areas of the component side of the board to provide a low impedance path to ground. Removing the ground planes from the area around the part reduces stray capacitance.

Good decoupling is important in achieving optimum performance. V_{DD} should be decoupled with a $0.1 \mu\text{F}$ surface mount capacitor to ground mounted as close as possible to the device itself.

Test Circuits

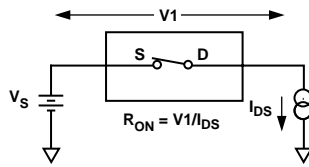

Test Circuit 1. On Resistance

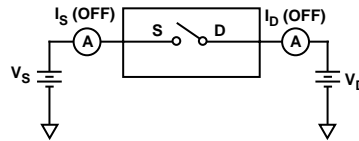

Test Circuit 2. Off Leakage

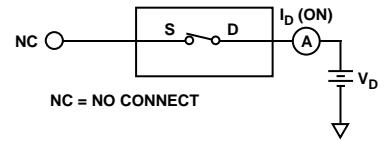

Test Circuit 3. On Leakage

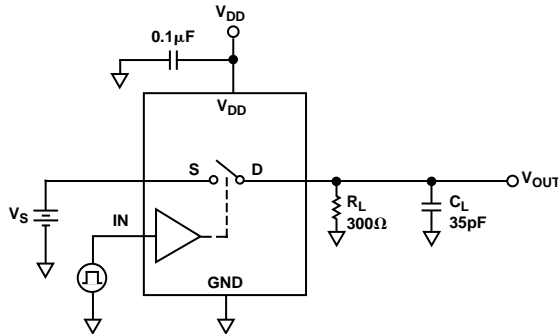

Test Circuit 4. Switching Times

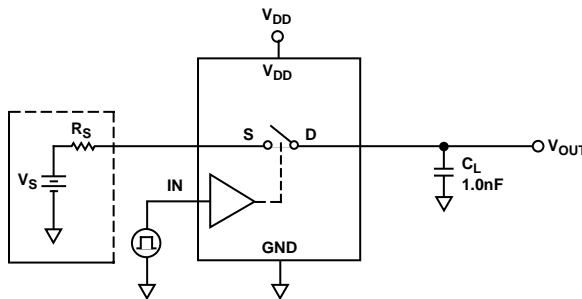

Test Circuit 5. Charge Injection

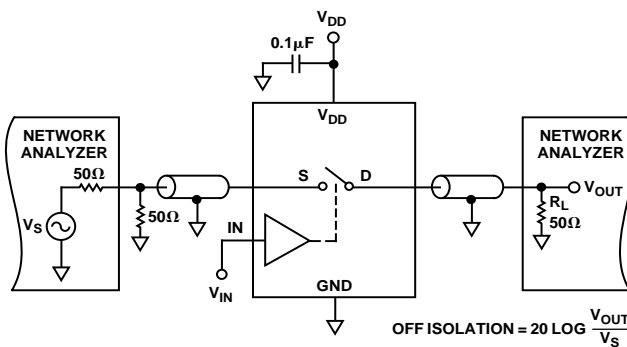

Test Circuit 6. Off Isolation

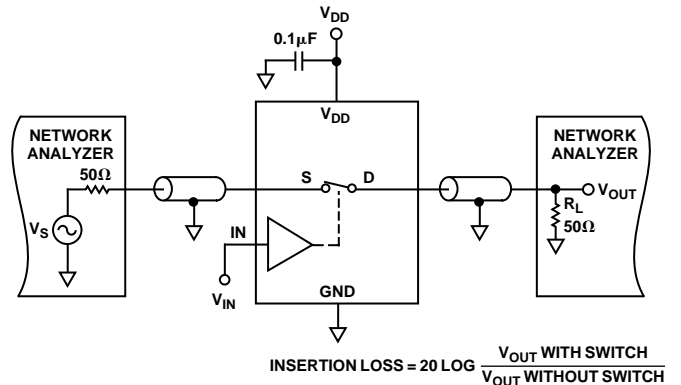

Test Circuit 7. Bandwidth

OUTLINE DIMENSIONS

Dimensions shown in inches and (mm).

8-Lead μ SOIC
(RM-8)

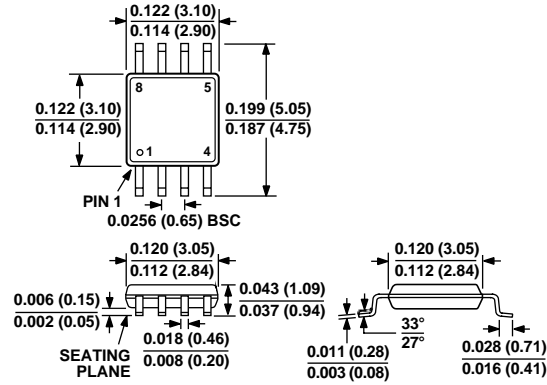

6-Lead SOT-23
(RT-6)

