

FEATURES

Dual output

RFOUT = 7.8 GHz to 8.8 GHz

RFOUT/2 = 3.9 GHz to 4.4 GHz

Very wide tuning range: VTUNE = 2 V to 18 V

High output power

RFOUT = 15 dBm

RFOUT/2 = 4 dBm

Low phase noise: -115 dBc/Hz @ 100 kHz offset

Current consumption: 300 mA typical

Small package: 32-lead 5 mm × 5 mm LFCSP

Flexible bias control allows either 5 V or 3 V operation

APPLICATIONS

Point-to-point radios

VSAT radios

Communications test equipment

GENERAL DESCRIPTION

The ADF5509 is a GaAs monolithic microwave integrated circuit (MMIC) voltage-controlled oscillator (VCO), packaged in an industry standard 32-lead 5 mm × 5 mm LFCSP package. The ADF5509 utilizes a push-push VCO architecture and outputs both the fundamental and half frequency output. The VCO's phase noise performance of -115 dBc/Hz at 100 kHz

offset allow it to meet the requirements of demanding radio systems like microwave point-to-point links. The divide-by-2 output can be input directly into Analog Devices, Inc., PLLs such as the ADF4156, ADF4106, or ADF4150HV. The ADF5509 operates off a 5 V supply and outputs 15 dBm typical.

FUNCTIONAL BLOCK DIAGRAM

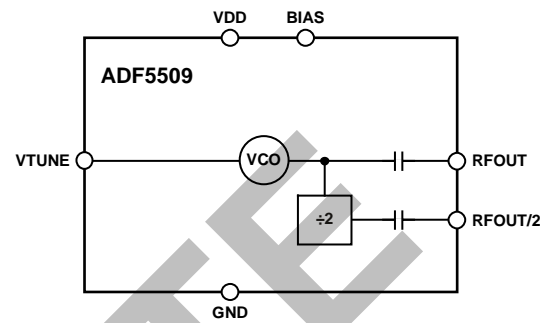

Figure 1.

11038-001

TABLE OF CONTENTS

Features.....	1	ESD Caution.....	4
Applications.....	1	Pin Configuration and Function Descriptions.....	5
General Description.....	1	Typical Performance Characteristics.....	6
Revision History.....	2	Application Circuit.....	9
Specifications.....	3	Outline Dimensions.....	10
Absolute Maximum Ratings.....	4	Ordering Guide.....	10

REVISION HISTORY

OBSOLETE

SPECIFICATIONS

VDD = 5 V \pm 10%, 3 V \pm 5%, GND = 0 V; dBm referred to 50 Ω ; T_A = T_{MIN} to T_{MAX}, unless otherwise noted. The operating temperature range is -40°C to +85°C.

Table 1.

Parameter	Min	Typ	Max	Unit	Test Conditions/Comments
RF CHARACTERISTICS					
Output Frequency: RFOUT	7.8		8.8	GHz	
Divide-by-2 Output Frequency: RFOUT/2	3.9		4.4	GHz	
5 V Operation					
Output Power: RFOUT	TBD	+15		dBm	
Output Power: RFOUT/2	TBD	+4		dBm	
Single Side Band Phase Noise		-115		dBc/Hz	VTUNE = 5 V, offset = 100 kHz
Single Side Band Phase Noise		-137		dBc/Hz	VTUNE = 5 V, offset = 1 MHz
3 V Operation					
Output Power: RFOUT	TBD	TBD		dBm	
Output Power: RFOUT/2	TBD	TBD		dBm	
Single Side Band Phase Noise		TBD		dBc/Hz	VTUNE = 5 V, offset = 100 kHz
Single Side Band Phase Noise		TBD		dBc/Hz	VTUNE = 5 V, offset = 1 MHz
Tune Voltage	2		18	V	
Tuning Port Leakage			TBD	μ A	VTUNE = 18 V
VCO Pushing		TBD		MHz/V	VTUNE = 5 V
VCO Pulling		TBD		MHz p-p	Into a 2:1 voltage standing wave ratio (VSWR)
Frequency Drift Rate			TBD	MHz/°C	
Output Return Loss		TBD		dB	
HARMONICS					
Subharmonic at RFOUT/2		-TBD		dBc	On the RFOUT pin
Second Harmonic Content		-TBD		dBc	
Third Harmonic Content		-TBD		dBc	
POWER SUPPLIES					
IDD					
5 V		300	TBD	mA	T _A = 25°C
3 V		TBD	TBD	mA	T _A = 25°C

ABSOLUTE MAXIMUM RATINGS

Table 2.

Parameter	Rating
VDD to GND	-0.3 V to +7.0 V
VTUNE to GND	0 V to 25 V
BIAS to GND	0 V to 3 V
Operating Temperature Range	-40°C to +85°C
Storage Temperature Range	-65°C to +150°C
Maximum Junction Temperature	150°C
LFCSP θ_{JA} Thermal Impedance ¹ (Paddle Soldered)	40.11°C/W
Peak Temperature	260°C
Time at Peak Temperature	40 sec

¹ Two signal planes (that is, on top and bottom surfaces of the board), two buried planes and nine vias.

Stresses above those listed under Absolute Maximum Ratings may cause permanent damage to the device. This is a stress rating only; functional operation of the device at these or any other conditions above those indicated in the operational section of this specification is not implied. Exposure to absolute maximum rating conditions for extended periods may affect device reliability.

This device is a high performance RF integrated circuit and is ESD sensitive. Proper precautions should be taken for handling and assembly.

ESD CAUTION



ESD (electrostatic discharge) sensitive device. Charged devices and circuit boards can discharge without detection. Although this product features patented or proprietary protection circuitry, damage may occur on devices subjected to high energy ESD. Therefore, proper ESD precautions should be taken to avoid performance degradation or loss of functionality.

PIN CONFIGURATION AND FUNCTION DESCRIPTIONS

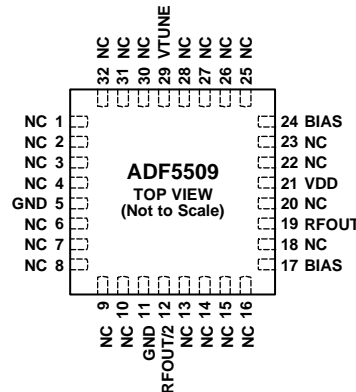

- NOTES**
1. PINS LABELED NC CAN BE ALLOWED TO FLOAT, BUT IT IS BETTER TO CONNECT THESE PINS TO GROUND. AVOID ROUTING HIGH SPEED SIGNALS THROUGH THESE PINS BECAUSE NOISE COUPLING MAY RESULT.
 2. THE LFCSP PACKAGE HAS AN EXPOSED PAD THAT MUST BE CONNECTED TO GND.

Figure 2. Pin Configuration

Table 3. Pin Function Descriptions

Pin No.	Mnemonic	Description
5, 11	GND	RF Ground. Tie all ground pins together.
12	RFOUT/2	Half-Frequency Output.
17, 24	BIAS	VCO Bias. Both pins should be connected together, see Figure 3 and Figure 4 for bias network.
19	RFOUT	Fundamental Frequency Output.
21	VDD	Voltage Supply for the VCO. Decouple this pin to ground with 120 pF, 1 nF, and 1 μF capacitors.
29	VTUNE	Tuning Port for the VCO.
1 to 4, 6 to 10, 13 to 16, 18, 20, 22, 23, 25 to 28, 30 to 32	NC	These pins are not connected internally (see Figure 2).
33	EP	Exposed Pad. The LFCSP package has an exposed pad that must be connected to GND.

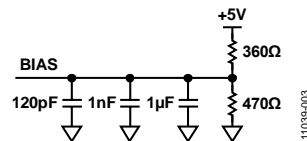

Figure 3. Bias Network for 5 V Operation

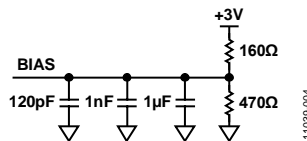

Figure 4. Bias Network for 3 V Operation

TYPICAL PERFORMANCE CHARACTERISTICS

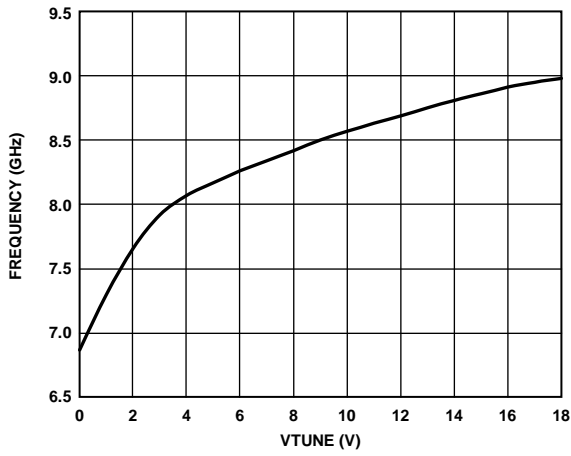

Figure 5. Frequency vs. Tuning Voltage

11038-005

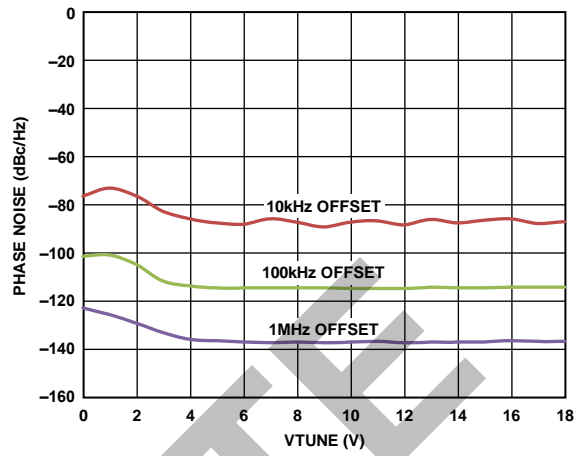

Figure 8. Phase Noise vs. Tuning Voltage

11038-008

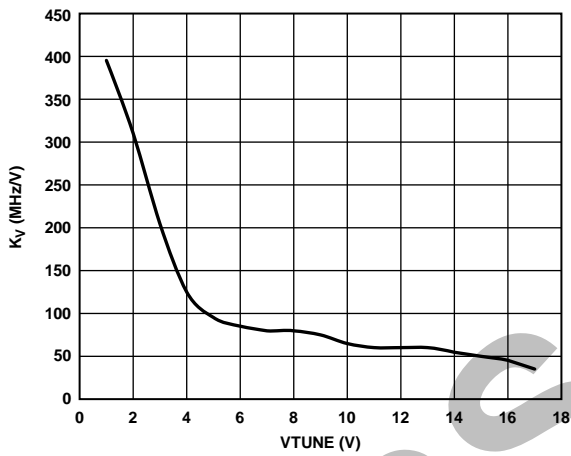

Figure 6. Sensitivity vs. Tuning Voltage

11038-006

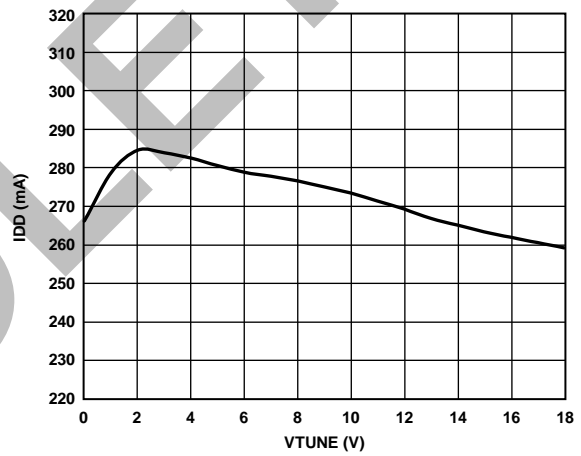

Figure 9. IDD vs. Tuning Voltage

11038-009

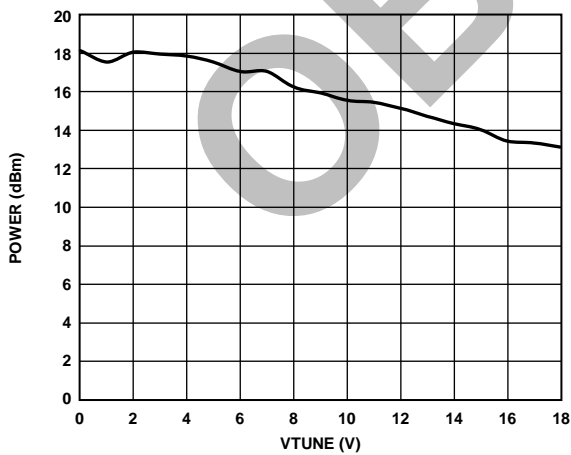

Figure 7. Output Power vs. Tuning Voltage

11038-007

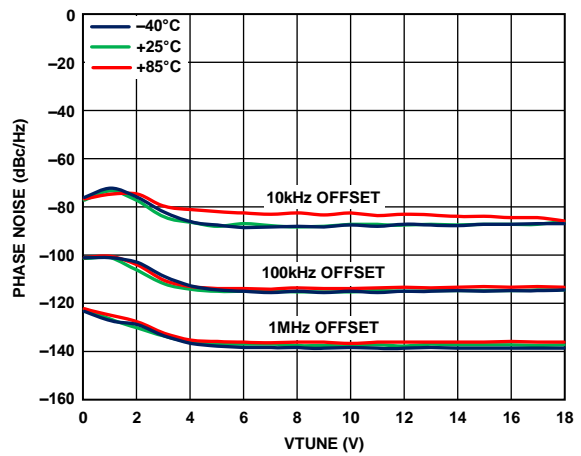

Figure 10. Phase Noise vs. Temperature

11038-010

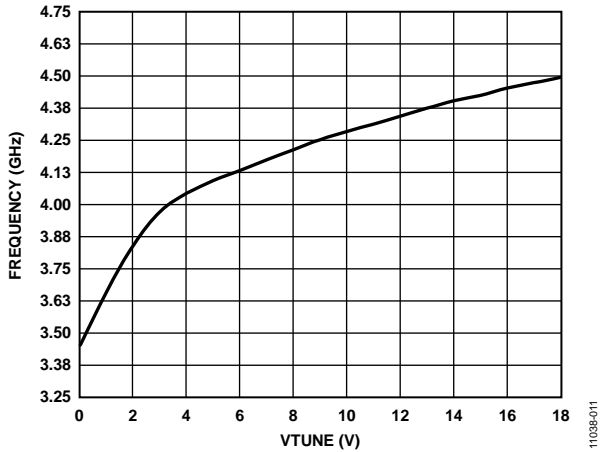

Figure 11. RFOUT/2 Frequency vs. Tuning Voltage

11038-011

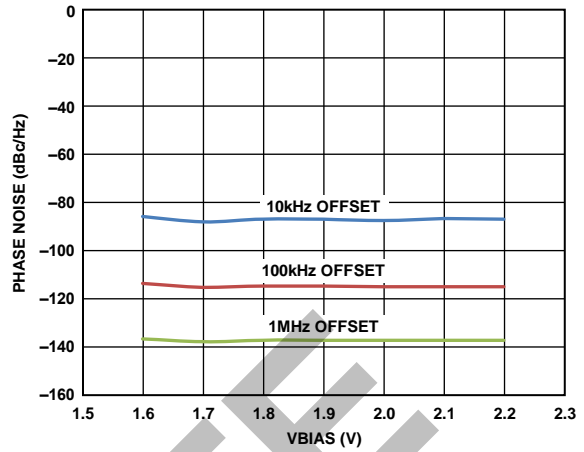

Figure 14. Phase Noise vs. VBIAS with VTUNE = 6 V

11038-020

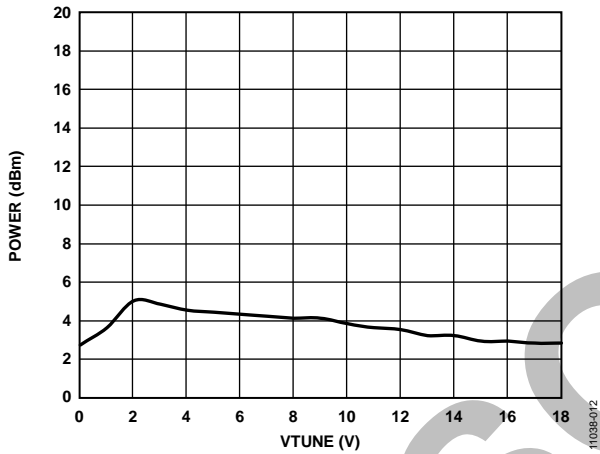

Figure 12. RFOUT/2 Output Power vs. Tuning Voltage

11038-012

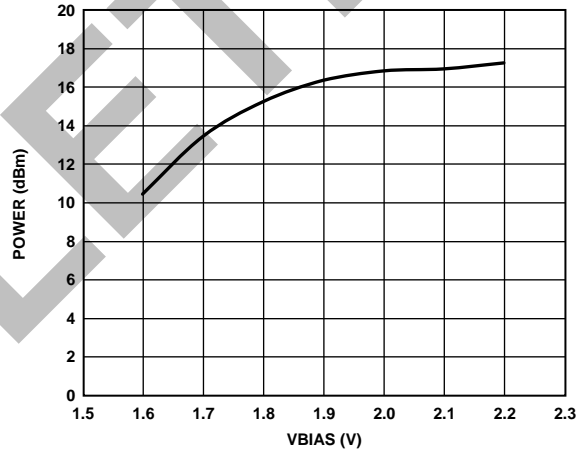

Figure 15. Output Power vs. VBIAS with VTUNE = 6 V

11038-021

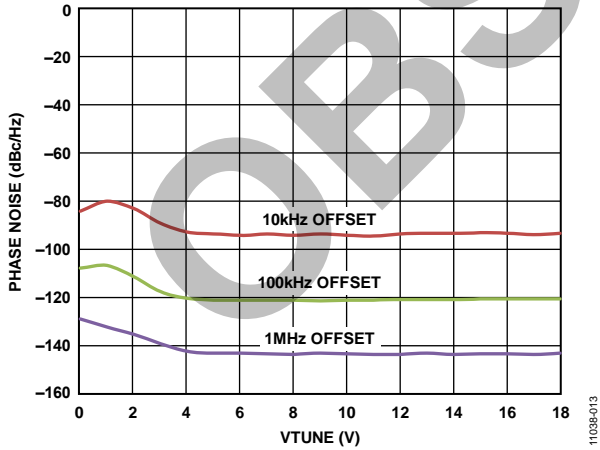

Figure 13. RFOUT/2 Phase Noise vs. Tuning Voltage

11038-013

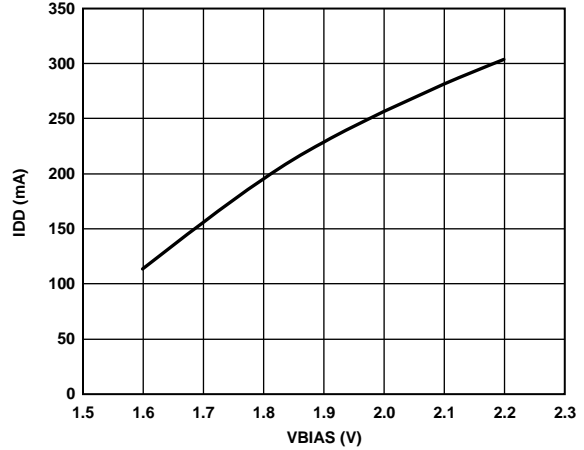

Figure 16. IDD vs. VBIAS with VTUNE = 6 V

11038-022

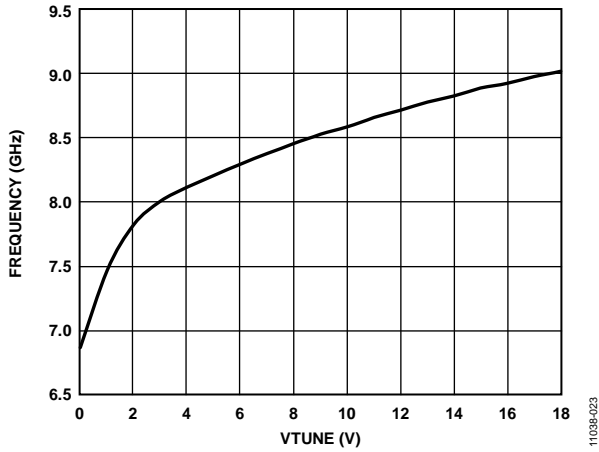

Figure 17. Frequency vs. Tuning Voltage with VDD = 3V

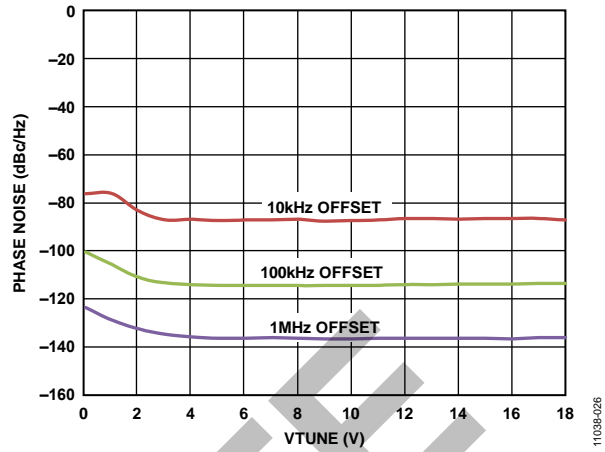

Figure 20. Phase Noise vs. Tuning Voltage with VDD = 3V

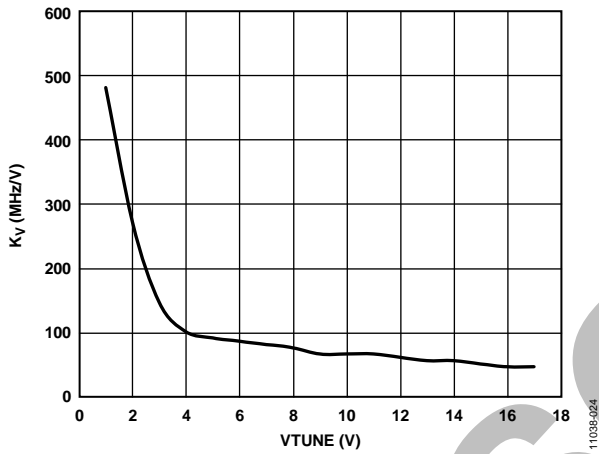

Figure 18. Sensitivity vs. Tuning Voltage with VDD = 3V

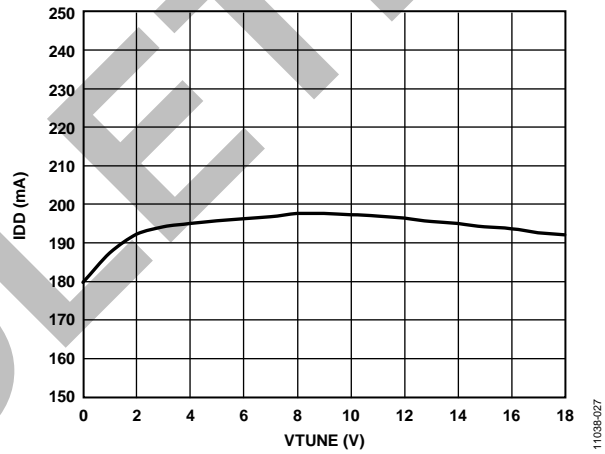

Figure 21. IDD vs. Tuning Voltage with VDD = 3V

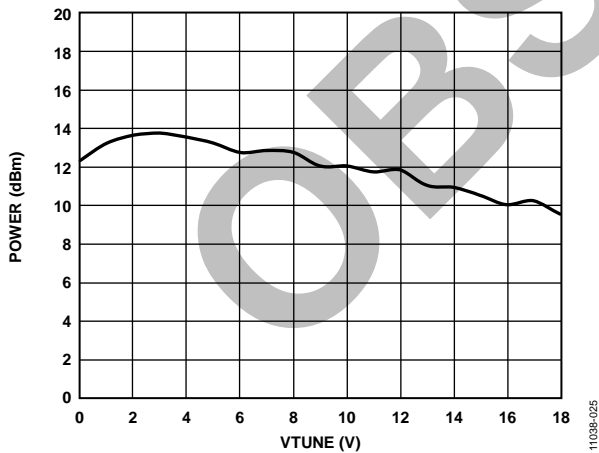

Figure 19. Output Power vs. Tuning Voltage with VDD = 3V

APPLICATION CIRCUIT

The **ADF5509** can be operated in a PLL loop with several of the Analog Devices PLL family of ICs by using the divide-by-2 output from the VCO.

A simple interface is shown in Figure 22 using the **ADF4108** high frequency PLL to drive the **ADF5509**. An active filter topology, using the **OP184** op amp, can be used to provide the wide tuning range required by the **ADF5509**. The positive input pin of the **OP184** is biased at half the **ADF4108** charge pump supply (V_P). This can be easily achieved using a simple resistor

divider, ensuring sufficient decoupling close to the +IN A pin of the **OP184**, thereby allowing the use of a single positive supply for the op amp.

To achieve the best performance of the **ADF5509**, take care in the power management design. On the **ADF5509** evaluation board, the **ADP7104** low noise LDO is used to provide the 5 V power supply to the part and provide the voltage for the resistor divider network for the BIAS pin.

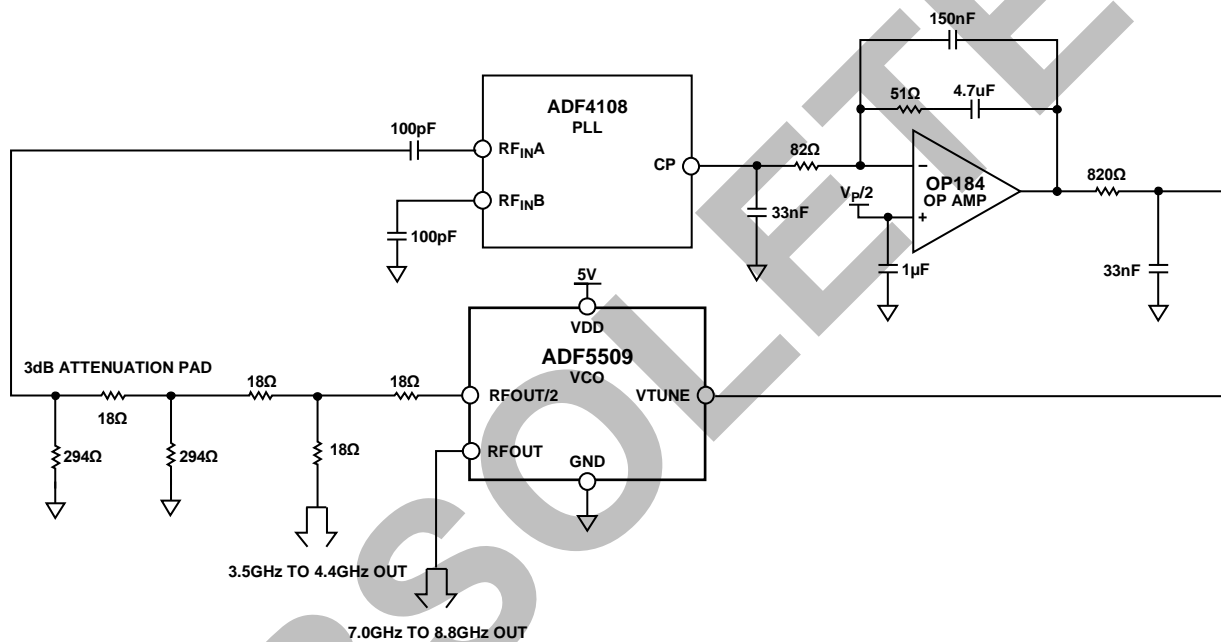
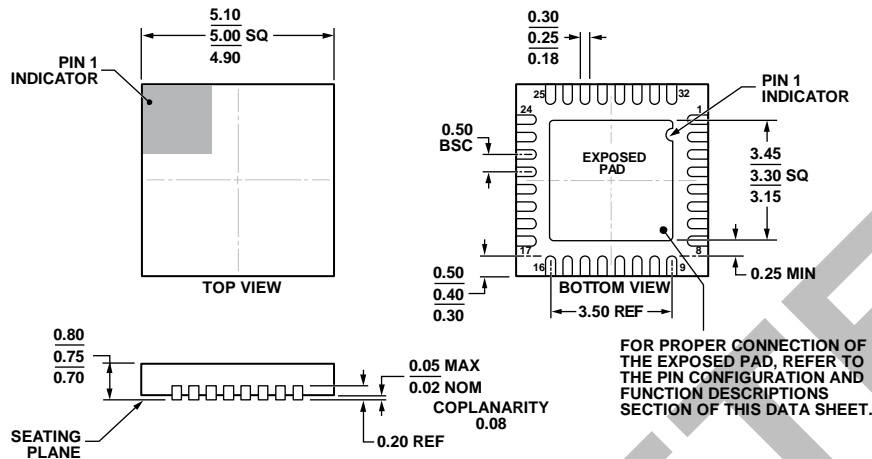

Figure 22. **ADF5509** used with **ADF4108** in a Microwave 8.0 GHz PLL Loop

110386-014

OUTLINE DIMENSIONS



COMPLIANT TO JEDEC STANDARDS MO-220-WHHD.

Figure 23. 32-Lead Lead Frame Chip Scale Package [LFCSP_WQ]
 5 mm × 5 mm Body, Very Very Thin Quad
 (CP-32-13)
 Dimensions shown in millimeters

ORDERING GUIDE

Model ¹	Temperature Range	Package Description	Package Option
ADF5509BCPZ-U2	-40°C to +85°C	32-Lead Lead Frame Chip Scale Package (LFCSP_WQ)	CP-32-13
EV-ADF5509EB2Z-U2		Evaluation Board	

¹ Z = RoHS Compliant Part.

NOTES

OBSOLETE

NOTES

OBSOLETE