

DESCRIPTION

Demonstration circuit DC1601A is a poly-phase power supply featuring the LTM4607 Power module, a complete high efficiency switching mode buck-boost power supply. The DC1601A input voltage range is from 6V to 36V and is capable of delivering high power through paralleled LTM4607 modules. The demo circuit can deliver up to 10A of output current for 2 paralleled modules (DC1601A-A), 15A for 3 paralleled modules (DC1601A-B) and up to 20A for 4 paralleled modules (DC1601A-C). The DC1601A demonstrates that paralleling modules is easy and reliable.

The output voltage for the board is 12V. The rated load current per module is 5A, however current de-rating may be necessary under certain V_{IN} , V_{OUT} , frequency, and thermal conditions. An on-board external clock is provided for synchronization and interleaving of phases to minimize input and output ripple. An internal phase-

locked loop allows the LTM4607 to be synchronized to an external clock within the range of 200 kHz to 400 kHz.

The LTM4607 default switching frequency on the DC1601A is set to 300 kHz through the on-board LTC6902 clock generator which interleaves the paralleled phases. The frequency and phase separation set by the LTC6902 are resistor programmable.

These features, including the availability of the LTM4607 in a compact thermally enhanced 15mmx15mmx2.8mm LGA package make the demonstration circuit ideal for use in high-density point of load regulation applications.

Design files for this circuit board are available. Call the LTC Factory.

 , LTC, LT and LTM are registered trademarks of Linear Technology Corporation.

Table 1. Performance Summary

PARAMETER	CONDITIONS / NOTES	VALUE
Maximum Input Voltage		36V
Minimum Input Voltage		6V
Output Voltage V_{OUT}	Programmed by R22	12V
Maximum Continuous Output Current I_{OUT} MAX	Current de-rating may be necessary for certain V_{IN} , V_{OUT} , frequency and thermal conditions.	10A _{DC} (DC1601A-A) 15A _{DC} (DC1601A-B) 20A _{DC} (DC1601A-C)
Default Operating Frequency		300kHz
External Clock Sync. frequency range		200kHz – 400kHz
Output voltage ripple (typical)	$V_{OUT} = 12V$ 300kHz (20MHz BW)	$V_{IN} = 9V, I_{OUT} = 10A$ (DC1601A-A), See Fig. 5a $V_{IN} = 12V, I_{OUT} = 15A$ (DC1601A-B), See Fig. 5b $V_{IN} = 32V, I_{OUT} = 20A$ (DC1601A-C), See Fig. 5c
Efficiency	$V_{IN} = 9V, V_{OUT} = 12V$ 300kHz	95.7% @ $I_{OUT} = 10A$ (DC1601A-A), See Fig. 2a 94.8% @ $I_{OUT} = 15A$ (DC1601A-B), See Fig. 2b 94.8% @ $I_{OUT} = 20A$ (DC1601A-C), See Fig. 2c
Load Transient	$V_{OUT} = 12V$ 300kHz (20MHz BW)	$V_{IN} = 9V, I_{OUT} = 10A$ (DC1601A-A), See Fig. 4a $V_{IN} = 12V, I_{OUT} = 15A$ (DC1601A-B), See Fig. 4b $V_{IN} = 32V, I_{OUT} = 20A$ (DC1601A-B), See Fig. 4c

QUICK START PROCEDURE

Demonstration circuit DC1601A is easy to set up to evaluate the performance of paralleled LTM4607 modules. Please refer to Figure 1 for proper measurement equipment setup and follow the procedure below:

1. With power off, connect the input power supply, load, and meters as shown in Figure 1. Preset the load to 0A and V_{IN} supply to be 0V. Place jumpers in the following positions for a typical $12V_{OUT}$ application:

JP2	JP1	JP3
MODE	RUN	START
CCM	OFF	SSO

2. Turn on the power at the input. Increase V_{IN} to 18V (Do not hot-plug the input supply or apply more than the rated maximum voltage of 36V

to the board or the modules may be damaged).

3. Set the run pin jumper (JP1) to the ON position. The output voltage should be regulated. The output voltage meter should read $12V \pm 2\%$ (11.76V-12.24V).
4. Vary the input voltage from 6V-36V and adjust the load current from 0-10A (for DC1601A-A), 0-15A (for DC1601A-B), 0-20A (for DC1601A-C). V_{OUT} should remain regulated at $12V \pm 2\%$ (11.76V-12.24V). Observe the load regulation, efficiency and other parameters.
5. Set the load current to 0A. Set the RUN pin jumper (JP1) to the OFF position. Turn off input supply before disconnecting the circuit.

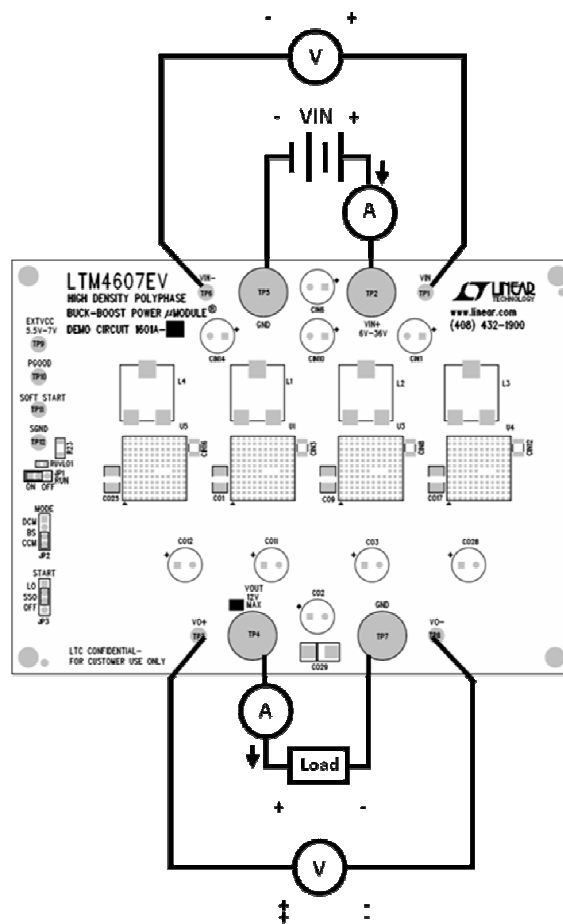

Figure 1.

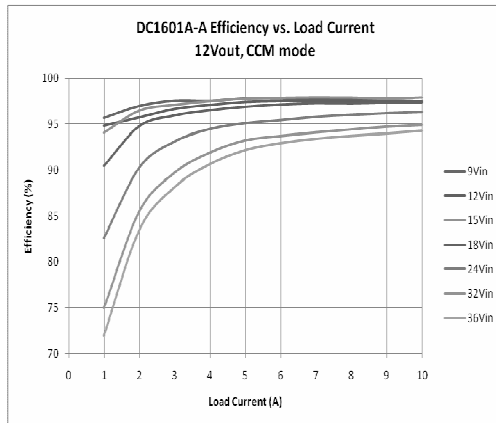

Figure 2a: Measured Efficiency at 12V_{OUT}, 300 kHz (DC1601A-A)

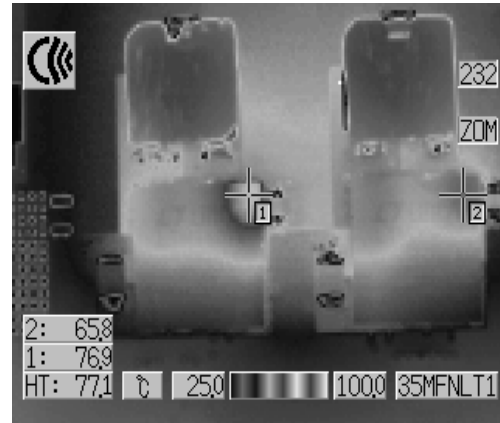

Figure 3a: Thermal capture at 6V_{IN}, 12V_{OUT}, 10A, 300kHz (DC1601A-A)
No Forced Airflow (Convection)

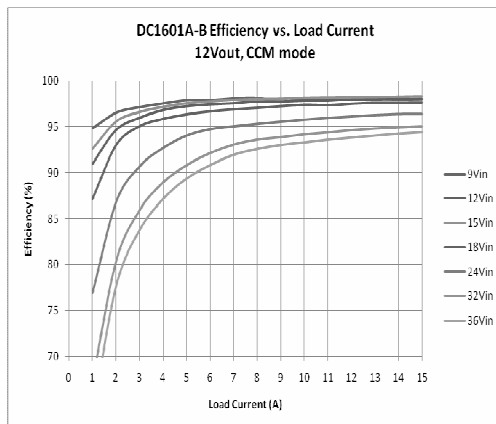

Figure 2b: Measured Efficiency at 12V_{OUT}, 300 kHz (DC1601A-B)

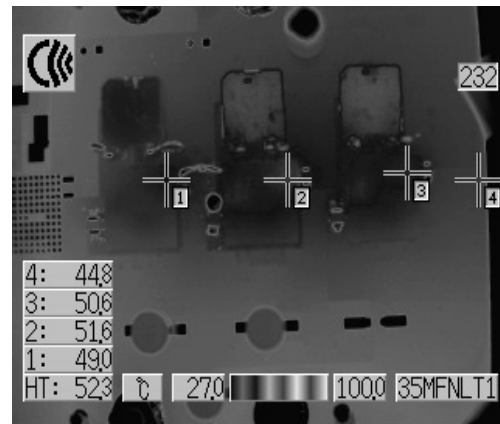

Figure 3b: Thermal capture at 12V_{IN}, 12V_{OUT}, 15A, 300kHz (DC1601A-B)
No Forced Airflow (Convection)

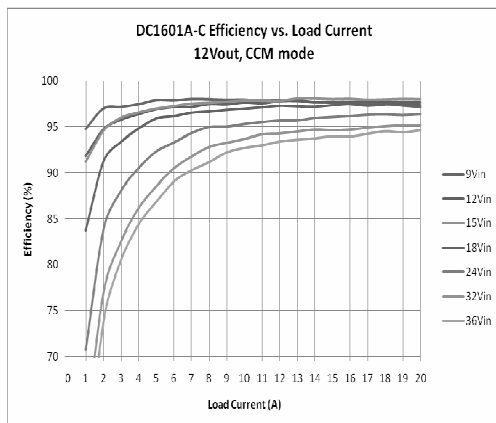

Figure 2c: Measured Efficiency at 12V_{OUT}, 300 kHz (DC1601A-C)

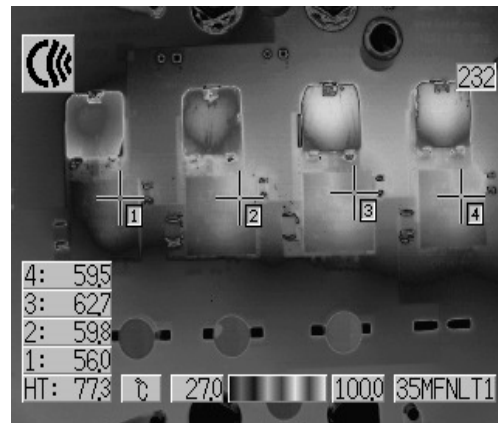

Figure 3c: Thermal capture at 32V_{IN}, 12V_{OUT}, 20A, 300kHz (DC1601A-C)
No Forced Airflow (Convection)

LTM4607EV

DC1601A-A: $V_{IN} = 9V$, $V_{OUT} = 12V$, $I_{OUTDC} = 5A$,
 $I_{OUT Step} = 5A$, $f_{SW} = 300\text{ kHz}$

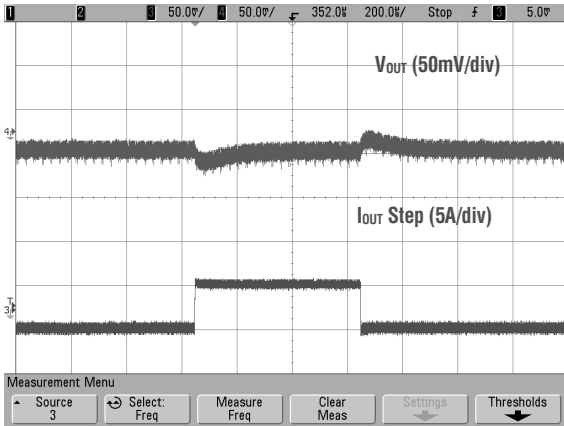

Figure 4a. Measured Load Step Response (DC1601A-A)

DC1601A-A: $V_{IN} = 9V$, $V_{OUT} = 12V$, $I_{OUT} = 10A$,
 $f_{SW} = 300\text{ kHz}$

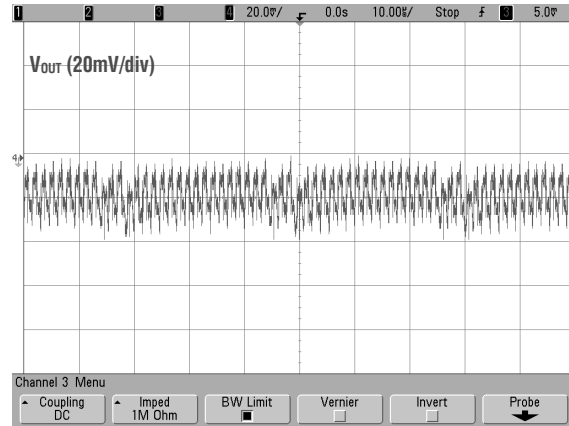

Figure 5a: Measured Output Voltage Ripple (DC1601A-A)

DC1601A-B: $V_{IN} = 12V$, $V_{OUT} = 12V$, $I_{OUTDC} = 7.5A$,
 $I_{OUT Step} = 7.5A$, $f_{SW} = 300\text{ kHz}$

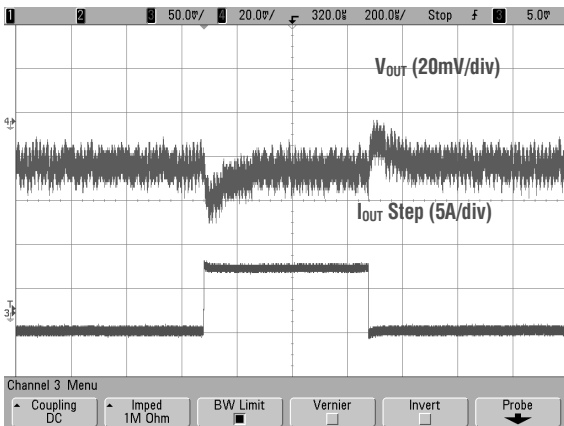

Figure 4b. Measured Load Step Response (DC1601A-B)

DC1601A-A: $V_{IN} = 12V$, $V_{OUT} = 12V$, $I_{OUT} = 15A$,
 $f_{SW} = 300\text{ kHz}$

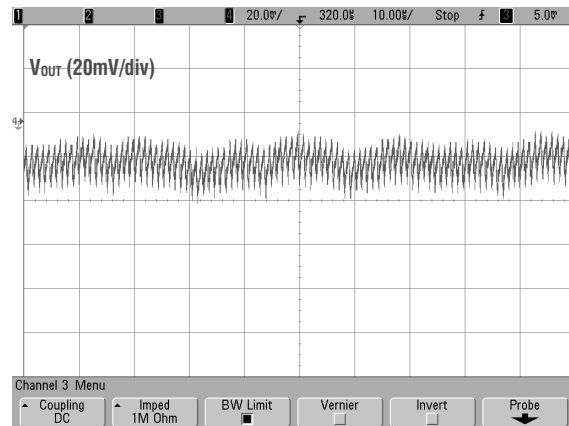

Figure 5b: Measured Output Voltage Ripple (DC1601A-B)

DC1601A-C: $V_{IN} = 32V$, $V_{OUT} = 12V$, $I_{OUTDC} = 10A$,
 $I_{OUT Step} = 7.5A$, $f_{SW} = 300\text{ kHz}$

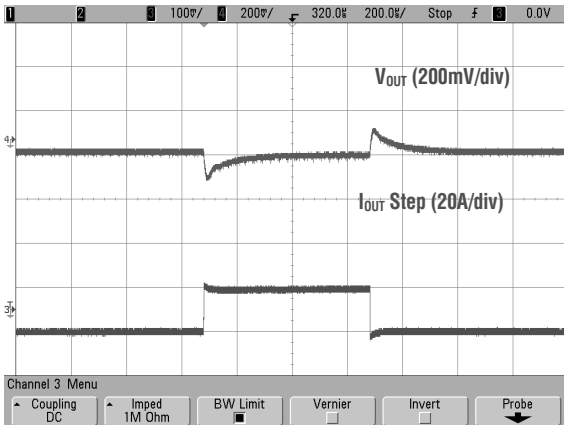

Figure 4c. Measured Load Step Response (DC1601A-C)

DC1601A-C: $V_{IN} = 32V$, $V_{OUT} = 12V$, $I_{OUT} = 20A$,
 $f_{SW} = 300\text{ kHz}$

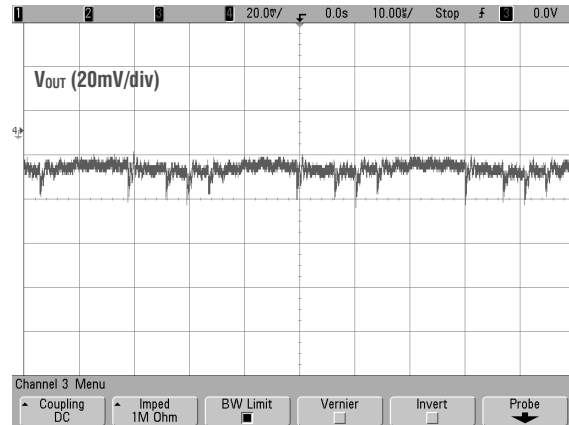
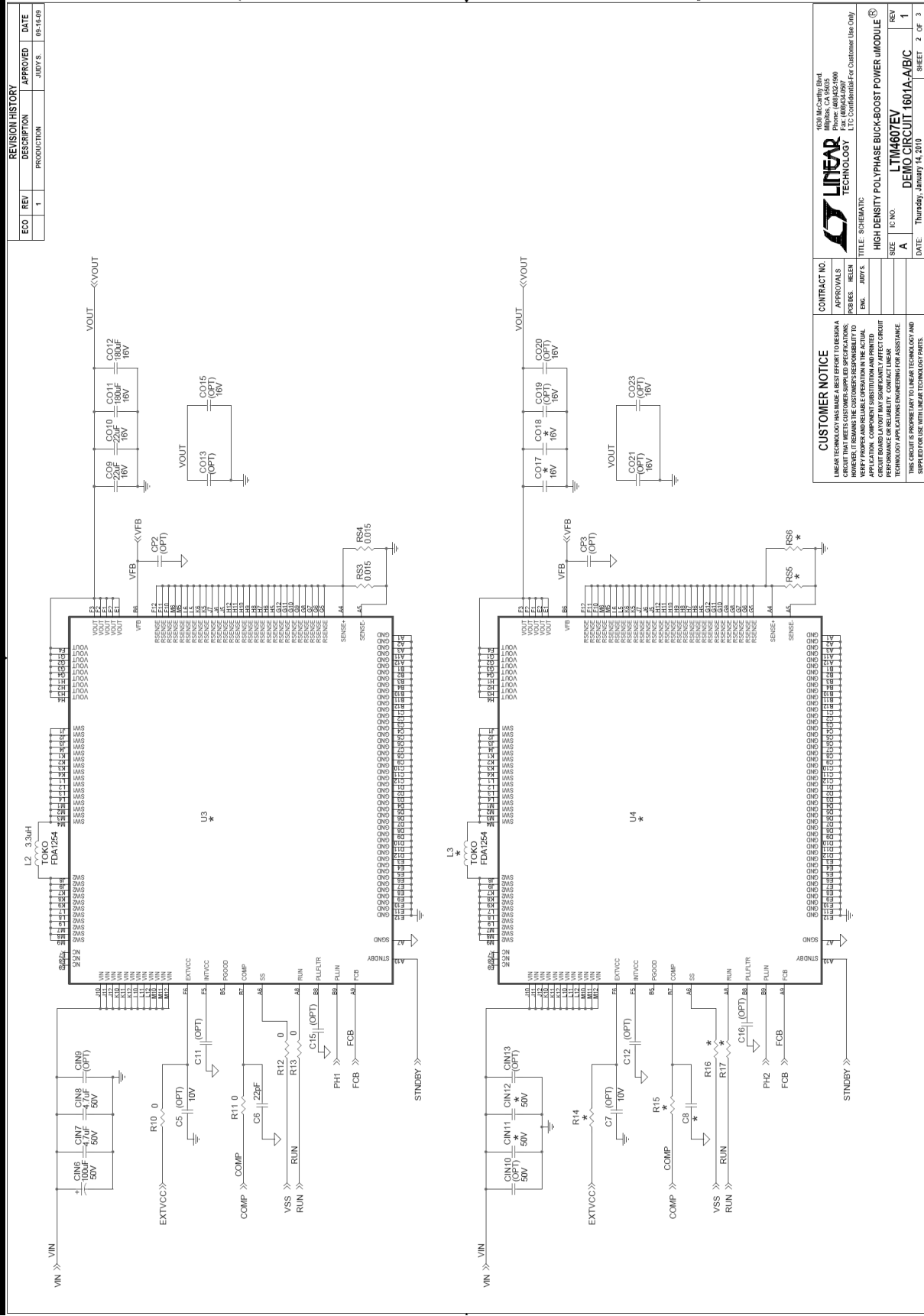

Figure 5c: Measured Output Voltage Ripple (DC1601A-C)

LTM4607EV



REVISION HISTORY			
ECO	REV	DESCRIPTION	APPROVED DATE
	1	PRODUCTION	JULY 05 06-16-09

CUSTOMER NOTICE	
APPROVALS	CONTRACT NO.
DESIGN	
TESTING	
PRODUCTION	
<p>LINEAR TECHNOLOGY</p> <p>1630 McCarthy Blvd. Folsom, CA 95630 Tel: 916/343-4900 Fax: 916/343-4997 LTC Confidential For Customer Use Only</p>	
<p>TITLE: SCHEMATIC</p> <p>SIZE: A</p> <p>DATE: Thursday, January 14, 2010</p>	
<p>DESCRIPTION: HIGH DENSITY POLYPHASE BUCK-BOOST POWER MODULE</p> <p>REV: 1</p> <p>ITEM NO: LTM4607EV</p> <p>DEMO CIRCUIT 1601A-ABC</p> <p>SHEET 2 OF 3</p>	

LTM4607EV

REVISION HISTORY			
ECO	REV	DESCRIPTION	APPROVED DATE
	1	PRODUCTION	JUDY S. 06-16-09

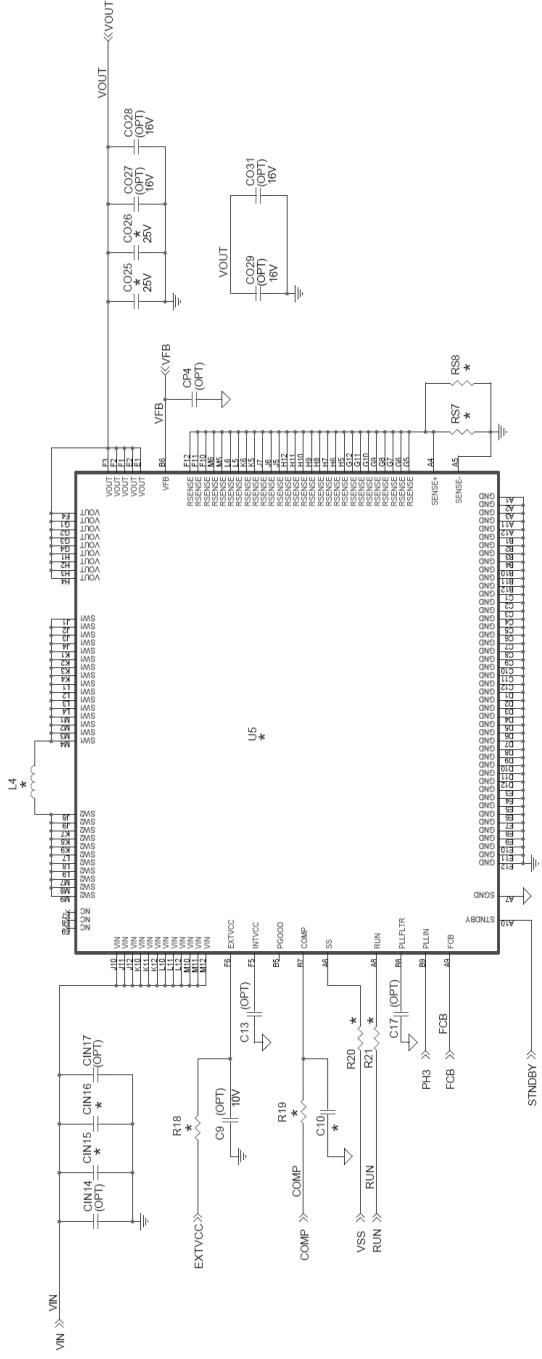

CUSTOMER NOTICE		CONTRACT NO.	
<p>THIS CIRCUIT IS A DEMO CIRCUIT. IT IS NOT DESIGNED TO MEET CUSTOMER SPECIFICATIONS. HOWEVER, IT REMAINS THE CUSTOMER'S RESPONSIBILITY TO VERIFY THE PERFORMANCE OF THE CIRCUIT. ANY CHANGES TO THE CIRCUIT BOARD LAYOUT MAY SIGNIFICANTLY AFFECT CIRCUIT PERFORMANCE OR RELIABILITY. CONTACT LINEAR TECHNOLOGY APPLICATIONS ENGINEERS FOR ASSISTANCE.</p>		APPROVALS	1639 McCarty Blvd.
		DESIGNER	Folsom, CA 95630
		DATE	TEL: 916.426.0000
			FAX: 916.426.4997
			WWW.LINEAR.COM
			LTC Confidential For Customer Use Only
TITLE: SCHEMATIC		SIZE	
HIGH DENSITY POLYPHASE BUCK-BOOST POWER MODULE		A	
LTM4607EV		REV	
DEMO CIRCUIT 1601A-A/B/C		1	
DATE: Thursday, January 14, 2010		SHEET 3 OF 3	