



### ACCESSORIES

### SOCKETS AND DIN RAIL TERMINAL SOCKET FOR HN RELAY

## TYPES

Type	No. of poles	Item	Part No.
PC board terminal socket	1-pole	HN1 PC board terminal socket	AHNA13
	2-pole	HN2 PC board terminal socket	AHNA23
DIN rail terminal socket	1-pole	HN1 DIN rail terminal socket	AHNA11K
	2-pole	HN2 DIN rail terminal socket	AHNA21K

Standard packing: Carton: 10 pcs.; Case: 100 pcs.

Note: Certified by UL/C-UL

## RATING

Item	Specifications			
	HN1 DIN rail terminal socket	HN1 PC board terminal socket	HN2 DIN rail terminal socket	HN2 PC board terminal socket
Type	1 Form C		2 Form C	
Contact arrangement	1 Form C		2 Form C	
Max. continuous current	10A		5A	
Dielectric strength (Initial)	Between open contacts	1,000 Vrms for 1 min. (Detection current: 10mA)		
	Between contact sets	3,000Vrms for 1 min. (Detection current: 10mA)		
	Between contact and coil	4,000Vrms for 1min. (Detection current: 10mA)	5,000Vrms for 1min. (Detection current: 10mA)	4,000Vrms for 1min. (Detection current: 10mA)
Insulation resistance (Initial)	1,000 MΩ between each terminal (500V DC)			
Conditions	Condisitons for usage, transport and strage Ambient temperature: -40 to 70°C, Humidity: 5 to 85% R.H. (Avoid icing when used at temperature lower than 0°C)			

## DIMENSIONS (mm) **CAD** The CAD data of the products with a "CAD" mark can be downloaded from our Website.

### 1. HN1 PC board terminal socket

(AHNA13)

**CAD**



External dimensions

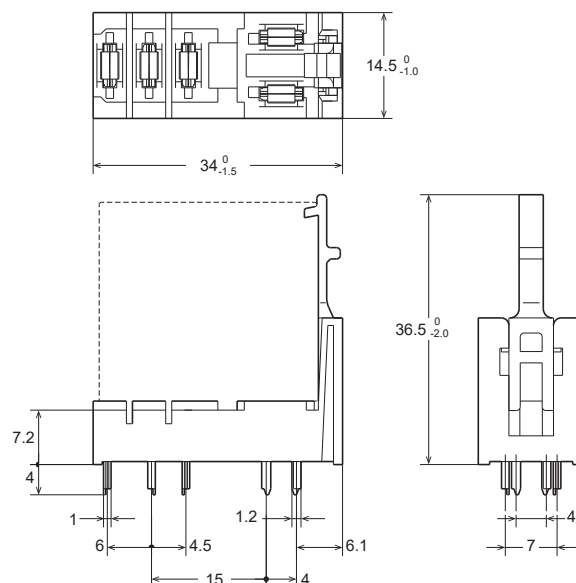

PC board pattern (Bottom view)

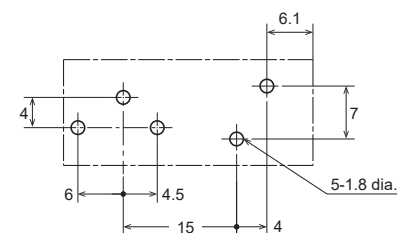

Dimension:	Tolerance
Less than 1mm:	±0.1
Min. 1mm less than 3mm:	±0.2
Min. 3mm:	±0.3

# HN (AHN) RELAY ACCESSORIES

## 2. HN2 PC board terminal socket

(AHNA23)

**CAD**

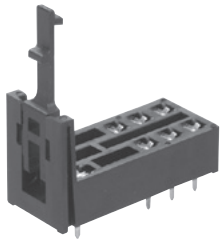

External dimensions

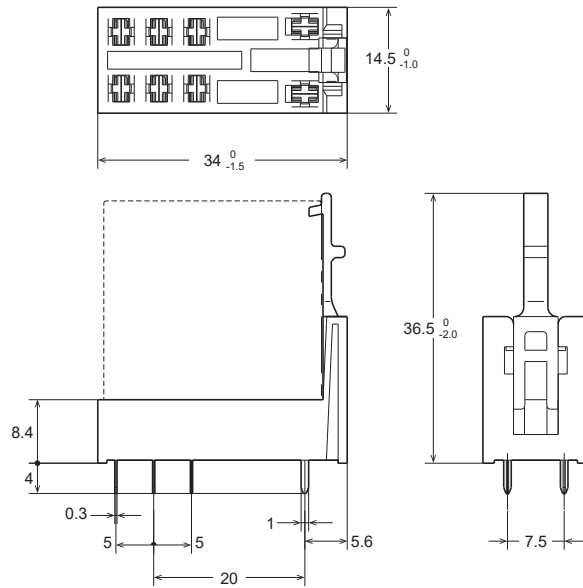

PC board pattern (Bottom view)

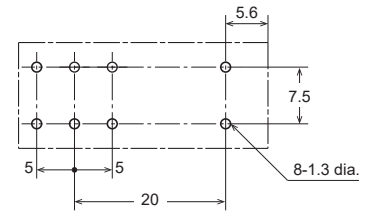

Tolerance:  $\pm 0.1$

Dimension:	Tolerance
Less than 1mm:	$\pm 0.1$
Min. 1mm less than 3mm:	$\pm 0.2$
Min. 3mm:	$\pm 0.3$

## 3. HN1 DIN rail terminal socket

(AHNA11K)

**CAD**



External dimensions

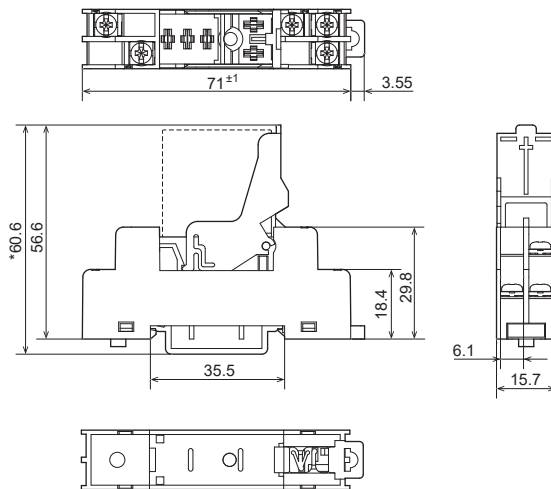

Schematic (Top view)

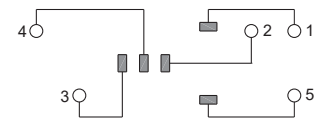

Mounting hole dimensions

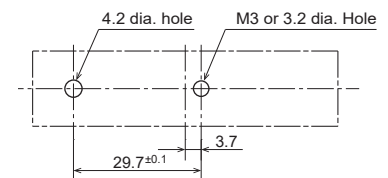

Tolerance:  $\pm 0.5$

\* Reference in case of using DIN rail (ATA48011)

- Notes: 1. In order to prevent damage or deformation, the tightening torque for the terminal socket should be within 0.3 N·m to 0.5 N·m.  
2. When attaching the terminal socket directly to a chassis, please use M3 screw and hex nut.

## 4.HN2 DIN rail terminal socket

(AHNA21K)

**CAD**

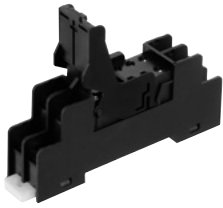

External dimensions

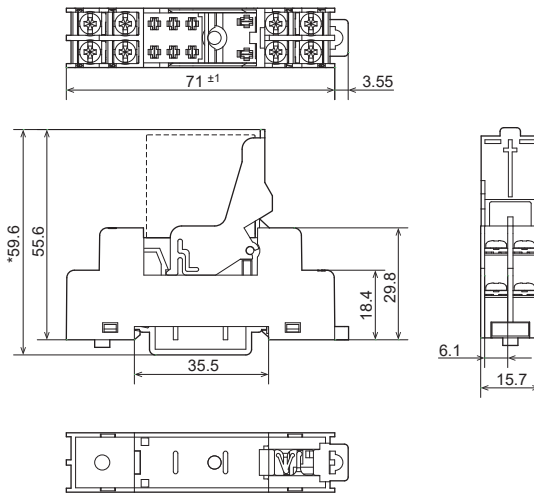

Schematic (Top view)

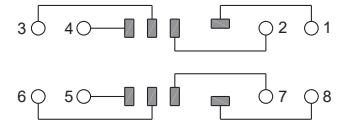

Mounting hole dimensions

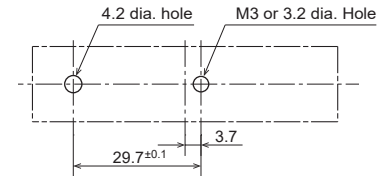

Tolerance:  $\pm 0.5$

\* Reference in case of using DIN rail (ATA48011)

Notes: 1. In order to prevent damage or deformation, the tightening torque for the terminal socket should be within 0.3 N·m to 0.5N·m.  
2. When attaching the terminal socket directly to a chassis, please use M3 screw and hex nut.

## NOTES

### Relay-securing hook

• DIN terminal socket

1) Firmly mount the relay to the bottom without gap and press hinge arm to the arrow direction and tighten the relay firmly with the securing hook.

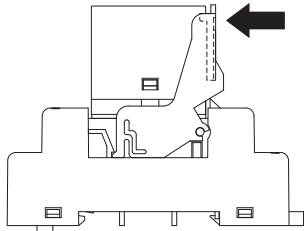

2) Release the securing hook completely to demount the relay, as shown in the figure.

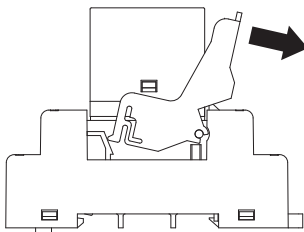

• PC board terminal socket

1) Installation of the securing hook is easily performed by pressing upward in the direction of the arrows.

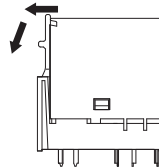

2) Removal of the securing hook is easily performed by releasing the hook and pressing down, as shown in the figure.

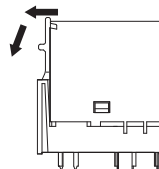

\* To prevent damage and deformity, please use the relay-securing hook at 10 N or less.

### Terminal connection method

• DIN terminal socket

1) In order to prevent damage or deformation, the tightening torque for the terminal socket should be specified as follows.

• M3: 0.49N·m to 0.69N·m

2) Use solderless terminals  
Refer to the below figure.

Spade tongue terminal

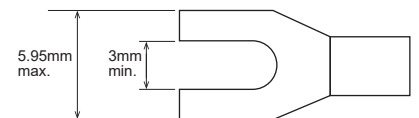

Ring tongue terminal

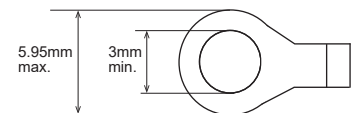

---

Please contact .....

**Panasonic Corporation**

Electromechanical Control Business Division

■ 1006, Oaza Kadoma, Kadoma-shi, Osaka 571-8506, Japan  
[industrial.panasonic.com/ac/e/](http://industrial.panasonic.com/ac/e/)

**Panasonic**<sup>®</sup>

©Panasonic Corporation 2019

---

ASCTB419E-1 201903

Specifications are subject to change without notice.