



FEATURES

- 1.5 Ω on resistance
- 0.28 Ω on-resistance flatness
- 0.1 Ω on-resistance match between channels
- Continuous current per channel up to 260 mA
- Fully specified at +12 V, ±15 V, and ±5 V
- No V_{SS} supply required
- 3 V logic-compatible inputs
- Rail-to-rail operation
- 16-lead TSSOP package

APPLICATIONS

- Automatic test equipment
- Data acquisition systems
- Battery-powered systems
- Sample-and-hold systems
- Audio signal routing
- Military communications
- Aviation

ENHANCED PRODUCT FEATURES

- Supports defense and aerospace applications (AQEC standard)
- Military temperature range (-55°C to +125°C)
- Controlled manufacturing baseline
- 1 assembly/test site
- 1 fabrication site
- Product change notification
- Qualification data available on request

GENERAL DESCRIPTION

The ADG1436-EP is a monolithic complementary metal-oxide semiconductor (CMOS) device containing two independently selectable SPDT switches. Each switch conducts equally well in both directions when on and has an input signal range that extends to the supplies. In the off condition, signal levels up to the supplies are blocked. Both switches exhibit break-before-make switching action for use in multiplexer applications.

The ADG1436-EP is designed on an iCMOS® process. iCMOS (industrial CMOS) is a modular manufacturing process combining high voltage CMOS and bipolar technologies. It enables the development of a wide range of high performance analog integrated circuits (ICs) capable of 33 V operation in a

FUNCTIONAL BLOCK DIAGRAM

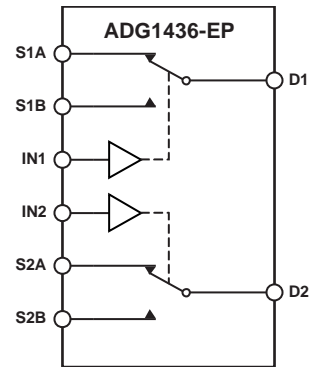

SWITCHES SHOWN FOR A ONE-INPUT LOGIC.

Figure 1.

17189-001

footprint that no previous generation of high voltage parts has been able to achieve. Unlike analog ICs using conventional CMOS processes, iCMOS components can tolerate high supply voltages while providing increased performance, dramatically lower power consumption, and reduced package size.

The on-resistance profile is very flat over the full analog input range, ensuring excellent linearity and low distortion when switching audio signals in military communication. iCMOS construction ensures ultralow power dissipation, making the part ideally suited for avionics and battery-powered instruments. Additional application and technical information can be found in the [ADG1436](#) data sheet.

Rev. 0

[Document Feedback](#)

Information furnished by Analog Devices is believed to be accurate and reliable. However, no responsibility is assumed by Analog Devices for its use, nor for any infringements of patents or other rights of third parties that may result from its use. Specifications subject to change without notice. No license is granted by implication or otherwise under any patent or patent rights of Analog Devices. Trademarks and registered trademarks are the property of their respective owners.

One Technology Way, P.O. Box 9106, Norwood, MA 02062-9106, U.S.A.
 Tel: 781.329.4700 ©2018 Analog Devices, Inc. All rights reserved.
[Technical Support](#) www.analog.com

TABLE OF CONTENTS

Features	1	5 V Dual Supply.....	5
Applications.....	1	Absolute Maximum Ratings	6
Enhanced Product Features	1	Thermal Resistance	6
Functional Block Diagram	1	ESD Caution.....	6
General Description	1	Pin Configurations and Function Descriptions	7
Revision History	2	Truth Table For Switches	7
Specifications.....	3	Typical Performance Characteristics	8
15 V Dual Supply.....	3	Outline Dimensions	10
12 V Single Supply.....	4	Ordering Guide	10

REVISION HISTORY

8/2018—Revision 0: Initial Version

SPECIFICATIONS

15 V DUAL SUPPLY

$V_{DD} = 15\text{ V} \pm 10\%$, $V_{SS} = -15\text{ V} \pm 10\%$, GND = 0 V, unless otherwise noted.

Table 1.

Parameter	25°C	-55°C to +125°C	Unit	Test Conditions/Comments
ANALOG SWITCH				
Analog Signal Range		V_{DD} to V_{SS}	V	
On Resistance, R_{ON}	1.5		Ω typ	$V_S = \pm 10\text{ V}$, $I_S = -10\text{ mA}$
	1.8	2.6	Ω max	$V_{DD} = +13.5\text{ V}$, $V_{SS} = -13.5\text{ V}$
On-Resistance Match Between Channels, ΔR_{ON}	0.1		Ω typ	$V_S = \pm 10\text{ V}$, $I_S = -10\text{ mA}$
	0.18	0.21	Ω max	
On-Resistance Flatness, $R_{FLAT(ON)}$	0.28		Ω typ	$V_S = \pm 10\text{ V}$, $I_S = -10\text{ mA}$
	0.36	0.45	Ω max	
Continuous Current Per Channel ¹	260	100	mA max	$V_{DD} = +13.5\text{ V}$, $V_{SS} = -13.5\text{ V}$
LEAKAGE CURRENTS				
Source Off Leakage, I_S (Off)	± 0.04		nA typ	$V_{DD} = +16.5\text{ V}$, $V_{SS} = -16.5\text{ V}$
	± 0.55	± 12.5	nA max	$V_S = \pm 10\text{ V}$, $V_D = \pm 10\text{ V}$
Drain Off Leakage, I_D (Off)	± 0.04		nA typ	$V_S = \pm 10\text{ V}$, $V_D = \pm 10\text{ V}$
	± 0.55	± 12.5	nA max	
Channel On Leakage, I_D , I_S (On)	± 0.1		nA typ	$V_S = V_D = \pm 10\text{ V}$
	± 2	± 35	nA max	
DIGITAL INPUTS				
Input High Voltage, V_{INH}		2.0	V min	
Input Low Voltage, V_{INL}		0.8	V max	
Input Current, I_{INL} or I_{INH}	0.005		μA typ	$V_{IN} = V_{GND}$ or V_{DD}
		± 0.1	μA max	
Digital Input Capacitance, C_{IN}	3.5		pF typ	
DYNAMIC CHARACTERISTICS¹				
Transition Time, $t_{TRANSITION}$	125		ns typ	$R_L = 300\ \Omega$, $C_L = 35\text{ pF}$
	170	245	ns max	$V_S = 10\text{ V}$
Break-Before-Make Time Delay, t_{BBM}	20		ns typ	$R_L = 300\ \Omega$, $C_L = 35\text{ pF}$
		10	ns min	$V_{S1} = V_{S2} = +10\text{ V}$
Charge Injection	-20		pC typ	$V_S = 0\text{ V}$, $R_S = 0\ \Omega$, $C_L = 1\text{ nF}$
Off Isolation	-80		dB typ	$R_L = 50\ \Omega$, $C_L = 5\text{ pF}$, $f = 100\text{ kHz}$
Channel-to-Channel Crosstalk	-80		dB typ	$R_L = 50\ \Omega$, $C_L = 5\text{ pF}$, $f = 100\text{ kHz}$
Total Harmonic Distortion + Noise	0.011		% typ	$R_L = 110\ \Omega$, 15 V p-p , $f = 20\text{ Hz to } 20\text{ kHz}$
-3 dB Bandwidth	110		MHz typ	$R_L = 50\ \Omega$, $C_L = 5\text{ pF}$
Insertion Loss	-0.18		dB typ	$R_L = 50\ \Omega$, $C_L = 5\text{ pF}$, $f = 1\text{ MHz}$
C_S (Off)	23		pF typ	$f = 1\text{ MHz}$, $V_S = 0\text{ V}$
C_D (Off)	50		pF typ	$f = 1\text{ MHz}$, $V_S = 0\text{ V}$
C_D , C_S (On)	120		pF typ	$f = 1\text{ MHz}$, $V_S = 0\text{ V}$
POWER REQUIREMENTS				
I_{DD}	0.001		μA typ	$V_{DD} = +16.5\text{ V}$, $V_{SS} = -16.5\text{ V}$
		1	μA max	Digital inputs = 0 V or V_{DD}
I_{DD}	170		μA typ	Digital input = 5 V
		285	μA max	
I_{SS}	0.001		μA typ	Digital inputs = 0 V, 5 V, or V_{DD}
		1.0	μA max	
V_{DD}/V_{SS}		$\pm 4.5/\pm 16.5$	V min/max	GND = 0 V

¹ Guaranteed by design, not subject to production test.

12 V SINGLE SUPPLY

$V_{DD} = 12\text{ V} \pm 10\%$, $V_{SS} = 0\text{ V}$, $GND = 0\text{ V}$, unless otherwise noted.

Table 2.

Parameter	25°C	-55°C to +125°C	Unit	Test Conditions/Comments
ANALOG SWITCH				
Analog Signal Range		0 V to V_{DD}	V	
On Resistance, R_{ON}	2.8		Ω typ	$V_S = 0\text{ V to }10\text{ V}$, $I_S = -10\text{ mA}$
	3.5	4.8	Ω max	$V_{DD} = 10.8\text{ V}$, $V_{SS} = 0\text{ V}$
On-Resistance Match Between Channels, ΔR_{ON}	0.13		Ω typ	$V_S = 0\text{ V to }10\text{ V}$, $I_S = -10\text{ mA}$
	0.21	0.25	Ω max	
On-Resistance Flatness, $R_{FLAT(ON)}$	0.6		Ω typ	$V_S = 0\text{ V to }10\text{ V}$, $I_S = -10\text{ mA}$
	1.1	1.3	Ω max	
Continuous Current Per Channel ¹	240	100	mA max	$V_{DD} = 10.8\text{ V}$, $V_{SS} = 0\text{ V}$
LEAKAGE CURRENTS				
Source Off Leakage, I_S (Off)	± 0.04		nA typ	$V_{DD} = 13.2\text{ V}$, $V_{SS} = 0\text{ V}$
	± 0.55	± 12.5	nA max	$V_S = 1\text{ V}/10\text{ V}$, $V_D = 10\text{ V}/1\text{ V}$
Drain Off Leakage, I_D (Off)	± 0.04		nA typ	$V_S = 1\text{ V}/10\text{ V}$, $V_D = 10\text{ V}/1\text{ V}$
	± 0.55	± 12.5	nA max	
Channel On Leakage, I_D , I_S (On)	± 0.1		nA typ	$V_S = V_D = 1\text{ V or }10\text{ V}$
	± 1	± 35	nA max	
DIGITAL INPUTS				
Input High Voltage, V_{INH}		2.0	V min	
Input Low Voltage, V_{INL}		0.8	V max	
Input Current, I_{INL} or I_{INH}	0.001		μA typ	$V_{IN} = V_{GND}$ or V_{DD}
		± 0.1	μA max	
Digital Input Capacitance, C_{IN}	3.5		pF typ	
DYNAMIC CHARACTERISTICS¹				
Transition Time, $t_{TRANSITION}$	200		ns typ	$R_L = 300\ \Omega$, $C_L = 35\text{ pF}$
	270	350	ns max	$V_S = 8\text{ V}$
Break-Before-Make Time Delay, t_{BBM}	70		ns typ	$R_L = 300\ \Omega$, $C_L = 35\text{ pF}$
		10	ns min	$V_{S1} = V_{S2} = 8\text{ V}$
Charge Injection	30		pC typ	$V_S = 6\text{ V}$, $R_S = 0\ \Omega$, $C_L = 1\text{ nF}$
Off Isolation	-80		dB typ	$R_L = 50\ \Omega$, $C_L = 5\text{ pF}$, $f = 100\text{ kHz}$
Channel-to-Channel Crosstalk	-80		dB typ	$R_L = 50\ \Omega$, $C_L = 5\text{ pF}$, $f = 100\text{ kHz}$
-3 dB Bandwidth	78		MHz typ	$R_L = 50\ \Omega$, $C_L = 5\text{ pF}$
Insertion Loss	-0.3		dB typ	$R_L = 50\ \Omega$, $C_L = 5\text{ pF}$, $f = 1\text{ MHz}$
C_S (Off)	40		pF typ	$f = 1\text{ MHz}$, $V_S = 6\text{ V}$
C_D (Off)	80		pF typ	$f = 1\text{ MHz}$, $V_S = 6\text{ V}$
C_D , C_S (On)	140		pF typ	$f = 1\text{ MHz}$, $V_S = 6\text{ V}$
POWER REQUIREMENTS				
I_{DD}	0.001		μA typ	$V_{DD} = 13.2\text{ V}$
		1.0	μA max	Digital inputs = 0 V or V_{DD}
I_{DD}	170		μA typ	Digital inputs = 5 V
		285	μA max	
V_{DD}		5/16.5	V min/max	$GND = 0\text{ V}$, $V_{SS} = 0\text{ V}$

¹ Guaranteed by design, not subject to production test.

5 V DUAL SUPPLY

$V_{DD} = 5\text{ V} \pm 10\%$, $V_{SS} = -5\text{ V} \pm 10\%$, $GND = 0\text{ V}$, unless otherwise noted.

Table 3.

Parameter	25°C	-55°C to +125°C	Unit	Test Conditions/Comments
ANALOG SWITCH				
Analog Signal Range		V_{DD} to V_{SS}	V	
On Resistance, R_{ON}	3.3		Ω typ	$V_S = \pm 4.5\text{ V}$, $I_S = -10\text{ mA}$
	4	5.4	Ω max	$V_{DD} = +4.5\text{ V}$, $V_{SS} = -4.5\text{ V}$
On-Resistance Match Between Channels, ΔR_{ON}	0.13		Ω typ	$V_S = \pm 4.5\text{ V}$, $I_S = -10\text{ mA}$
	0.22	0.25	Ω max	
On-Resistance Flatness, $R_{FLAT(ON)}$	0.9		Ω typ	$V_S = \pm 4.5\text{ V}$, $I_S = -10\text{ mA}$
	1.1	1.31	Ω max	
Continuous Current Per Channel ¹	240	100	mA max	$V_{DD} = +4.5\text{ V}$, $V_{SS} = -4.5\text{ V}$
LEAKAGE CURRENTS				
Source Off Leakage, I_S (Off)	± 0.03		nA typ	$V_{DD} = +5.5\text{ V}$, $V_{SS} = -5.5\text{ V}$
	± 0.2	± 12.5	nA max	$V_S = \pm 4.5\text{ V}$, $V_D = \mp 4.5\text{ V}$
Drain Off Leakage, I_D (Off)	± 0.03		nA typ	$V_S = \pm 4.5\text{ V}$, $V_D = \mp 4.5\text{ V}$
	± 0.2	± 12.5	nA max	
Channel On Leakage, I_D , I_S (On)	± 0.05		nA typ	$V_S = V_D = \pm 4.5\text{ V}$
	± 0.25	± 35	nA max	
DIGITAL INPUTS				
Input High Voltage, V_{INH}		2.0	V min	
Input Low Voltage, V_{INL}		0.8	V max	
Input Current, I_{INL} or I_{INH}	0.001		μA typ	$V_{IN} = V_{GND}$ or V_{DD}
		± 0.1	μA max	
Digital Input Capacitance, C_{IN}	3.5		pF typ	
DYNAMIC CHARACTERISTICS¹				
Transition Time, $t_{TRANSITION}$	310		ns typ	$R_L = 300\ \Omega$, $C_L = 35\text{ pF}$
	445	565	ns max	$V_S = 3\text{ V}$
Break-Before-Make Time Delay, t_{BBM}	80		ns typ	$R_L = 300\ \Omega$, $C_L = 35\text{ pF}$
		10	ns min	$V_{S1} = V_{S2} = 3\text{ V}$
Charge Injection	30		pC typ	$V_S = 0\text{ V}$, $R_S = 0\ \Omega$, $C_L = 1\text{ nF}$
Off Isolation	-80		dB typ	$R_L = 50\ \Omega$, $C_L = 5\text{ pF}$, $f = 100\text{ kHz}$
Channel-to-Channel Crosstalk	-80		dB typ	$R_L = 50\ \Omega$, $C_L = 5\text{ pF}$, $f = 100\text{ kHz}$
Total Harmonic Distortion + Noise	0.03		% typ	$R_L = 110\ \Omega$, 2.5 V pp , $f = 20\text{ Hz to } 20\text{ kHz}$
-3 dB Bandwidth	85		MHz typ	$R_L = 50\ \Omega$, $C_L = 5\text{ pF}$
Insertion Loss	-0.28		dB typ	$R_L = 50\ \Omega$, $C_L = 5\text{ pF}$, $f = 1\text{ MHz}$
C_S (Off)	33		pF typ	$V_S = 0\text{ V}$, $f = 1\text{ MHz}$
C_D (Off)	65		pF typ	$V_S = 0\text{ V}$, $f = 1\text{ MHz}$
C_D , C_S (On)	145		pF typ	$V_S = 0\text{ V}$, $f = 1\text{ MHz}$
POWER REQUIREMENTS				
I_{DD}	0.001		μA typ	$V_{DD} = +5.5\text{ V}$, $V_{SS} = -5.5\text{ V}$
		1.0	μA max	Digital inputs = 0 V or V_{DD}
I_{SS}	0.001		μA typ	Digital inputs = 0 V or V_{DD}
		1.0	μA max	
V_{DD}/V_{SS}		$\pm 4.5/\pm 16.5$	V min/max	$GND = 0\text{ V}$

¹ Guaranteed by design, not subject to production test.

ABSOLUTE MAXIMUM RATINGS

T_A = 25°C, unless otherwise noted.

Table 4.

Parameter	Ratings
V _{DD} to V _{SS}	35 V
V _{DD} to GND	-0.3 V to +25 V
V _{SS} to GND	+0.3 V to -25 V
Analog Inputs ¹	V _{SS} - 0.3 V to V _{DD} + 0.3 V or 30 mA, whichever occurs first
Digital Inputs ¹	GND - 0.3 V to V _{DD} + 0.3 V or 30 mA, whichever occurs first
Peak Current, S or D	600 mA (pulsed at 1 ms, 10% duty cycle maximum)
Continuous Power Dissipation ²	See Figure 2
Operating Temperature Range	-55°C to +125°C
Storage Temperature Range	-65°C to +150°C
Junction Temperature	150°C
Reflow Soldering Peak Temperature, Pb-Free	260(+0/-5)°C

¹ Overvoltages at IN, S, and D are clamped by internal diodes. Current must be limited to the maximum ratings given.

² Calculated based on Table 3 model.

Stresses at or above those listed under Absolute Maximum Ratings may cause permanent damage to the product. This is a stress rating only; functional operation of the product at these or any other conditions above those indicated in the operational section of this specification is not implied. Operation beyond the maximum operating conditions for extended periods may affect product reliability.

THERMAL RESISTANCE

Thermal performance is directly linked to printed circuit board (PCB) design and operating environment. Careful attention to PCB thermal design is required.

θ_{JA} is the natural convection junction to ambient thermal resistance measured in a one cubic foot sealed enclosure.

Table 5. Thermal Resistance

Package Type ¹	θ _{JA}	Unit
RU-16	112	°C/W

¹ Thermal impedance simulated values are based on a JEDEC 252P thermal test board. See JEDEC JESD-51.

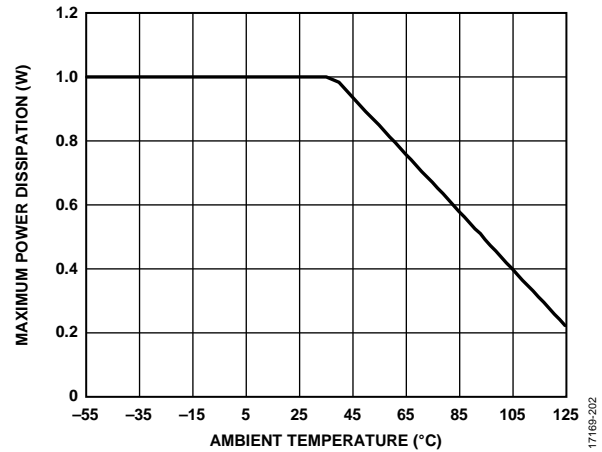

Figure 2. Maximum Power Dissipation vs. Ambient Temperature

ESD CAUTION



ESD (electrostatic discharge) sensitive device. Charged devices and circuit boards can discharge without detection. Although this product features patented or proprietary protection circuitry, damage may occur on devices subjected to high energy ESD. Therefore, proper ESD precautions should be taken to avoid performance degradation or loss of functionality.

PIN CONFIGURATIONS AND FUNCTION DESCRIPTIONS

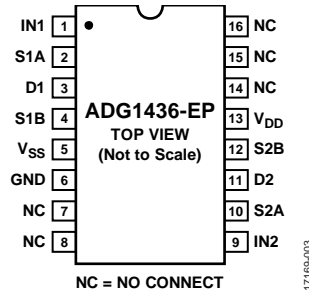

Figure 3. Pin Configuration

Table 6. Pin Function Descriptions

Pin No.	Mnemonic	Function
1	IN1	Logic Control Input.
2	S1A	Source Terminal. Can be an input or output.
3	D1	Drain Terminal. Can be an input or output.
4	S1B	Source Terminal. Can be an input or output.
5	V _{SS}	Most Negative Power Supply Potential.
6	GND	Ground (0 V) Reference.
7, 8, 14 to 16	NC	No Connect.
9	IN2	Logic Control Input.
10	S2A	Source Terminal. Can be an input or output.
11	D2	Drain Terminal. Can be an input or output.
12	S2B	Source Terminal. Can be an input or output.
13	V _{DD}	Most Positive Power Supply Potential.

TRUTH TABLE FOR SWITCHES

Table 7. Truth Table

IN _x	S _x A	S _x B
0	Off	On
1	On	Off

TYPICAL PERFORMANCE CHARACTERISTICS

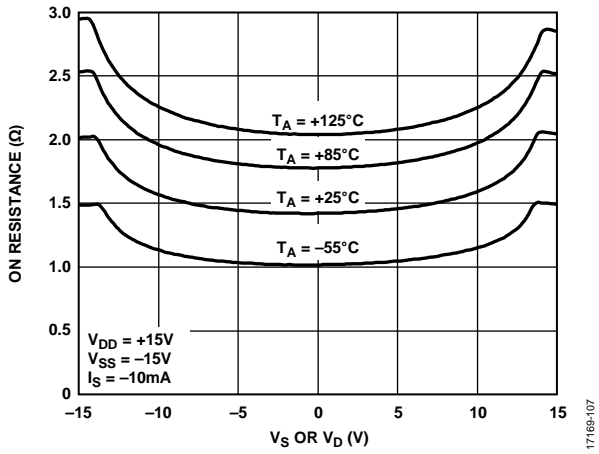

Figure 4. On Resistance vs. V_S or V_D for Different Temperatures, 15 V Dual Supply

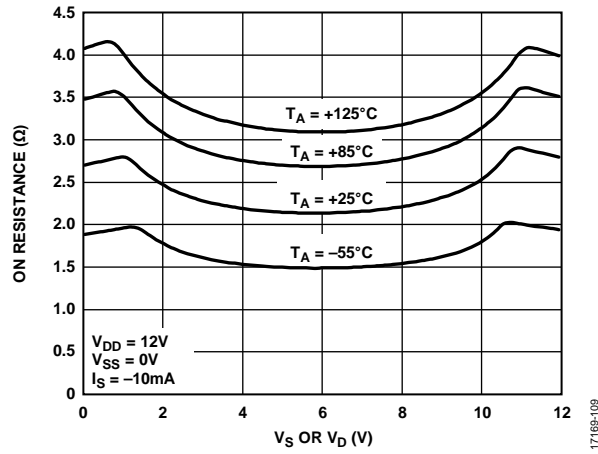

Figure 6. On Resistance vs. V_S or V_D for Different Temperatures, Single Supply

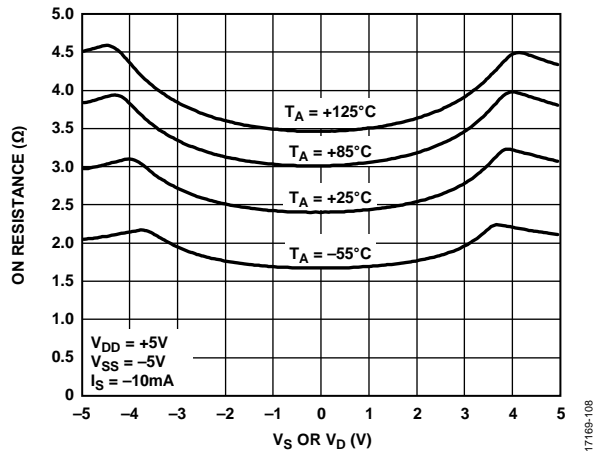

Figure 5. On Resistance vs. V_S or V_D for Different Temperatures, 5 V Dual Supply

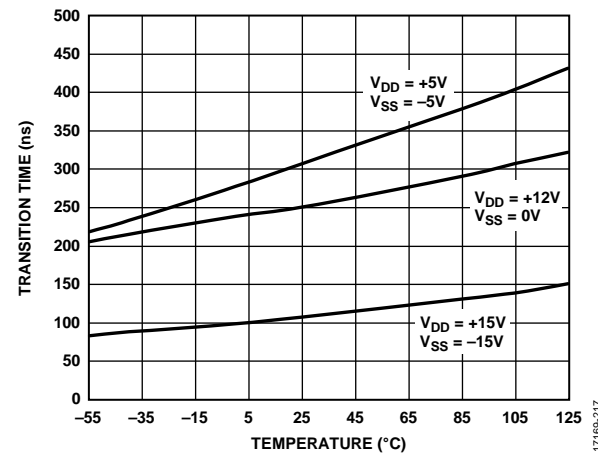

Figure 7. Transition Time vs. Temperature

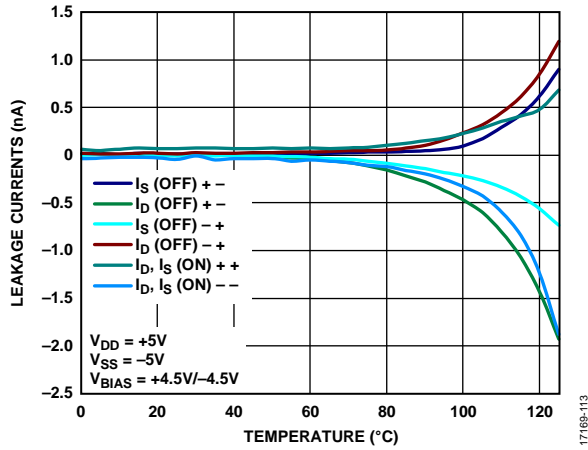

Figure 8. Leakage Currents vs. Temperature, 5 V Dual Supply

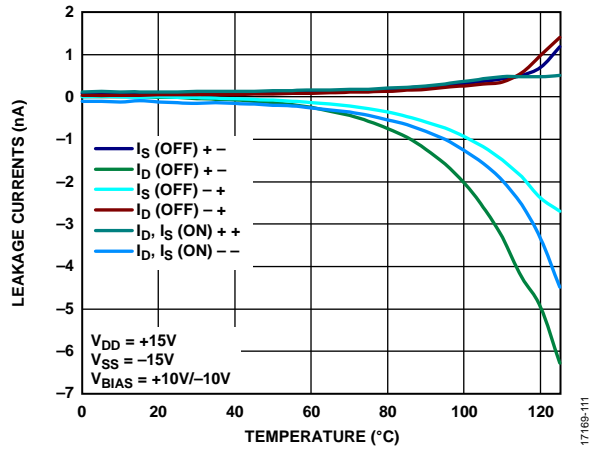

Figure 10. Leakage Currents vs. Temperature, 15 V Dual Supply

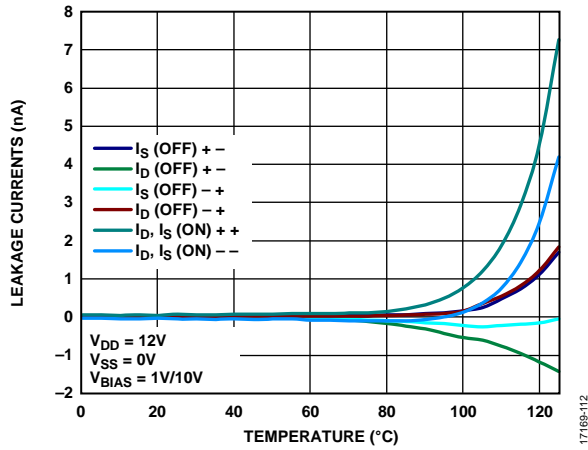
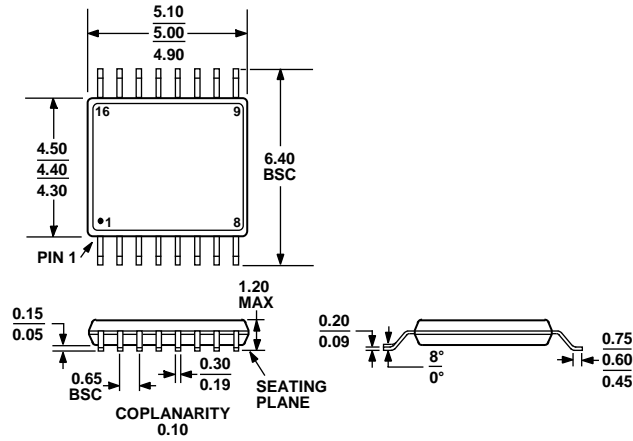

Figure 9. Leakage Currents vs. Temperature, 12 V Single Supply

OUTLINE DIMENSIONS



COMPLIANT TO JEDEC STANDARDS MO-153-AB

Figure 11. 16-Lead Thin Shrink Small Outline Package [TSSOP] (RU-16)

Dimensions shown in millimeters

ORDERING GUIDE

Model ¹	Temperature Range	Package Description	Package Option
ADG1436TRUZ-EP	-55°C to +125°C	16-Lead Thin Shrink Small Outline Package [TSSOP]	RU-16
ADG1436TRUZ-EPR7	-55°C to +125°C	16-Lead Thin Shrink Small Outline Package [TSSOP]	RU-16

¹ Z = RoHS Compliant Part.