

Chip Varistors

Countermeasure for surge voltage and static electricity

AVR series

Type: **AVR-M**
 AVRL

Issue date: September 2013

- All specifications are subject to change without notice.
- Conformity to RoHS Directive: This means that, in conformity with EU Directive 2002/95/EC, lead, cadmium, mercury, hexavalent chromium, and specific bromine-based flame retardants, PBB and PBDE, have not been used, except for exempted applications.

Varistors(SMD)

Countermeasure for Surge Voltage and Static Electricity

AVR Series AVR-M, AVRL Types

Varistors are voltage dependent nonlinear resistive elements with a resistance that decreases rapidly when the voltage is over the constant value.

Varistor is equivalent with Zener diode of two series connection. Therefore, do not have polarity.

CURRENT vs. VOLTAGE CHARACTERISTICS

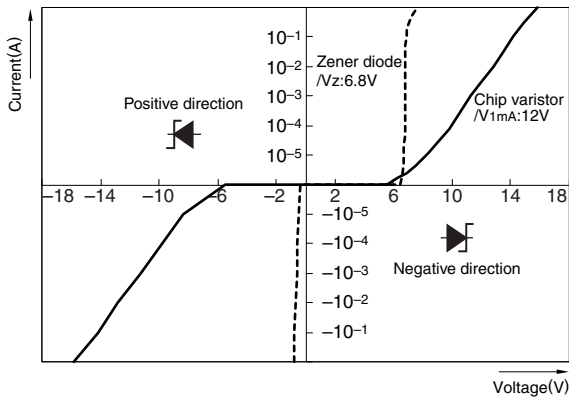

EQUIVALENT CIRCUIT

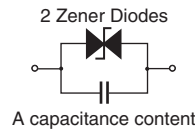

THE EFFECT OF THE VARISTOR WITHOUT VARISTOR

A malfunction and failure of electronic equipment

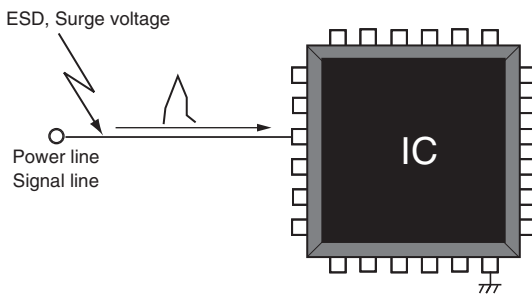

WITH VARISTOR

Suppress abnormal voltage by inserting varistor in a circuit

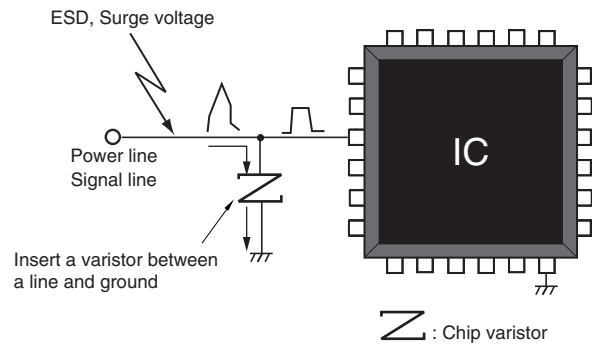

• All specifications are subject to change without notice.

FEATURES

- No polarity, due to symmetrical current-voltage characteristics. Equivalent to anode common type Zener diode.
- Excellent electrostatic absorption capability. Response is as good or better than Zener diode. Keeps symmetrical current-voltage characteristics even after electrostatic absorption.
- Adopted the inner electrodes lamination structure. Wide range of varistor voltages are available in series (6.8 to 39V). Low capacitance items are available in series (1.1pF to). World's smallest 0402-, 0603-, 1005-, 1608-, 2012-chip types are available in series.
- Excellent mount reliability. Good for Pb-free soldering. Adopted (Ni/Sn) electroplating. Achieved good solderability and solder heat resistance.
- Can replace a Zener diode + capacitor combination. Reduced footprint and total mounting cost.

APPLICATIONS

- Electrostatic absorption
- Pulse noise absorption

TEMPERATURE RANGES

Type	AVR-M1005/1608/2012	AVR-M0402/0603/AVRL
Operating	-40 to +125°C	-40 to +85°C
Storage	-40 to +125°C	-40 to +85°C

APPLICATION EXAMPLES

Consumer product	Application
Mobile phone	Data terminal
Digital video camera	LCD panel
Digital camera	Touch panel
PDA	Button and switch unit
Note PC	Battery terminal
DVD-ROM, CD-ROM	Audio-Video input-output terminal
CD/MD/MP3 player	Microphone/receiver unit
Game machine	Controller unit
	CAN-BUS
	ECU
In-car equipment	Connector
	Air conditioner panel
	Car audio
	Car navigation

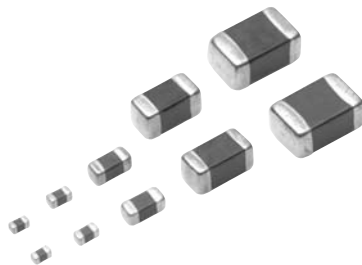

INTERNAL STRUCTURE

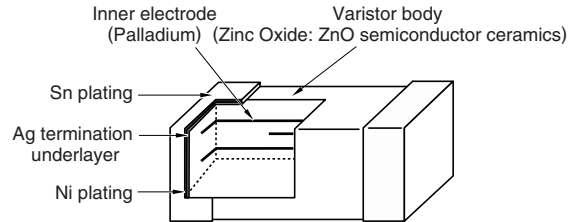

CIRCUITS SYMBOL

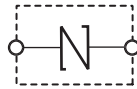

OPERATIONAL VOLTAGE RANGES

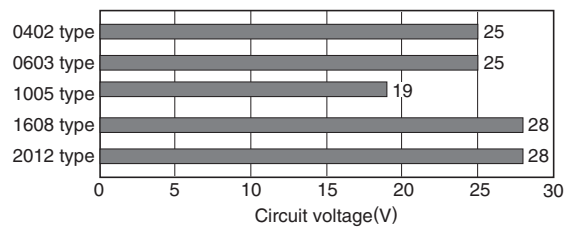

RECOMMENDED REFLOW SOLDERING CONDITIONS

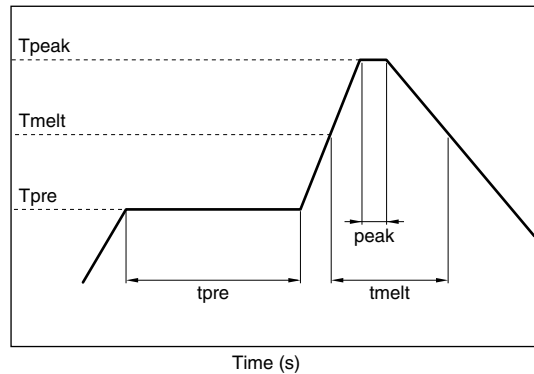

Item	Specification	Specification	
		For eutectic solder	For lead-free solder
Tpre	Preheating temperature	160 to 180°C	150 to 180°C
Tmelt	Solder melting temperature	200°C	230°C
Tpeak	Peak temperature	240°C max.	260°C max.
tpre	Preheating time	100s max.	120s max.
tmelt	Time to reach higher than the solder melting temperature	30s max.	40s max.
	Number of possible reflow cycles	2 max.	2 max.

• All specifications are subject to change without notice.

AVR-M TYPE**PRODUCT IDENTIFICATION**

AVR-M	1005	C	270	M	T	AAB
(1)	(2)	(3)	(4)	(5)	(6)	(7)

AVRM	1005	C	6R8	N	T	101	N
(1)	(2)	(3)	(4)	(5)	(6)	(7)	(8)

(1) Series name

(2) Dimensions L×W

0402	0.4×0.2mm
0603	0.6×0.3mm
1005	1.0×0.5mm
1608	1.6×0.8mm
2012	2.0×1.2mm

(3) Structure code

(4) Varistor voltage

270	27×10 ⁰ V
-----	----------------------

(5) Varistor voltage tolerance

K	±10%
M	±20%
N	±30%

(6) Packaging style

T	Taping
---	--------

(7) Capacitance and TDK internal code

(5) Capacitance tolerance

N	±30%
---	------

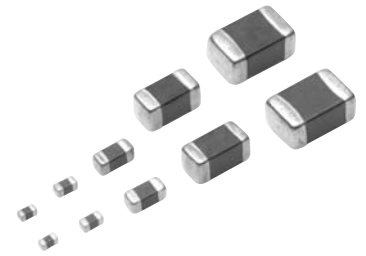
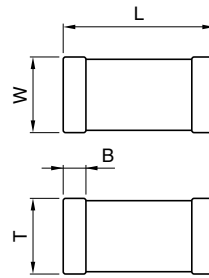
SHAPES AND DIMENSIONS**0402/0603/1005/1608/2012 TYPES**

Dimensions in mm

Type	L	W	T	B min.	Weight (mg)typ.
0402	0.4±0.02	0.2±0.02	0.2±0.02	0.07	0.1
0603	0.6±0.03	0.3±0.03	0.3±0.03	0.1	0.2
1005	1.0±0.05	0.5±0.05	0.5±0.05	0.1	1.2
1608	1.6±0.1	0.8±0.1	0.8±0.1	0.2	5
2012	2.0±0.2	1.25±0.2	1.0±0.2	0.2	15

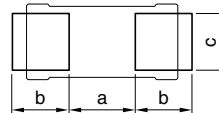
RECOMMENDED PC BOARD PATTERN

Dimensions in mm

Type	a	b	c
0402	0.2	0.15 to 0.2	0.18 to 0.2
0603	0.25 to 0.35	0.2 to 0.3	0.25 to 0.35
1005	0.3 to 0.5	0.35 to 0.45	0.4 to 0.6
1608	0.6 to 0.8	0.6 to 0.8	0.6 to 0.8
2012	0.9 to 1.2	0.7 to 0.9	0.9 to 1.2

ELECTRICAL CHARACTERISTICS

Part No.	Varistor voltage (Breakdown voltage) V _{1mA} (V)[DC1mA]		Maximum continuous voltage (Rated voltage) V _{dc} (V) max.	Clamping voltage V _{cl} (V) [8/20μs]	Maximum energy E(Joule) [10/1000μs] max.	Maximum peak current I _p (A) [8/20μs] max.	Capacitance C(pF) [1kHz, 1V _{rms}] typ.	Packaging quantities (Taping) (pieces/reel)
0402 type								
AVRM0402C6R8NT101N	6.8	(4.76 to 8.84)	3.5	15[1A]	0.01	4	100 (70 to 130)	20,000
AVRM0402C120MT330N	12	(9.6 to 14.4)	5.5	20[1A]	0.005	1	33 (23.1 to 43.9)	
0603 type								
AVRM0603C6R8NT331N	6.8	(4.76 to 8.84)	3.5	14[1A]	0.02	16	330 (231 to 429)	15,000
AVRM0603C6R8NT101N	6.8	(4.76 to 8.84)	3.5	14[1A]	0.01	10	100 (70 to 130)	
AVRM0603C080MT101N	8	(6.4 to 9.6)	5.5	17[1A]	0.01	4	100 (70 to 130)	
AVRM0603C120MT101N	12.8	(10 to 15.6)	5.5	20[1A]	0.01	5	100 (70 to 130)	
AVR-M0603C120MTAAB	12	(9.6 to 14.4)	7.5	23[1A]	0.01	1	33	
AVRM0603C120MT150N	12.8	(10 to 15.6)	5.5	35[1A]	0.003	1	15 (10.5 to 19.5)	
AVRM0603C200MT150N	20	(16.0 to 24.0)	12	40[1A]	0.01	1	15 (10.5 to 19.5) [1MHz]	
1005 type								
AVRM1005C6R8NT331N	6.8	(4.76 to 8.84)	3.5	15[1A]	0.008	24	330 (231 to 429)	10,000
AVRM1005C6R8NT101N	6.8	(4.76 to 8.84)	3.5	14[1A]	0.02	10	100 (70 to 130)	
AVR-M1005C080MTAAB	8	(6.4 to 9.6)	5.5	14[1A]	0.04	25	650	
AVR-M1005C080MTADB	8	(6.4 to 9.6)	5.5	14[1A]	0.04	25	480	
AVR-M1005C080MTABB	8	(6.4 to 9.6)	5.5	15[1A]	0.02	3	100	
AVR-M1005C080MTACB	8	(6.4 to 9.6)	5.5	19[1A]	0.01	1	33	
AVR-M1005C120MTACC	12	(9.6 to 14.4)	7.5	21[1A]	0.01	24	460 [1MHz]	
AVR-M1005C120MTAAB	12	(9.6 to 14.4)	7.5	20[1A]	0.05	10	130	
AVR-M1005C180MTAAB	18	(14.4 to 21.6)	11	30[1A]	0.06	16	120 [1MHz]	
AVRM1005C270KT101N	27	(24 to 30)	19	44[1A]	0.06	4	100 (70 to 130)	
AVR-M1005C270MTAAB	27	(21.6 to 32.4)	15	47[1A]	0.06	4	40	
AVR-M1005C270MTABB	27	(21.6 to 32.4)	15	49[1A]	0.05	1	15	
1608 type								
AVR-M1608C080MTAAB	8	(6.4 to 9.6)	5.5	15[2A]	0.09	30	650	4,000
AVR-M1608C120MT6AB	12	(9.6 to 14.4)	7.5	20[2A]	0.09	50	1050	
AVR-M1608C120MT2AB	12	(9.6 to 14.4)	7.5	20[2A]	0.06	15	400	
AVR-M1608C180MT6AB	18	(14.4 to 21.6)	11	30[2A]	0.1	30	600	
AVR-M1608C220KT6AB	22	(19.8 to 24.2)	16	34[2A]	0.1	30	560	
AVR-M1608C220KT2AB	22	(19.8 to 24.2)	16	37[2A]	0.03	10	210	
AVR-M1608C270KT6AB	27	(24 to 30)	19	42[2A]	0.1	48	430	
AVR-M1608C270KT2AB	27	(24 to 30)	19	42[2A]	0.1	20	160	
AVR-M1608C270KTACB	27	(24 to 30)	19	54[2A]	0.05	10	60	
AVRM1608C270KT800M	27	(24 to 30)	19	53[2A]	0.02	28	80 (64 to 96)	
AVR-M1608C270MTAAB	27	(21.6 to 32.4)	17	52[2A]	0.05	2	30	
AVR-M1608C270MTABB	27	(21.6 to 32.4)	17	52[2A]	0.05	2	15	
AVRM1608C390KT271N	39	(35 to 43)	28	69[2A]	0.1	78	270 (189 to 351)	
2012 type								
AVR-M2012C120MT6AB	12	(9.6 to 14.4)	7.5	20[5A]	0.2	60	1000	2,000
AVR-M2012C220KT6AB	22	(19.8 to 24.2)	16	38[5A]	0.3	100	800	
AVR-M2012C390KT6AB	39	(35 to 43)	28	62[5A]	0.3	100	430	

TERMINOLOGY

Item	Unit	Terminology
Varistor voltage (Breakdown voltage)	V _{1mA} (V)	Voltage measured across the varistor when DC1mA is applied.
Maximum continuous voltage (Rated voltage)	V _{dc} (V)	Maximum DC voltage that can be applied continuously. Varistor leakage current: 50μA max. (Within the range of maximum allowable circuit voltage)
Clamping voltage	V _{cl} (V)	Voltage appearing across the varistor when a pulse current (8/20μs*) of specified peak value is applied.
Maximum energy	E (Joule)	Maximum energy that can be absorbed without deteriorating varistor characteristics when an impulse (10/1000μs*) is applied once.
Maximum peak current	I _p (A)	Maximum current that can be withstood without deteriorating varistor characteristics when an impulse current (8/20μs*) is applied once.
Capacitance	C (pF)	Capacitance measured at 1kHz (or 1MHz) of oscillator frequency and 1V _{rms} of oscillator voltage.

*1 8/20μs test waveform

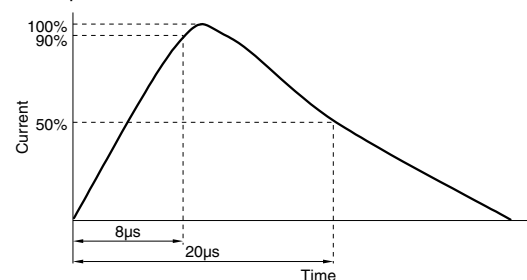

*2 10/1000μs test waveform

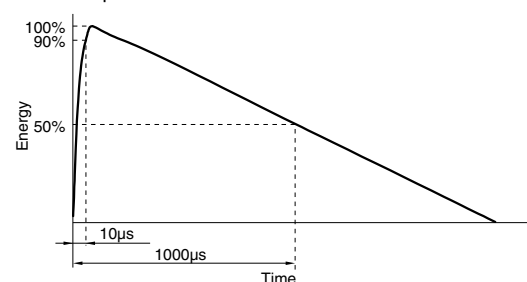

• All specifications are subject to change without notice.

AVRL TYPE

PRODUCT IDENTIFICATION

AVRL	10	1A	3R3	F	T	A
(1)	(2)	(3)	(4)	(5)	(6)	(7)

(1) Series name

(2) Dimensions L×W

04	0.4×0.2mm
06	0.6×0.3mm
10	1.0×0.5mm
16	1.6×0.8mm

(3) Maximum continuous voltage

1A	10Vdc
1C	16Vdc
1E	25Vdc

(4) Capacitance

1R1	1.1pF
2R2	2.2pF
3R3	3.3pF
6R8	6.8pF

(5) Capacitance tolerance

N	±0.3pF
D	±0.5pF
F	±1pF
G	±2pF

(6) Packaging style

T	Taping
---	--------

(7) Varistor voltage and TDK internal code

SHAPES AND DIMENSIONS

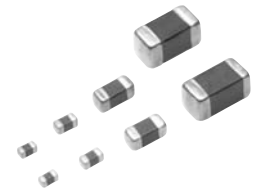
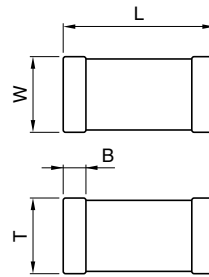

Dimensions in mm

Type	L	W	T	B min.	Weight (mg)typ.
0402	0.4±0.02	0.2±0.02	0.2±0.02	0.07	0.1
0603	0.6±0.03	0.3±0.03	0.3±0.03	0.1	0.2
1005	1.0±0.05	0.5±0.05	0.5±0.05	0.1	1.2
1608	1.6±0.1	0.8±0.1	0.8±0.1	0.2	5

RECOMMENDED PC BOARD PATTERN

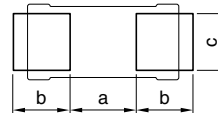

Dimensions in mm

Type	a	b	c
0402	0.2	0.15 to 0.2	0.18 to 0.2
0603	0.25 to 0.35	0.2 to 0.3	0.25 to 0.35
1005	0.3 to 0.5	0.35 to 0.45	0.4 to 0.6
1608	0.6 to 0.8	0.6 to 0.8	0.6 to 0.8

ELECTRICAL CHARACTERISTICS

Part No.	Capacitance C(pF) [1MHz, 1Vrms]	Maximum continuous voltage (Rated voltage) Vdc(V) max.	Insulation resistance Rdc(MΩ) [3Vrms] min.	Varistor voltage V _{1mA} (V)[DC1mA] typ.	Packaging quantities (Taping) (pieces/reel)
0402 type					
AVRL041E1R1NTA	1.1[0.8 to 1.4]	25	10	39	20,000
0603 type					
AVRL061E1R1NTA	1.1[0.8 to 1.4]	25	10	39	15,000
1005 type					
AVRL101A1R1NTA	1.1[0.8 to 1.4]	10	10	90	10,000
AVRL101A1R1NTB	1.1[0.8 to 1.4]	10	10	39	
AVRL101C2R2DTA	2.2[1.7 to 2.7]	16	10	90	
AVRL101A3R3FTA	3.3[2.3 to 4.3]	10	10	27	
AVRL101A6R8GTA	6.8[4.8 to 8.8]	10	10	27	
1608 type					
AVRL161A1R1NTA	1.1[0.8 to 1.4]	10	10	90	4,000
AVRL161A1R1NTB	1.1[0.8 to 1.4]	10	10	39	
AVRL161A3R3FTA	3.3[2.3 to 4.3]	10	10	27	
AVRL161A6R8GTA	6.8[4.8 to 8.8]	10	10	27	

TERMINOLOGY

Item	Unit	Terminology
Capacitance	C (pF)	Capacitance measured at 1MHz of oscillator frequency and 1Vrms of oscillator voltage.
Maximum continuous voltage (Rated voltage)	Vdc (V)	Maximum DC voltage that can be applied continuously. Varistor leakage current: 50μA max. (Within the range of maximum allowable circuit voltage)
Insulation resistance	Rdc (MΩ)	Insulation resistance appearing across the varistor when specified voltage is applied.
Varistor voltage (Breakdown voltage)	V _{1mA} (V)	Voltage measured across the varistor when DC1mA is applied.

• All specifications are subject to change without notice.

TYPICAL ELECTRICAL CHARACTERISTICS CURRENT vs. VOLTAGE CHARACTERISTICS

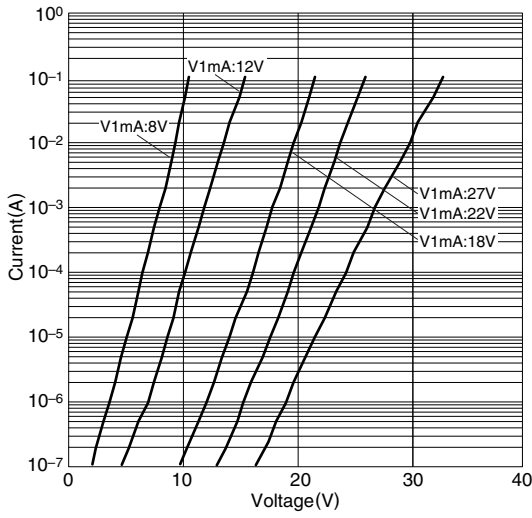

IMPEDANCE vs. FREQUENCY CHARACTERISTICS

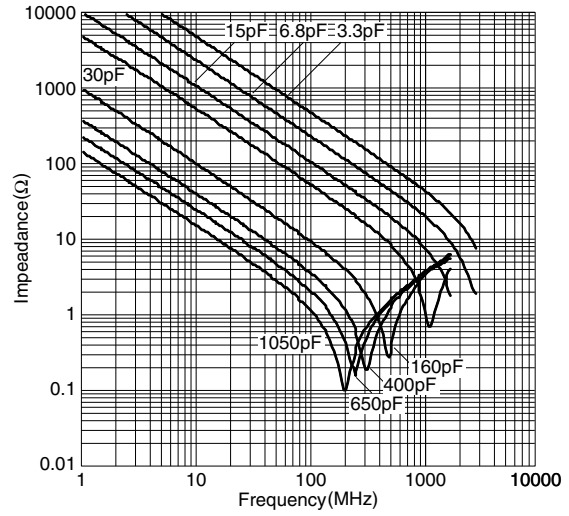

TRANSMISSION CHARACTERISTICS

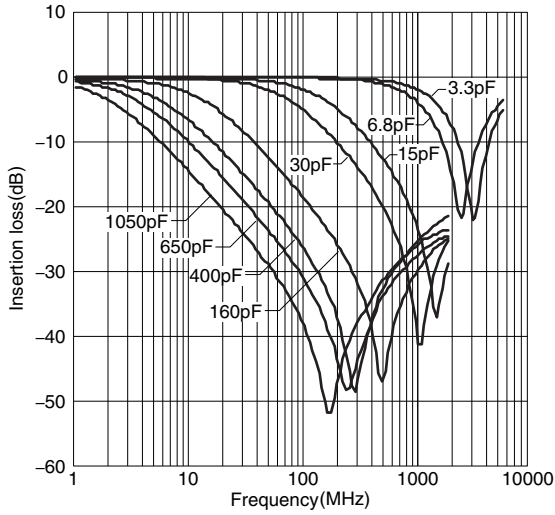

CAPACITANCE vs. FREQUENCY CHARACTERISTICS

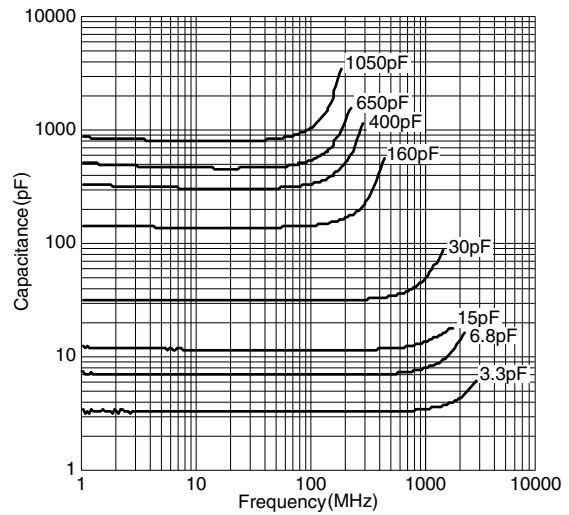

• All specifications are subject to change without notice.

ELECTROSTATIC DISCHARGE TESTS

TEST CONDITIONS

150pF, 330Ω contact discharge
Charged voltage /8kV, 0.1s interval

MEASURING CIRCUIT

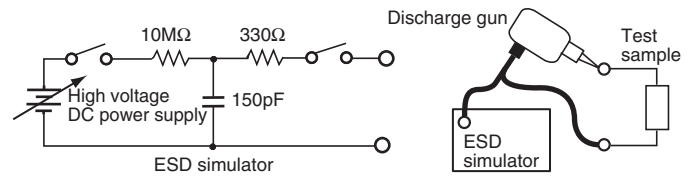

AVR-M0603 TYPE

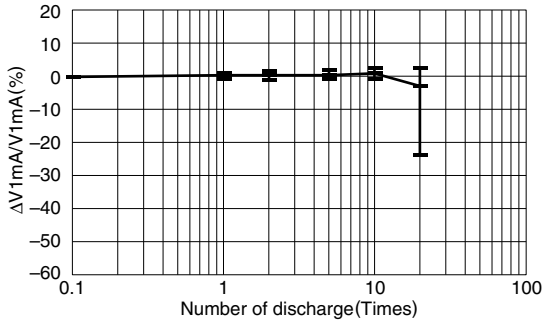

AVR-M1005 TYPE

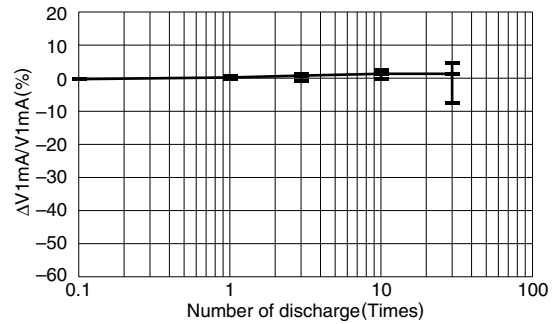

AVR-M1608 TYPE

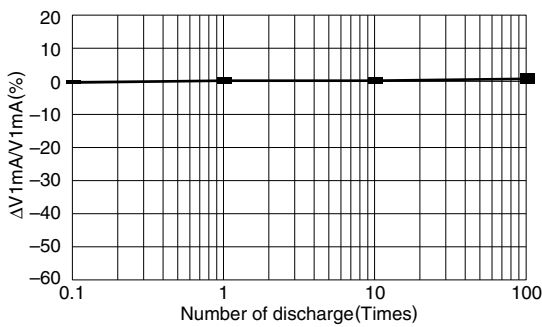

AVRL101A3R3F

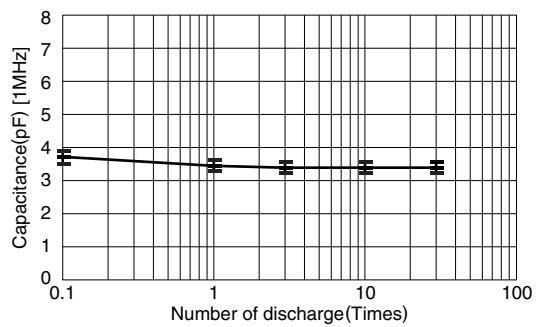

• All specifications are subject to change without notice.

ELECTROSTATIC ABSORPTION CHARACTERISTICS

DISCHARGE CURRENT WAVEFORM

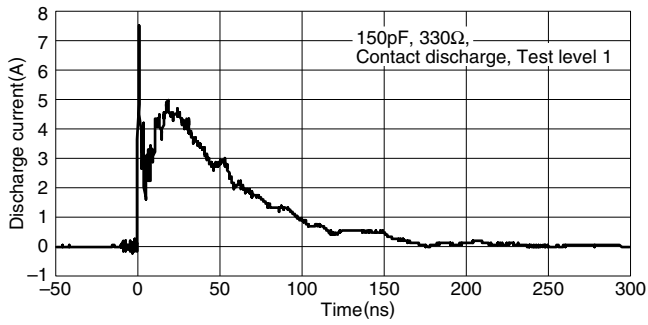

WAVEFORM PARAMETERS [IEC61000-4-2]

Test level	ESD Charge voltage (kV)	First peak current of discharge (A)	Rise time (ns)
1	2	7.5	0.7 to 1.0
2	4	15	0.7 to 1.0
3	6	22.5	0.7 to 1.0
4	8	30	0.7 to 1.0

DISCHARGE VOLTAGE WAVEFORM

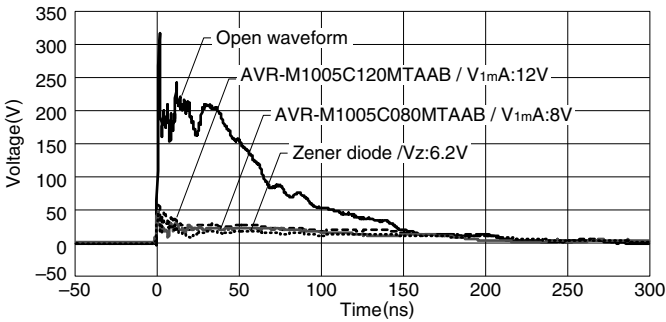

MEASURING CIRCUIT

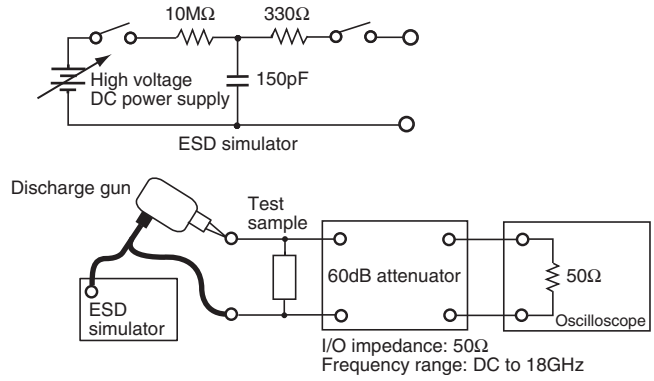

**ESD ABSORPTION CHARACTERISTICS
COMPARISON OF VARIOUS ELEMENTS**

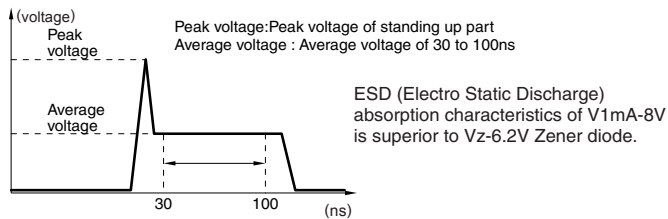
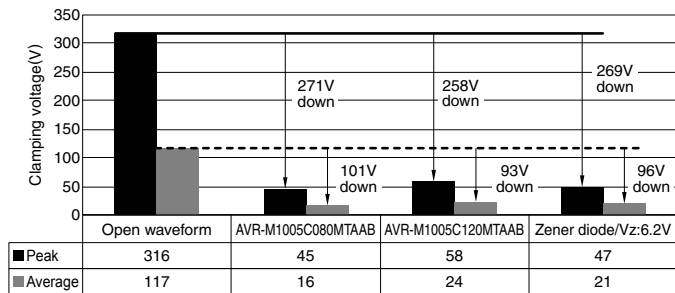

• All specifications are subject to change without notice.

MERITS OF REPLACEMENT FROM ZENER DIODE

(1) Reduction in the number of parts

REDUCTION EXAMPLES

Zener diode+capacitor

Chip varistor

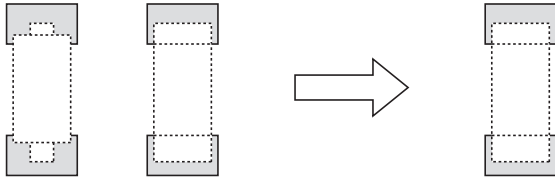

EXAMPLE OF REPLACEMENT AT AUDIO TERMINAL

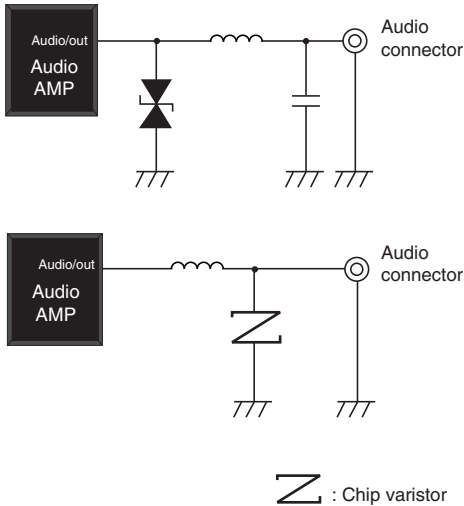

APPLICATION EXAMPLES

SMART PHONE

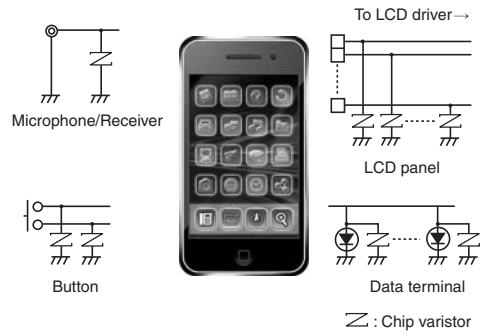

AUDIO/VIDEO

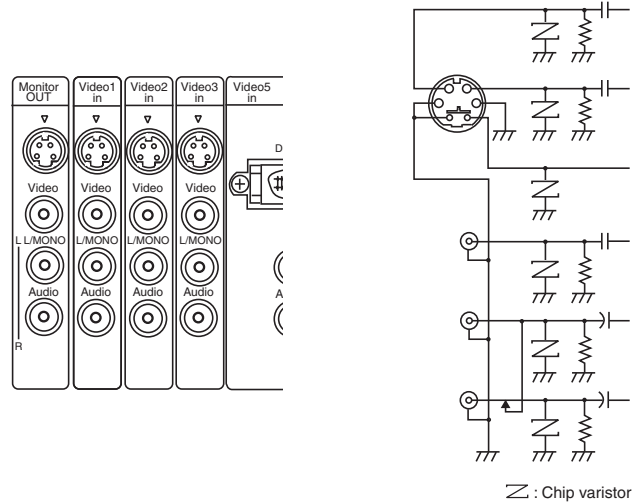

(2) Improved electrostatic absorption capability

COMPARE DATA OF CHIP VARISTOR AND ZENER DIODE ABOUT IC PROTECTION

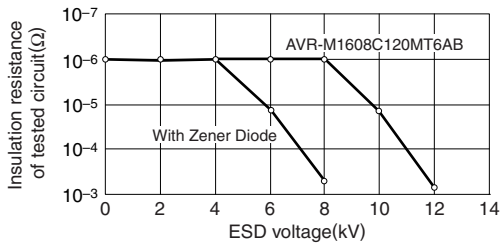

CMOS: D74HC04C
 ESD generator : Noise Laboratory Co.,Ltd., ESS -630A
 200pF-0Ω method model equipment
 Contact type discharge
 ESD applied point: Vcc-ground

APPLICATION EXAMPLES

USB 2.0

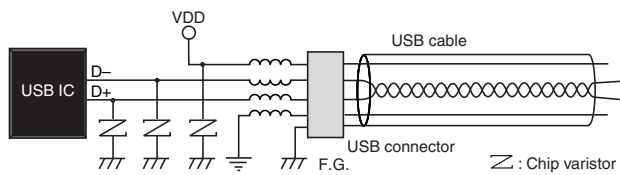

MEASURING CIRCUIT

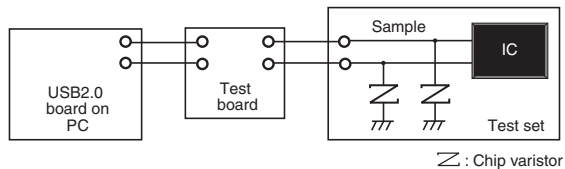

WITHOUT VARISTOR

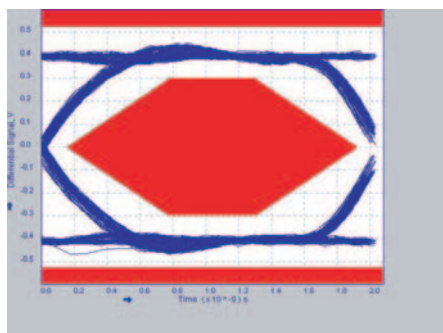

WITH VARISTOR

AVRL101A3R3FTA (3.3pF)

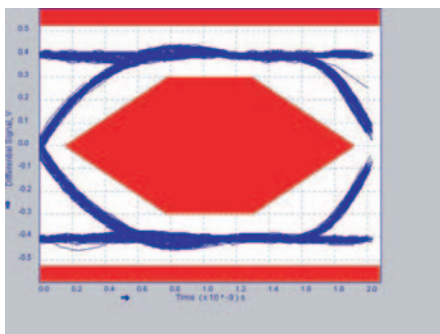

AVRL101A6R8GTA (6.8pF)

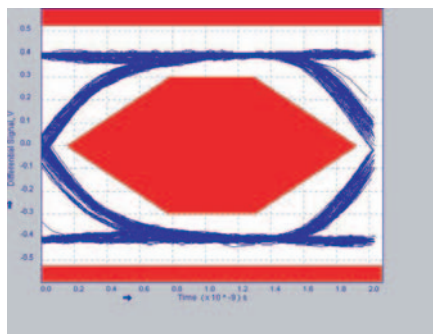

• All specifications are subject to change without notice.