

MMIC VCO w/ HALF FREQUENCY OUTPUT & DIVIDE-BY-16, 20.9 - 23.9 GHz



Typical Applications

The HMC738LP4(E) is ideal for:

- Point-to-Point Radios
- Point-to-Multi-Point Radios / LMDS
- VSAT

Features

- Pout: +9 dBm
- Phase Noise: -95 dBc/Hz @ 100 kHz Typ.
- No External Resonator Needed
- 24 Lead 4x4mm SMT Package: 16mm²

Functional Diagram

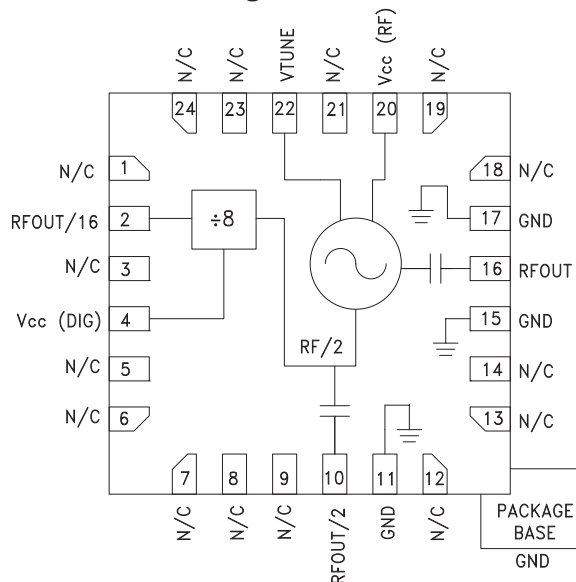

General Description

The HMC738LP4(E) is a GaAs InGaP Heterojunction Bipolar Transistor (HBT) MMIC VCO. The HMC738LP4(E) integrates a resonator, negative resistance device, varactor diode and divide-by-16 prescaler. The VCO's phase noise performance is excellent over temperature, shock, and process due to the oscillator's monolithic structure. Power output is +9 dBm typical from a 5V supply voltage. The voltage controlled oscillator is packaged in a low cost leadless QFN 4x4 mm surface mount package

Electrical Specifications, $T_A = +25^\circ\text{C}$, $V_{cc}(\text{RF})$, $V_{cc}(\text{DIG}) = +5\text{V}$

| Parameter | Min. | Typ. | Max. | Units | |
|---|--|-----------------|------------------|-----------------------|----|
| Frequency Range | F_o $F_o/2$ | 20.9 - 23.9 | | GHz | |
| Power Output | RF OUT RF OUT/2 RF OUT/16 | 3 -3.5 -7 | 15 +3.5 -1 | dBm dBm | |
| SSB Phase Noise @ 100 kHz Offset, $V_{tune} = +5\text{V}$ @ RF Output | | -95 | | dBc/Hz | |
| Tune Voltage | V_{tune} | 1 | 13 | V | |
| Supply Current | $I_{cc}(\text{RF})$, $I_{cc}(\text{DIG})$ | 160 | 200 | 220 | mA |
| Tune Port Leakage Current ($V_{tune} = 13\text{V}$) | | | 10 | μA | |
| Output Return Loss | | 3 | | dB | |
| Harmonics/Subharmonics | 1/2 3/2 | -23 -40 | | dBc dBc | |
| Pulling (into a 2.0:1 VSWR) | | 22 | | MHz pp | |
| Pushing @ $V_{tune} = 5\text{V}$ | | -90 | | MHz/V | |
| Frequency Drift Rate | | 3.5 | | MHz/ $^\circ\text{C}$ | |

Information furnished by Analog Devices is believed to be accurate and reliable. However, no responsibility is assumed by Analog Devices for its use, nor for any infringements of patents or other rights of third parties that may result from its use. Specifications subject to change without notice. No license is granted by implication or otherwise under any patent or patent rights of Analog Devices. Trademarks and registered trademarks are the property of their respective owners.

For price, delivery, and to place orders: Analog Devices, Inc., One Technology Way, P.O. Box 9106, Norwood, MA 02062-9106
Phone: 781-329-4700 • Order online at www.analog.com
Application Support: Phone: 1-800-ANALOG-D



MMIC VCO w/ HALF FREQUENCY OUTPUT & DIVIDE-BY-16, 20.9 - 23.9 GHz

Frequency vs. Tuning Voltage, $T = 25^{\circ}\text{C}$

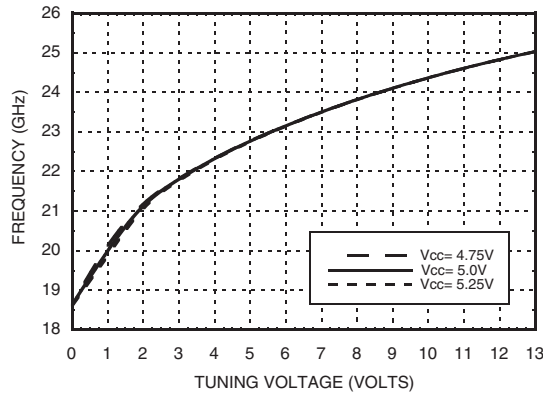

Frequency vs. Tuning Voltage, $V_{cc} = +5V$

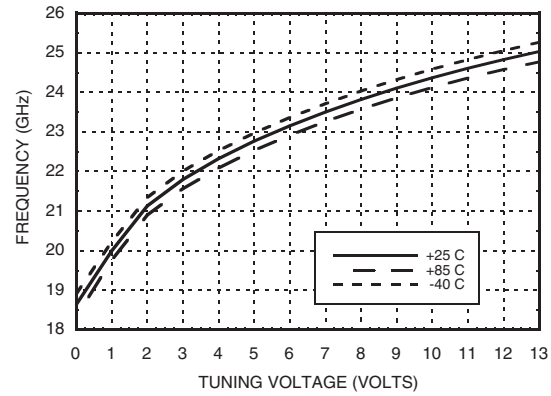

Sensitivity vs. Tuning Voltage, $V_{cc} = +5V$

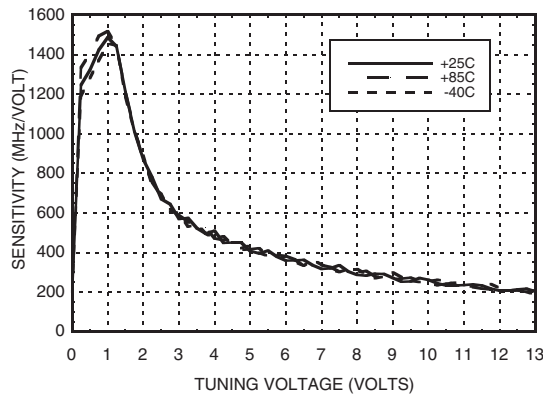

Output Power vs. Tuning Voltage, $V_{cc} = +5V$

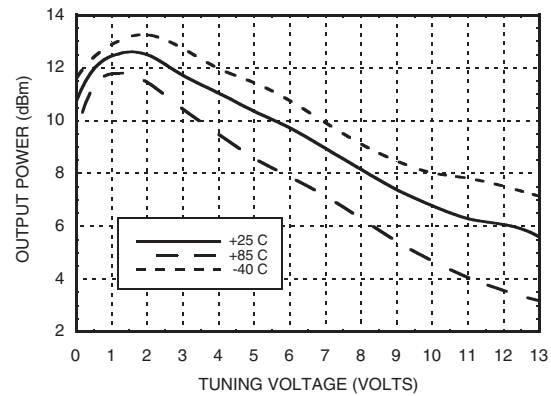

SSB Phase Noise vs. Tuning Voltage

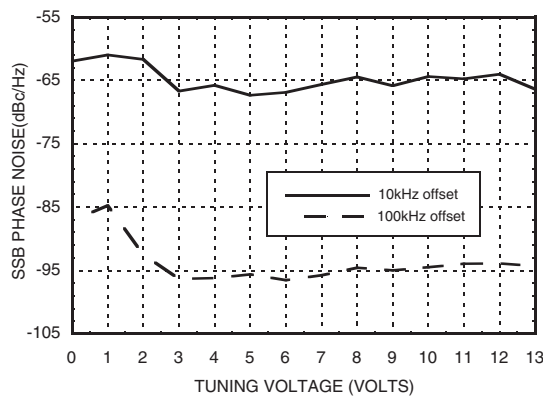

SSB Phase Noise @ $V_{tune} = 5V$

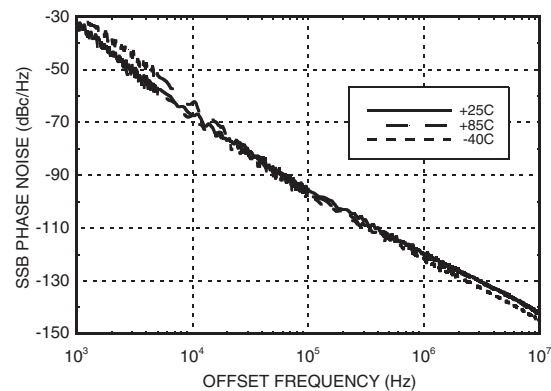

Information furnished by Analog Devices is believed to be accurate and reliable. However, no responsibility is assumed by Analog Devices for its use, nor for any infringements of patents or other rights of third parties that may result from its use. Specifications subject to change without notice. No license is granted by implication or otherwise under any patent or patent rights of Analog Devices. Trademarks and registered trademarks are the property of their respective owners.

For price, delivery, and to place orders: Analog Devices, Inc., One Technology Way, P.O. Box 9106, Norwood, MA 02062-9106 Phone: 781-329-4700 • Order online at www.analog.com Application Support: Phone: 1-800-ANALOG-D



MMIC VCO w/ HALF FREQUENCY OUTPUT & DIVIDE-BY-16, 20.9 - 23.9 GHz

RFOUT/2 Frequency vs. Tuning Voltage, Vcc= +5V

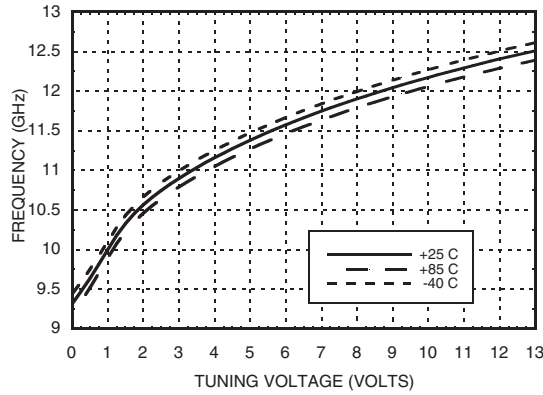

RFOUT/2 Output Power vs. Tuning Voltage, Vcc= +5V

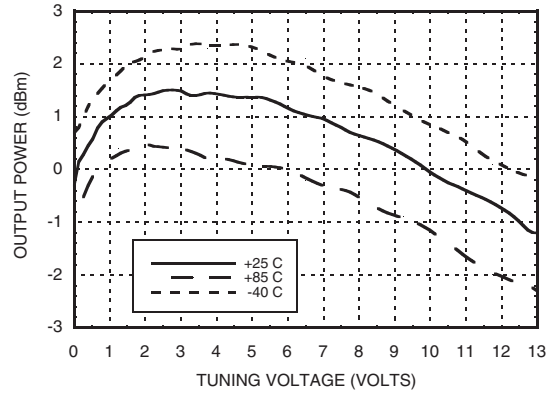

Divide-by-16 Frequency vs. Tuning Voltage, Vcc= +5V

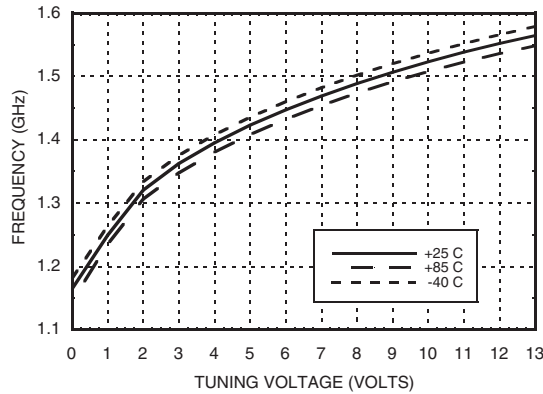

Divide-by-16 Output Power vs. Tuning Voltage, Vcc= +5V

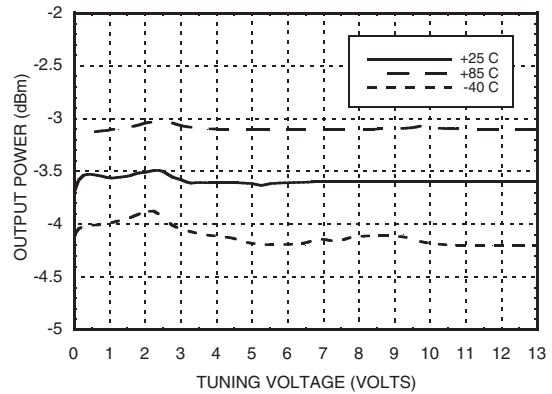

Absolute Maximum Ratings

| | |
|---|----------------|
| Vcc (RF), Vcc (DIG) | +5.5V |
| Vtune | 0 to +15V |
| Junction Temperature | 135° C |
| Continuous P _{diss} (T= 85 °C) (derate 23 mW/° above 85 °C) | 1.2 W |
| Thermal Resistance (junction to ground paddle) | 43 °C/W |
| Storage Temperature | -65 to +150 °C |
| Operating Temperature | -40 to +85 °C |

Typical Supply Current vs. Vcc

| Vcc (V) | I _{cc} (mA) |
|---------|----------------------|
| 4.75 | 175 |
| 5.0 | 200 |
| 5.25 | 220 |

Note: VCO will operate over full voltage range shown above.



**ELECTROSTATIC SENSITIVE DEVICE
OBSERVE HANDLING PRECAUTIONS**



MMIC VCO w/ HALF FREQUENCY OUTPUT & DIVIDE-BY-16, 20.9 - 23.9 GHz

Outline Drawing

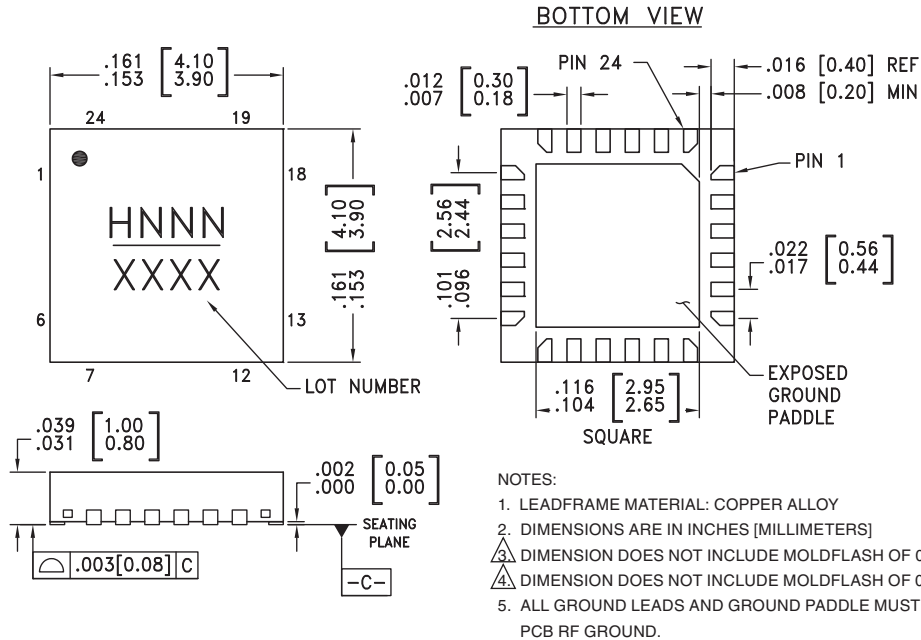

Package Information

| Part Number | Package Body Material | Lead Finish | MSL Rating | Package Marking ^[3] |
|-------------|--|---------------|---------------------|--------------------------------|
| HMC738LP4 | Low Stress Injection Molded Plastic | Sn/Pb Solder | MSL1 ^[1] | H738 XXXX |
| HMC738LP4E | RoHS-compliant Low Stress Injection Molded Plastic | 100% matte Sn | MSL1 ^[2] | H738 XXXX |

[1] Max peak reflow temperature of 235 °C
 [2] Max peak reflow temperature of 260 °C
 [3] 4-Digit lot number XXXX

Pin Descriptions

| Pin Number | Function | Description | Interface Schematic |
|---|-----------|---|---------------------|
| 1, 3, 5, 6, 7, 8, 9, 12, 13, 14, 18, 19, 21, 23, 24 | N/C | No Connection required. These pins may be connected to RF/DC ground without affecting performance. | |
| 2 | RFOUT/16 | RF/16 Divided Output. Requires DC Block. | |
| 4 | Vcc (DIG) | Supply voltage for prescaler. Can be omitted if prescaler is not needed to conserve approximately 100 mA. | |

Information furnished by Analog Devices is believed to be accurate and reliable. However, no responsibility is assumed by Analog Devices for its use, nor for any infringements of patents or other rights of third parties that may result from its use. Specifications subject to change without notice. No license is granted by implication or otherwise under any patent or patent rights of Analog Devices. Trademarks and registered trademarks are the property of their respective owners.

For price, delivery, and to place orders: Analog Devices, Inc., One Technology Way, P.O. Box 9106, Norwood, MA 02062-9106
 Phone: 781-329-4700 • Order online at www.analog.com
 Application Support: Phone: 1-800-ANALOG-D



MMIC VCO w/ HALF FREQUENCY OUTPUT & DIVIDE-BY-16, 20.9 - 23.9 GHz

Pin Descriptions (Continued)

| Pin Number | Function | Description | Interface Schematic |
|------------|----------|---|---------------------|
| 10 | RFOUT/2 | Half frequency output (AC coupled) | |
| 11, 15, 17 | GND | Package bottom has an exposed metal paddle that must be RF & DC grounded. | |
| 16 | RFOUT | RF output (AC coupled). | |
| 20 | Vcc (RF) | Supply Voltage | |
| 22 | VTUNE | Control Voltage Input. Modulation port bandwidth dependent on drive source impedance. | |

Typical Application Circuit

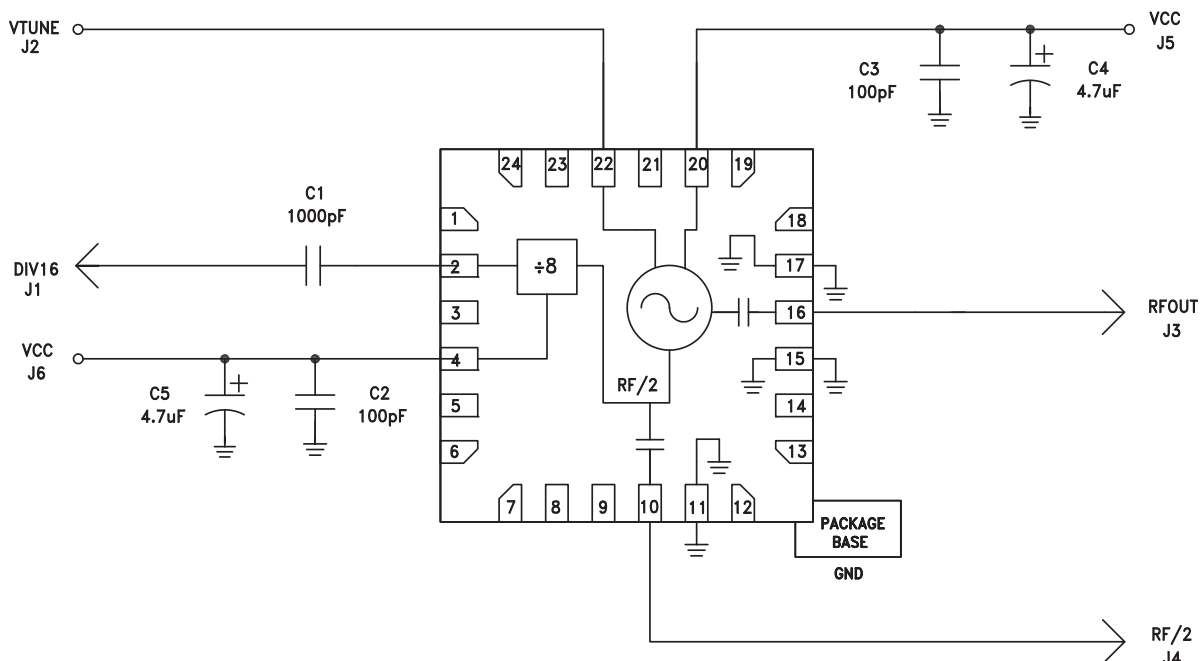

Information furnished by Analog Devices is believed to be accurate and reliable. However, no responsibility is assumed by Analog Devices for its use, nor for any infringements of patents or other rights of third parties that may result from its use. Specifications subject to change without notice. No license is granted by implication or otherwise under any patent or patent rights of Analog Devices. Trademarks and registered trademarks are the property of their respective owners.

For price, delivery, and to place orders: Analog Devices, Inc., One Technology Way, P.O. Box 9106, Norwood, MA 02062-9106 Phone: 781-329-4700 • Order online at www.analog.com Application Support: Phone: 1-800-ANALOG-D



MMIC VCO w/ HALF FREQUENCY OUTPUT & DIVIDE-BY-16, 20.9 - 23.9 GHz

Evaluation PCB

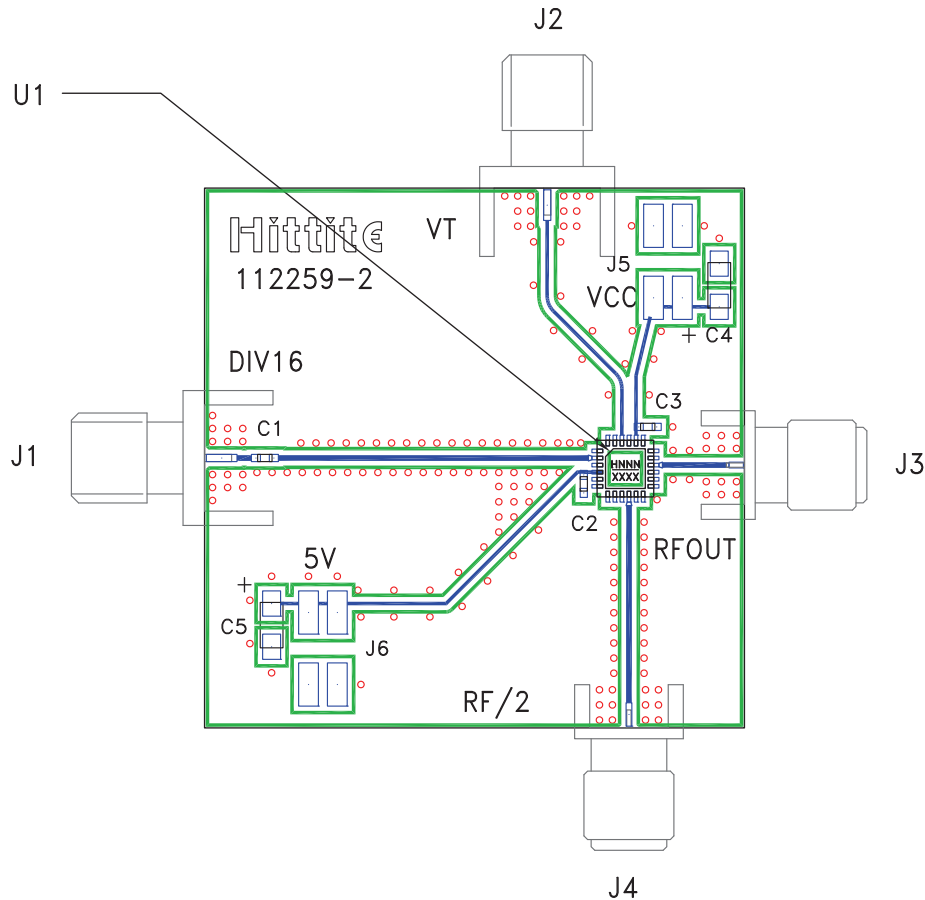

List of Materials for Evaluation PCB 112261 [1]

| Item | Description |
|---------|--------------------------------|
| J1, J2 | PCB Mount SMA RF Connector |
| J3 | PCB Mount K-Connector |
| J4 | PCB Mount SRI SMA Connector |
| J5 - J6 | 2 mm SMT 8 Pin Molex Header |
| C1 | 1,000 pF Capacitor, 0402 Pkg. |
| C2, C3 | 100 pF Capacitor, 0402 Pkg. |
| C4, C5 | 4.7 μ F Tantalum Capacitor |
| U1 | HMC738LP4(E) |
| PCB [2] | 112259 Eval Board |

[1] Reference this number when ordering complete evaluation PCB

[2] Circuit Board Material: Rogers 4350

The circuit board used in the application should use RF circuit design techniques. Signal lines should have 50 Ohm impedance while the package ground leads and backside ground slug should be connected directly to the ground plane similar to that shown. A sufficient number of via holes should be used to connect the top and bottom ground planes. The evaluation circuit board shown is available from Hittite upon request.