

J-CAP™ Series

Highest Joules/cc Conductive Polymer Solid Electrolytic Chip Capacitors



FEATURES

- Highest Energy per Volume
- Fast DCL Drop With Voltage Applied After Reflow
- Benign Failure Mode Under Recommended Use Conditions
- Low ESR
- Undertab Terminations Layout:
 - High Volumetric Efficiency
 - Low Profile Case Sizes
 - High Capacitance in Smaller Dimensions
 - Close Positioning of Several Parts for Efficient High Density PCB Layout
- 3x Reflow 260°C Compatible
- 100% Surge Current Tested

APPLICATIONS

- Power Backup for SSDs (MLC, SLC, EFD, PCIe)
- Battery-Powered Portable Equipment
- Industrial Alarms
- Smart Power Meters
- Mobile Devices

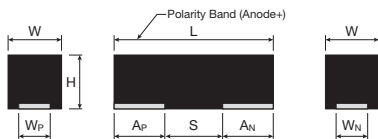
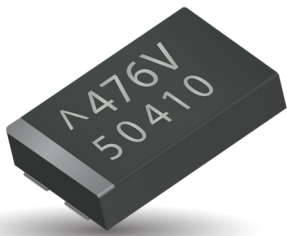

CASE DIMENSIONS UNDERTAB millimeters (inches)

| Code | EIA Code | EIA Metric | L±0.20 (0.008) | W+0.20 (0.008) -0.10 (0.004) | H max. | WP±0.10 (0.004) | WN±0.10 (0.004) | AP±0.10 (0.004) | AN±0.10 (0.004) | S Min. |
|------|----------|------------|-------------------------|------------------------------|--------------|-----------------|-----------------|-------------------------|-------------------------|--------------|
| L | 1210 | 3528-10 | 3.50 (0.138) | 2.80 (0.110) | 1.00 (0.039) | 2.50 (0.098) | 2.10 (0.083) | 1.15 (0.045) | 1.35 (0.053) | 1.00 (0.039) |
| T | 1210 | 3528-12 | 3.50 (0.138) | 2.80 (0.110) | 1.20 (0.047) | 2.50 (0.098) | 2.10 (0.083) | 1.15 (0.045) | 1.35 (0.053) | 1.00 (0.039) |
| X | 2917 | 7343-15 | 7.30 (0.287) | 4.30 (0.169) | 1.50 (0.059) | 3.25 (0.128) | 3.25 (0.128) | 2.00 (0.079) | 3.20 (0.126) | 2.10 (0.083) |
| Z | 2917 | 7343-15 | 7.30±0.30 (0.287±0.012) | 4.30±0.30 (0.169±0.012) | 1.50 (0.059) | 2.40 (0.094) | 2.40 (0.094) | 1.30±0.30 (0.051±0.012) | 1.30±0.30 (0.051±0.012) | 4.40 (0.173) |
| 4 | 2924 | 7361-20 | 7.30 (0.287) | 6.10 (0.240) | 2.00 (0.079) | 4.75 (0.187) | 4.75 (0.187) | 2.00 (0.079) | 3.20 (0.126) | 2.10 (0.083) |
| 8 | 2924 | 7361-20 | 7.30±0.30 (0.287±0.012) | 6.10 (0.240) | 2.00 (0.079) | 4.45 (0.175) | 4.45 (0.175) | 1.60±0.30 (0.063±0.012) | 1.60±0.30 (0.063±0.012) | 3.80 (0.150) |

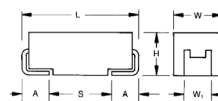

MAXIMUM ENERGY PER CASE SIZE

| Case Size | H Max (mm) | Max Energy (mJ) |
|-----------|------------|-----------------|
| C | 2.8 | 5.8 |
| D | 3.1 | 21.8 |
| E | 4.3 | 11.9 |
| H | 1.5 | 3.3 |
| L | 1.0 | 1.8 |
| T | 1.2 | 4.7 |
| X | 1.5 | 18.2 |
| Z | 1.5 | 18.2 |
| 4 | 2.0 | 43.0 |
| 5 | 4.0 | 46.6 |
| 8 | 2.0 | 38.8 |

CASE DIMENSIONS J-LEAD millimeters (inches)

| Code | EIA Code | EIA Metric | L±0.20 (0.008) | W+0.20 (0.008) -0.10 (0.004) | H+0.20 (0.008) -0.10 (0.004) | W1±0.20 (0.008) | A+0.30 (0.012) -0.20 (0.008) | S Min. |
|------|----------|------------|----------------|------------------------------|------------------------------|-----------------|------------------------------|--------------|
| C | 2312 | 6032-28 | 6.00 (0.236) | 3.20 (0.126) | 2.60 (0.102) | 2.20 (0.087) | 1.30 (0.051) | 2.90 (0.114) |
| D | 2917 | 7343-31 | 7.30 (0.287) | 4.30 (0.169) | 2.90 (0.114) | 2.40 (0.094) | 1.30 (0.051) | 4.40 (0.173) |
| E | 2917 | 7343-43 | 7.30 (0.287) | 4.30 (0.169) | 4.10 (0.162) | 2.40 (0.094) | 1.30 (0.051) | 4.40 (0.173) |
| H | 1210 | 3528-15 | 3.50 (0.138) | 2.80 (0.110) | 1.50 (0.059) max. | 2.20 (0.087) | 0.80 (0.031) | 1.40 (0.055) |
| 5 | 2917 | 7343-40 | 7.30 (0.287) | 4.30 (0.169) | 3.80 (0.150) | 2.40 (0.094) | 1.30 (0.051) | 4.40 (0.173) |

W₁ dimension applies to the termination width for A dimensional area only.

MARKING

C, D, E, H, L, T, X, Z, 5 CASE

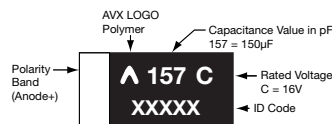

4, 8 CASE

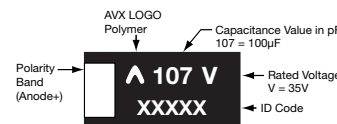

HOW TO ORDER

TCN

Type
TCJ
TCN

4

Case Size
See table above

158

Capacitance Code
pF code: 1st two digits represent significant figures, 3rd digit represents multiplier

M

Tolerance
M = ±20%

006

Rated DC Voltage
006 = 6.3Vdc 020 = 20Vdc
010 = 10Vdc 025 = 25Vdc
016 = 16Vdc 035 = 35Vdc

R

Packaging
R = Pure Tin 7" Reel
S = Pure Tin 13" Reel (J-Lead)

0055

ESR in mΩ

E

Additional Character
E = Black resin (it is possible to order PN without "E" as identical product)

TECHNICAL SPECIFICATIONS

| | | | | | | | | |
|-------------------------------|--|-----|----|----|----|----|----|----|
| Technical Data: | All technical data relate to an ambient temperature of +25°C | | | | | | | |
| Capacitance Range: | 4.7µF to 1500µF | | | | | | | |
| Capacitance Tolerance: | ±20% | | | | | | | |
| Leakage Current DCL: | 0.1CV | | | | | | | |
| Rated Voltage DC (VR) | ≤ +85°C: | 6.3 | 10 | 16 | 20 | 25 | 35 | 50 |
| Surge Voltage (VS) | ≤ +85°C: | 8 | 13 | 21 | 26 | 33 | 46 | 65 |
| Temperature Range: | -55°C up to +125°C | | | | | | | |

NOTE: Conductive Polymer Capacitors are designed to operate within the limits of the environmental conditions specified for each series. If operated continuously at their maximum temperature and / or humidity limit, or beyond these limits, capacitors may exhibit a parametric shift in capacitance and increases in ESR. These changes may occur earlier if the specified environmental conditions are exceeded. Similarly, their normal operational time period will be significantly extended if their general duty cycle includes operation below maximum temperature within humidity controlled environments. Careful attention should be paid to maximum temperature with associated high humidity environments as well as voltage derating, ripple current and current surges. Please reference the AVX Conductive Polymer Capacitor Guidelines for more information or contact factory for application assistance.

CAPACITANCE AND RATED VOLTAGE RANGE (LETTER DENOTES CASE SIZE)

| Capacitance | | Rated Voltage DC (VR) to 85°C, [mJ] | | | | | | | | | | | | | |
|-------------|------|-------------------------------------|--------|-------------------|--------|-------------------|--------|--------|--------|-----------------|--------|-------------------|--------|---------|--------|
| µF | Code | 6.3V (J) | | 10V (A) | | 16V (C) | | 20V(D) | | 25V (E) | | 35V (V) | | 50V (T) | |
| 4.7 | 475 | | | | | | | | | | | L(300)/ T(200) | [1.8] | | |
| 6.8 | 685 | | | | | | | | | | | | | C(200) | [5.4] |
| 10 | 106 | | | | | | | | | | | T(150), 200 | [3.9] | D(120) | [8.0] |
| 15 | 456 | | | | | | | | | | | C(200) | [5.8] | E(70) | [11.9] |
| 22 | 226 | | | | | | | | | T(200) | [4.3] | D(100) | [8.5] | | |
| 33 | 336 | | | | | H(150)/ T(200) | [3.3] | | | | | D(70) | [12.8] | | |
| 47 | 476 | | | C(100)/ H(100) | [1.7] | T(150) | [4.7] | | | X(100) | [9.2] | X(150)/ Z(150) | [18.2] | | |
| 68 | 686 | H(100) | [0.8] | D(45) | [2.5] | D(50) | [6.7] | D(55) | [8.4] | D(70) | [13.3] | | | | |
| 100 | 107 | | | D(45) | [3.6] | D(50) | [9.9] | D(55) | [12.4] | D(70) | [19.6] | 4(100)/ 8(100) | [38.8] | | |
| 150 | 157 | T(200) | [1.7] | D(45) | [5.4] | X(100) | [14.9] | | | 4(70)/ 8(70) | [29.3] | | | | |
| 220 | 227 | H(170) | [2.6] | D(40) | [7.9] | D(50) 4(70) | [21.8] | 4(100) | [27.2] | 4(100) | [43.0] | | | | |
| 330 | 337 | D(40) | [3.8] | 5(100) | [11.9] | 4(70) 5(100) | [32.7] | | | | | | | | |
| 470 | 477 | X(50) | [5.4] | | | 5(100) | [46.6] | | | | | | | | |
| 1000 | 108 | 4(55) | [11.6] | | | | | | | | | | | | |
| 1500 | 158 | 4(55) | [17.4] | | | | | | | | | | | | |

Released ratings (ESR ratings in mOhms in parentheses) [Energy in mJ]

Engineering samples - please contact AVX

Note: Voltage ratings are minimum values. AVX reserves the right to supply higher voltage ratings in the same case size, to the same reliability standards.

RATINGS & PART NUMBER REFERENCE

| AVX Part No. | Case Size | Capacitance (µF) | Rated Voltage (V) | Maximum Operating Temperature (°C) | DCL Max. (µA) | DF Max. (%) | ESR Max. @ 100kHz (mΩ) | 1000kHz RMS Current (mA) 45°C | Product Category | MSL | ENERGY | | | |
|-------------------|-----------|------------------|-------------------|------------------------------------|---------------|-------------|------------------------|-------------------------------|------------------|-----|-------------|-------------------------------------|-----------------------------------|--|
| | | | | | | | | | | | Energy (mJ) | Energy/volume (mJ/cm ³) | Energy/area (mJ/cm ²) | |
| 6.3 Volt @ 85°C | | | | | | | | | | | | 6.3 Volt @ 85°C | | |
| TCJH686M006#0100E | H | 68 | 6.3 | 105 | 40.8 | 6 | 100 | 1000 | 3 | 3 | 0.8 | 54 | 8.0 | |
| TCNT157M006#0200E | T | 150 | 6.3 | 105 | 90 | 10 | 200 | 700 | 3 | 4 | 1.7 | 147 | 17.7 | |
| TCJH227M006#0170E | H | 220 | 6.3 | 105 | 132 | 10 | 170 | 800 | 3 | 3 | 2.6 | 173 | 26.0 | |
| TCJD337M006#0040E | D | 330 | 6.3 | 105 | 198 | 6 | 40 | 2400 | 2 | 3 | 3.8 | 42 | 12.2 | |
| TCNX477M006#0050E | X | 470 | 6.3 | 85 | 282 | 10 | 50 | 1900 | 5 | 5 | 5.4 | 115 | 17.3 | |
| TCN4108M006#0055E | 4 | 1000 | 6.3 | 85 | 600 | 20 | 55 | 1860 | 5 | 4 | 11.6 | 130 | 26.0 | |
| TCN4158M006#0055E | 4 | 1500 | 6.3 | 85 | 900 | 20 | 55 | 1860 | 5 | 4 | 17.4 | 195 | 39.0 | |
| 10 Volt @ 85°C | | | | | | | | | | | | 10 Volt @ 85°C | | |
| TCJH476M010#0100E | H | 47 | 10 | 105 | 47 | 6 | 100 | 1000 | 3 | 3 | 1.7 | 115 | 17.3 | |
| TCJC476M010#0100E | C | 47 | 10 | 125 | 47 | 6 | 100 | 1300 | 1 | 3 | 1.7 | 34 | 8.8 | |
| TCJD686M010#0045E | D | 68 | 10 | 105 | 68 | 6 | 45 | 2200 | 3 | 3 | 2.5 | 27 | 7.8 | |
| TCJD107M010#0045E | D | 100 | 10 | 105 | 100 | 6 | 45 | 2200 | 3 | 3 | 3.6 | 40 | 11.5 | |
| TCJD157M010#0045E | D | 150 | 10 | 105 | 150 | 6 | 45 | 2200 | 3 | 3 | 5.4 | 59 | 17.2 | |
| TCJD227M010#0040E | D | 220 | 10 | 105 | 220 | 6 | 40 | 2400 | 3 | 3 | 7.9 | 87 | 25.2 | |
| TCJ5337M010#0100E | 5 | 330 | 10 | 105 | 330 | 10 | 100 | 1300 | 2 | 3 | 11.9 | 100 | 37.8 | |
| 16 Volt @ 85°C | | | | | | | | | | | | 16 Volt @ 85°C | | |
| TCJH336M016#0150E | H | 33 | 16 | 105 | 52.8 | 6 | 150 | 800 | 3 | 3 | 3.3 | 223 | 33.4 | |
| TCNT336M016#0200E | T | 33 | 16 | 105 | 52.8 | 6 | 200 | 700 | 3 | 4 | 3.3 | 277 | 33.4 | |
| TCNT476M016#0150E | T | 47 | 16 | 105 | 75.2 | 6 | 150 | 800 | 3 | 4 | 4.7 | 395 | 47.6 | |
| TCJD686M016#0050E | D | 68 | 16 | 105 | 108.8 | 6 | 50 | 2100 | 2 | 3 | 6.7 | 74 | 21.5 | |
| TCJD107M016#0050E | D | 100 | 16 | 105 | 160 | 6 | 50 | 2100 | 2 | 3 | 9.9 | 109 | 31.6 | |
| TCNX157M016#0100E | X | 150 | 16 | 105 | 240 | 6 | 100 | 1300 | 3 | 4 | 14.9 | 316 | 47.4 | |
| TCJD227M016#0050E | D | 220 | 16 | 105 | 352 | 10 | 50 | 2100 | 2 | 3 | 21.8 | 240 | 69.5 | |
| TCN4227M016#0070E | 4 | 220 | 16 | 105 | 352 | 20 | 70 | 1650 | 2 | 4 | 21.8 | 245 | 49.0 | |
| TCN4337M016#0070E | 4 | 330 | 16 | 105 | 528 | 20 | 70 | 1650 | 3 | 4 | 32.7 | 367 | 73.5 | |
| TCJ5337M016#0100E | 5 | 330 | 16 | 105 | 528 | 10 | 100 | 1300 | 2 | 3 | 32.7 | 274 | 104.2 | |
| TCJ5477M016#0100E | 5 | 470 | 16 | 105 | 752 | 10 | 100 | 1300 | 3 | 3 | 46.6 | 391 | 148.5 | |
| 20 Volt @ 85°C | | | | | | | | | | | | 20 Volt @ 85°C | | |
| TCJD686M020#0055E | D | 68 | 20 | 105 | 136 | 6 | 55 | 2000 | 3 | 3 | 8.4 | 92 | 26.7 | |
| TCJD107M020#0055E | D | 100 | 20 | 105 | 200 | 6 | 55 | 2000 | 3 | 3 | 12.4 | 136 | 39.3 | |
| TCN4227M020#0100E | 4 | 220 | 20 | 85 | 440 | 10 | 100 | 1380 | 5 | 4 | 27.2 | 305 | 61.1 | |
| 25 Volt @ 85°C | | | | | | | | | | | | 25 Volt @ 85°C | | |
| TCNT226M025#0200E | T | 22 | 25 | 105 | 55 | 6 | 200 | 700 | 3 | 4 | 4.3 | 364 | 43.9 | |
| TCNX476M025#0100E | X | 47 | 25 | 105 | 117.5 | 6 | 100 | 1300 | 2 | 5 | 9.2 | 195 | 29.3 | |
| TCJD686M025#0070E | D | 68 | 25 | 105 | 170 | 6 | 70 | 1800 | 2 | 3 | 13.3 | 146 | 42.3 | |
| TCJD107M025#0070E | D | 100 | 25 | 105 | 250 | 6 | 70 | 1800 | 2 | 3 | 19.6 | 215 | 62.3 | |
| TCN4107M025#0100E | 4 | 100 | 25 | 105 | 250 | 6 | 100 | 1380 | 2 | 4 | 19.6 | 219 | 43.9 | |
| TCN4157M025#0070E | 4 | 150 | 25 | 105 | 375 | 6 | 70 | 1650 | 2 | 4 | 29.3 | 329 | 65.9 | |
| TCN8157M025#0070E | 8 | 150 | 25 | 105 | 375 | 8 | 70 | 1650 | 2 | 3 | 29.3 | 329 | 65.9 | |
| TCN4227M025#0100E | 4 | 220 | 25 | 105 | 550 | 10 | 100 | 1380 | 3 | 4 | 43.0 | 483 | 96.7 | |
| 35 Volt @ 85°C | | | | | | | | | | | | 35 Volt @ 85°C | | |
| TCNL475M035#0300E | L | 4.7 | 35 | 105 | 16.5 | 6 | 300 | 600 | 2 | 5 | 1.8 | 186 | 18.6 | |
| TCNT475M035#0200E | T | 4.7 | 35 | 105 | 16.5 | 10 | 200 | 700 | 3 | 4 | 1.8 | 154 | 18.6 | |
| TCNT106M035#0150E | T | 10 | 35 | 105 | 35 | 10 | 150 | 800 | 3 | 4 | 3.9 | 328 | 39.5 | |
| TCNT106M035#0200E | T | 10 | 35 | 105 | 35 | 10 | 200 | 700 | 3 | 4 | 3.9 | 328 | 39.5 | |
| TCJC156M035#0200E | C | 15 | 35 | 105 | 52.5 | 6 | 200 | 900 | 3 | 3 | 5.8 | 116 | 30.3 | |
| TCJD226M035#0100E | D | 22 | 35 | 105 | 77 | 6 | 100 | 1500 | 2 | 3 | 8.5 | 94 | 27.1 | |
| TCJD336M035#0070E | D | 33 | 35 | 105 | 115.5 | 6 | 70 | 1800 | 2 | 3 | 12.8 | 141 | 40.7 | |
| TCNX476M035#0150E | X | 47 | 35 | 105 | 165 | 10 | 150 | 1100 | 3 | 4 | 18.2 | 387 | 58.0 | |
| TCNZ476M035#0150E | Z | 47 | 35 | 105 | 165 | 10 | 150 | 1100 | 3 | 4 | 18.2 | 387 | 58.0 | |
| TCN4107M035#0100E | 4 | 100 | 35 | 105 | 350 | 10 | 100 | 1380 | 2 | 3 | 38.8 | 435 | 87.1 | |
| TCN8107M035#0100E | 8 | 100 | 35 | 105 | 350 | 10 | 100 | 1380 | 2 | 3 | 38.8 | 435 | 87.1 | |
| 50 Volt @ 85°C | | | | | | | | | | | | 50 Volt @ 85°C | | |
| TCJC685M050#0200E | C | 6.8 | 50 | 105 | 34 | 8 | 200 | 900 | 3 | 3 | 5.4 | 108 | 28.2 | |
| TCJD106M050#0120E | D | 10 | 50 | 105 | 50 | 10 | 120 | 1400 | 3 | 3 | 8.0 | 87 | 25.3 | |
| TCJE156M050#0070E | E | 15 | 50 | 105 | 75 | 6 | 70 | 1900 | 3 | 3 | 11.9 | 93 | 38.0 | |

Energy is calculated by this formula (consider derating factor):

$$\text{Energy} = \frac{1}{2} C \times ((V_r \times X)^2 - V_x^2)$$

where C = Capacitance

V_r = Rated Voltage

X = Recommended derating factor

V_x = 3V (invariable)

Moisture Sensitivity Level (MSL) is defined according to J-STD-020. All technical data relates to an ambient temperature of +25°C. Capacitance is measured at 120Hz, 0.5RMS with DC bias of 2.2 volts. DCL is measured at rated voltage after 5 minutes. ESR allowed to move up to 1.25 times catalog limit post mounting. For typical weight and composition see page 276.

NOTE: AVX reserves the right to supply higher voltage ratings in the same case size, to the same reliability standards.

RECOMMENDED DERATING FACTOR

Voltage and temperature derating as percentage of Vr

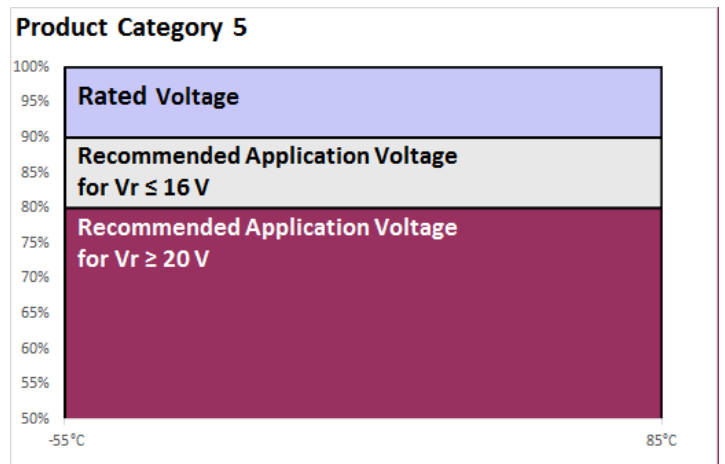
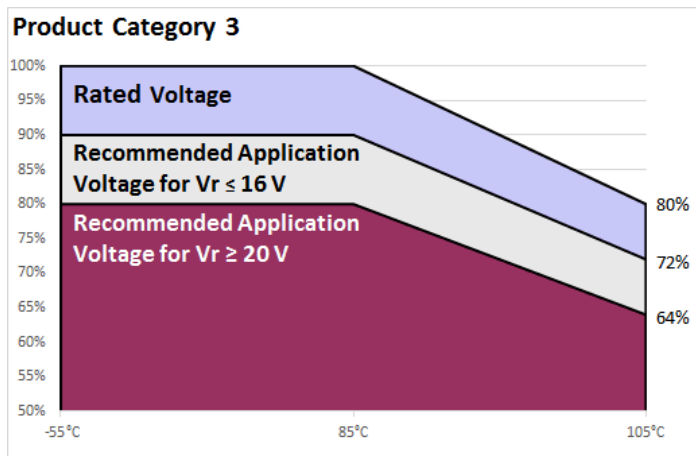
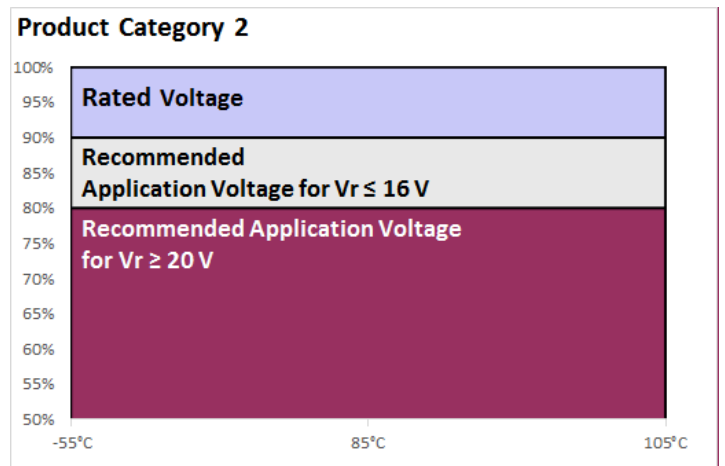
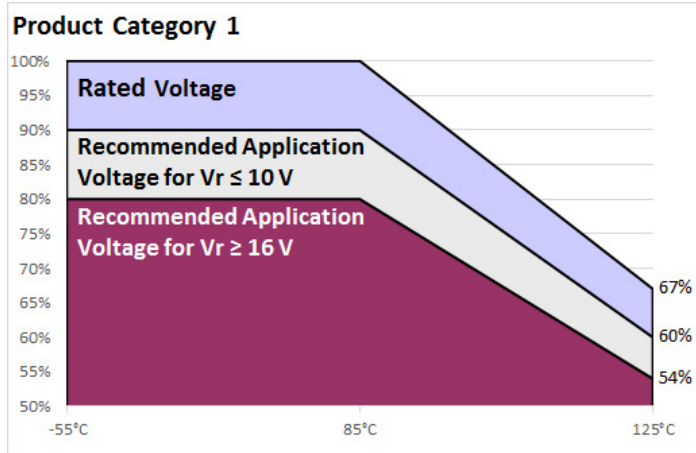

PRODUCT CATEGORY 1 (TEMPERATURE RANGE -55°C TO +125°C)

| TEST | Condition | | | Characteristics | | | | | | | |
|------------------------------|---|---------------|---------------|--------------------|--|-----------|-----------|-----------|------------|-----------|--|
| Endurance | Apply rated voltage (Ur) at 85°C and /or 2/3 rated voltage (Ur) at 125°C for 2000 hours through a circuit impedance of $\leq 0.1\Omega/V$. Stabilize at room temperature for 1-2 hours before measuring. | | | Visual examination | no visible damage | | | | | | |
| | | | | DCL | 1.25 x initial limit | | | | | | |
| | | | | $\Delta C/C$ | within $\pm 20\%$ of initial value | | | | | | |
| | | | | DF | 1.5 x initial limit | | | | | | |
| | | | | ESR | 2 x initial limit | | | | | | |
| Storage Life | Store at 125°C, no voltage applied, for 2000 hours. Stabilize at room temperature for 1-2 hours before measuring. | | | Visual examination | no visible damage | | | | | | |
| | | | | DCL | 2 x initial limit | | | | | | |
| | | | | $\Delta C/C$ | within $\pm 20\%$ of initial value | | | | | | |
| | | | | DF | 1.5 x initial limit | | | | | | |
| | | | | ESR | 2 x initial limit | | | | | | |
| Humidity | Store at 65°C and 95% relative humidity for 500 hours, with no applied voltage. Stabilize at room temperature and humidity for 1-2 hours before measuring. | | | Visual examination | no visible damage | | | | | | |
| | | | | DCL | 3 x initial limit | | | | | | |
| | | | | $\Delta C/C$ | within +30/-20% of initial value | | | | | | |
| | | | | DF | 1.5 x initial limit | | | | | | |
| | | | | ESR | 2 x initial limit | | | | | | |
| Temperature Stability | Step | Temperature°C | Duration(min) | | +20°C | -55°C | +20°C | +85°C | +125°C | +20°C | |
| | 1 | +20 | 15 | | | | | | | | |
| | 2 | -55 | 15 | DCL | IL* | n/a | IL* | 10 x IL* | 12.5 x IL* | IL* | |
| | 3 | +20 | 15 | $\Delta C/C$ | n/a | +0/-20% | $\pm 5\%$ | +20/-0% | +30/-0% | $\pm 5\%$ | |
| | 4 | +85 | 15 | DF | IL* | 1.5 x IL* | IL* | 1.5 x IL* | 2 x IL* | IL* | |
| | 5 | +125 | 15 | | | | | | | | |
| | 6 | +20 | 15 | | | | | | | | |
| Surge Voltage | Apply 1.3x 0.67x rated voltage (Ur) at 125°C for 1000 cycles of duration 6 min (30 sec charge, 5 min 30 sec discharge) through a charge / discharge resistance of 1000 Ω | | | Visual examination | no visible damage | | | | | | |
| | | | | DCL | initial limit | | | | | | |
| | | | | $\Delta C/C$ | within +10/-20% of initial value for Vr $\leq 10V$ within +20/-30% of initial value for Vr $\geq 16V$ | | | | | | |
| | | | | DF | 1.25 x initial limit | | | | | | |
| Mechanical Shock | MIL-STD-202, Method 213, Condition C | | | Visual examination | no visible damage | | | | | | |
| | | | | DCL | initial limit | | | | | | |
| | | | | $\Delta C/C$ | within $\pm 5\%$ of initial value | | | | | | |
| | | | | DF | initial limit | | | | | | |
| | | | | ESR | initial limit | | | | | | |
| Vibration | MIL-STD-202, Method 204, Condition D | | | Visual examination | no visible damage | | | | | | |
| | | | | DCL | initial limit | | | | | | |
| | | | | $\Delta C/C$ | within $\pm 5\%$ of initial value | | | | | | |
| | | | | DF | initial limit | | | | | | |
| | | | | ESR | initial limit | | | | | | |

*Initial Limit

Initial measurement max. 1 hr after the removal from dry pack or after pretreatment at 85°C for 24 hours.

PRODUCT CATEGORY 2, 3 (TEMPERATURE RANGE -55°C TO +105°C)

| TEST | Condition | Characteristics | | | | | | | | |
|------------------------------|--|--------------------|--|--------------|-------|-----------|-----------|-----------|------------|-----------|
| Endurance | Apply rated voltage (Ur) at 85°C for 2000 hours through a circuit impedance of $\leq 0.1\Omega/V$ (all CATEGORIES). And / or apply rated voltage (Ur) (CATEGORY 2) or 0.8x rated voltage (CATEGORY 3) at 105°C for 2000 hours through a circuit impedance of $\leq 0.1\Omega/V$. Always stabilize at room temperature for 1-2 hours before measuring. | Visual examination | no visible damage | | | | | | | |
| | | DCL | 1.25 x initial limit | | | | | | | |
| | | $\Delta C/C$ | within +10/-20% of initial value for $V_r \leq 16V$ within $\pm 20\%$ of initial value for $V_r \geq 20V$ | | | | | | | |
| | | DF | 1.5 x initial limit | | | | | | | |
| | | ESR | 2 x initial limit | | | | | | | |
| Storage Life | Store at 105°C, no voltage applied, for 2000 hours. Stabilize at room temperature for 1-2 hours before measuring. | Visual examination | no visible damage | | | | | | | |
| | | DCL | 1.25 x initial limit | | | | | | | |
| | | $\Delta C/C$ | within +10/-20% of initial value for $V_r \leq 16V$ within $\pm 20\%$ of initial value for $V_r \geq 20V$ | | | | | | | |
| | | DF | 1.5 x initial limit | | | | | | | |
| | | ESR | 2 x initial limit | | | | | | | |
| Humidity | Store at 65°C and 95% relative humidity for 500 hours, with no applied voltage. Stabilize at room temperature and humidity for 1-2 hours before measuring. | Visual examination | no visible damage | | | | | | | |
| | | DCL | 3 x initial limit | | | | | | | |
| | | $\Delta C/C$ | within +30/-20% of initial value | | | | | | | |
| | | DF | 1.5 x initial limit | | | | | | | |
| | | ESR | 2 x initial limit | | | | | | | |
| Temperature Stability | Step | Temperature°C | Duration(min) | | | | | | | |
| | 1 | +20 | 15 | | | | | | | |
| | 2 | -55 | 15 | | | | | | | |
| | 3 | +20 | 15 | | | | | | | |
| | 4 | +85 | 15 | | | | | | | |
| | 5 | +105 | 15 | | | | | | | |
| | 6 | +20 | 15 | | | | | | | |
| | | | | +20°C | -55°C | +20°C | +85°C | +105°C | +20°C | |
| | | | | DCL | IL* | n/a | IL* | 10 x IL* | 12.5 x IL* | IL* |
| | | | | $\Delta C/C$ | n/a | +0/-20% | $\pm 5\%$ | +20/-0% | +30/-0% | $\pm 5\%$ |
| | | | | DF | IL* | 1.5 x IL* | IL* | 1.5 x IL* | 2 x IL* | IL* |
| Surge Voltage | Apply 1.3x rated voltage (Ur) at 105°C for CATEGORY 2, or apply 1.3x 0.8x rated voltage (Ur) at 105°C for CATEGORY 3 for 1000 cycles of duration 6 min (30 sec charge, 5 min 30 sec discharge) through a charge / discharge resistance of 1000 Ω | Visual examination | no visible damage | | | | | | | |
| | | DCL | initial limit | | | | | | | |
| | | $\Delta C/C$ | within +10/-20% of initial value for $V_r \leq 16V$ within +20/-30% of initial value for $V_r \geq 20V$ | | | | | | | |
| | | DF | 1.25 x initial limit | | | | | | | |
| | | ESR | initial limit | | | | | | | |
| Mechanical Shock | MIL-STD-202, Method 213, Condition C | Visual examination | no visible damage | | | | | | | |
| | | DCL | initial limit | | | | | | | |
| | | $\Delta C/C$ | within $\pm 5\%$ of initial value | | | | | | | |
| | | DF | initial limit | | | | | | | |
| | | ESR | initial limit | | | | | | | |
| Vibration | MIL-STD-202, Method 204, Condition D | Visual examination | no visible damage | | | | | | | |
| | | DCL | initial limit | | | | | | | |
| | | $\Delta C/C$ | within $\pm 5\%$ of initial value | | | | | | | |
| | | DF | initial limit | | | | | | | |
| | | ESR | initial limit | | | | | | | |

*Initial Limit

Initial measurement max. 1 hr after the removal from dry pack or after pretreatment at 85°C for 24 hours.

PRODUCT CATEGORY 5 (TEMPERATURE RANGE -55°C TO +85°C)

| TEST | Condition | | | Characteristics | | | | | |
|------------------------------|---|---------------|---------------|--------------------|--|-----------|-----------|-----------|-----------|
| Endurance | Apply rated voltage (Ur) at 85°C for 2000 hours through a circuit impedance of $\leq 0.1\Omega/V$. Stabilize at room temperature for 1-2 hours before measuring. | | | Visual examination | no visible damage | | | | |
| | | | | DCL | 1.25 x initial limit | | | | |
| | | | | $\Delta C/C$ | within +10/-20% of initial value for Vr $\leq 16V$ within $\pm 20\%$ of initial value for Vr $\geq 20V$ | | | | |
| | | | | DF | 1.5 x initial limit | | | | |
| | | | | ESR | 2 x initial limit | | | | |
| Storage Life | Store at 85°C, no voltage applied, for 2000 hours. Stabilize at room temperature for 1-2 hours before measuring. | | | Visual examination | no visible damage | | | | |
| | | | | DCL | 1.25 x initial limit | | | | |
| | | | | $\Delta C/C$ | within +10/-20% of initial value for Vr $\leq 16V$ within $\pm 20\%$ of initial value for Vr $\geq 20V$ | | | | |
| | | | | DF | 1.5 x initial limit | | | | |
| | | | | ESR | 2 x initial limit | | | | |
| Humidity | Store at 65°C and 95% relative humidity for 500 hours, with no applied voltage. Stabilize at room temperature and humidity for 1-2 hours before measuring. | | | Visual examination | no visible damage | | | | |
| | | | | DCL | 5 x initial limit | | | | |
| | | | | $\Delta C/C$ | within +40/-20% of initial value | | | | |
| | | | | DF | 1.5 x initial limit | | | | |
| | | | | ESR | 2 x initial limit | | | | |
| Temperature Stability | Step | Temperature°C | Duration(min) | | +20°C | -55°C | +20°C | +85°C | +20°C |
| | 1 | +20 | 15 | | | | | | |
| | 2 | -55 | 15 | DCL | IL* | n/a | IL* | 10 x IL* | IL* |
| | 3 | +20 | 15 | $\Delta C/C$ | n/a | +0/-20% | $\pm 5\%$ | +20/-0% | $\pm 5\%$ |
| | 4 | +85 | 15 | DF | IL* | 1.5 x IL* | IL* | 1.5 x IL* | IL* |
| | 5 | +20 | 15 | | | | | | |
| Surge Voltage | Apply 1.3x rated voltage (Ur) at 85°C for 1000 cycles of duration 6 min (30 sec charge, 5 min 30 sec discharge) through a charge / discharge resistance of 10000 Ω | | | Visual examination | no visible damage | | | | |
| | | | | DCL | initial limit | | | | |
| | | | | $\Delta C/C$ | within +10/-20% of initial value for Vr $\leq 16V$ within +20/-30% of initial value for Vr $\geq 20V$ | | | | |
| | | | | DF | 1.25 x initial limit | | | | |
| | | | | ESR | initial limit | | | | |
| Mechanical Shock | MIL-STD-202, Method 213, Condition C | | | Visual examination | no visible damage | | | | |
| | | | | DCL | initial limit | | | | |
| | | | | $\Delta C/C$ | within $\pm 5\%$ of initial value | | | | |
| | | | | DF | initial limit | | | | |
| | | | | ESR | initial limit | | | | |
| Vibration | MIL-STD-202, Method 204, Condition D | | | Visual examination | no visible damage | | | | |
| | | | | DCL | initial limit | | | | |
| | | | | $\Delta C/C$ | within $\pm 5\%$ of initial value | | | | |
| | | | | DF | initial limit | | | | |
| | | | | ESR | initial limit | | | | |

*Initial Limit

Initial measurement max. 1hr after the removal from dry pack or after pretreatment at 85°C for 24 hours.

J-CAP™ Series

Highest Joules/cc Conductive Polymer Solid Electrolytic Chip Capacitors



SOLID ELECTROLYTIC CAPACITOR ROADMAP

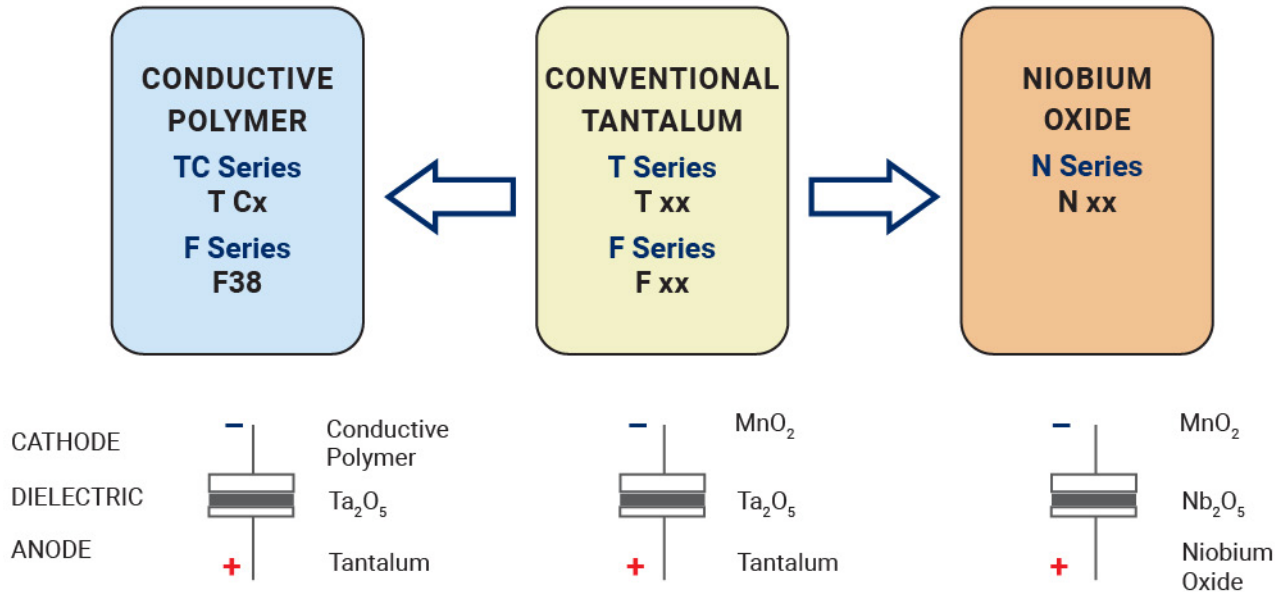

FIVE CAPACITOR CONSTRUCTION STYLES

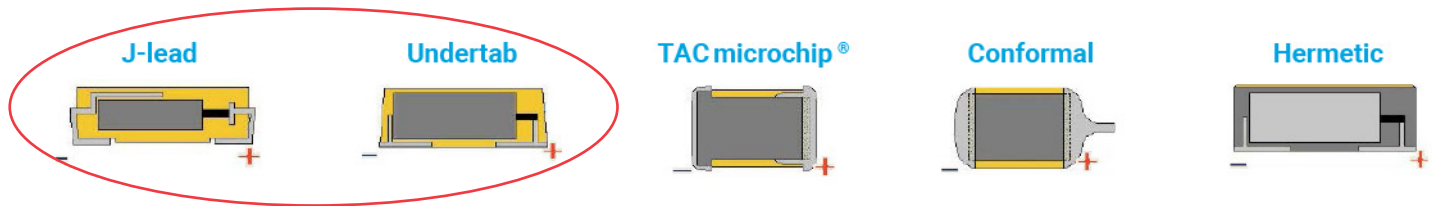

SERIES LINE UP : Conductive Polymer

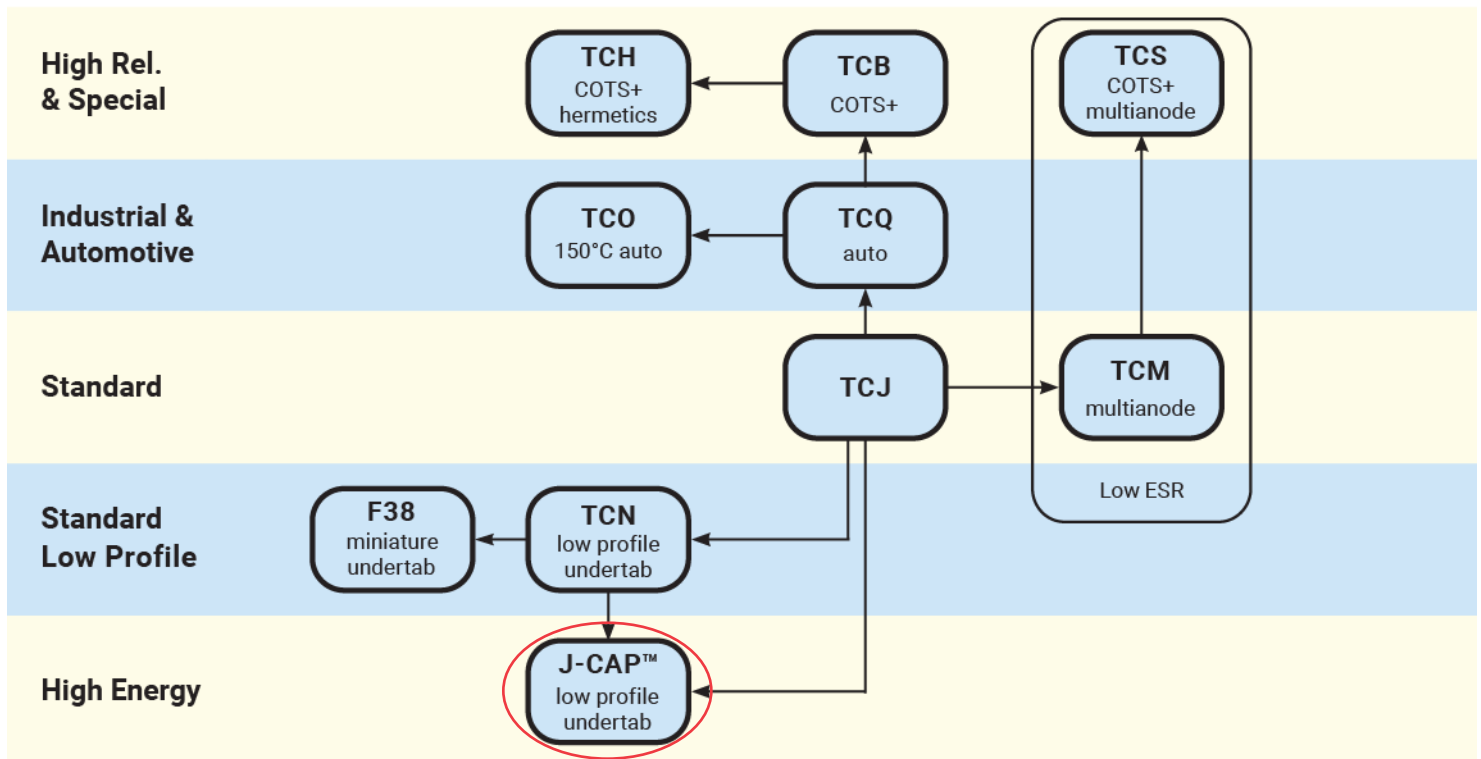

The Important Information/Disclaimer is incorporated in the catalog where these specifications came from or available online at www.avx.com/disclaimer/ by reference and should be reviewed in full before placing any order.