

PROTECTION

FPX (FPY RoHS Compliant)

PROTECTION



PROTECTION

Plastic Case Style M6 / 6 or M8 / 8

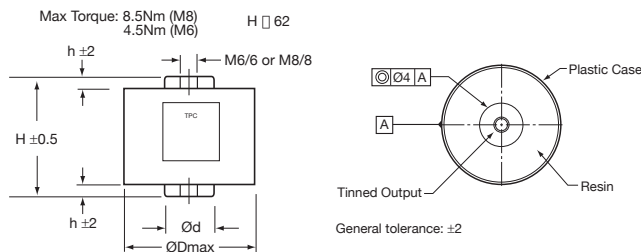

Plastic Case Style M8 / 10

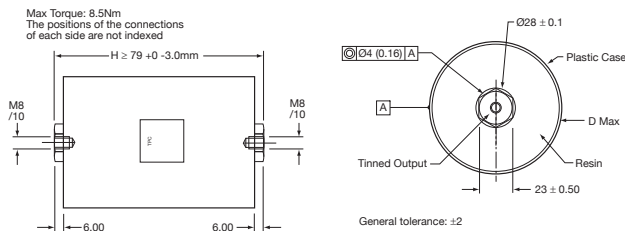

MARKING

- Logo
- Withstanding surge voltage
- Capacitance and tolerance in clear
- Nominal DC voltage in clear
- RMS current in clear
- Date of manufacture (IEC coding)

HOW TO ORDER

FPX	6	6	N	0154	J	--
Series FPX = Standard FPY = RoHS Compliant	Case Size Case Size 6 Case Size 8 (See Case Style)	Dielectric 6 = Polypropylene	Voltage Code N = 2000V P = 2500V X = 3500V Z = 4500V Y = 4600V	Capacitance Code 0 + pF code 0105 = 1.0µF 0335 = 3.5µF 0504 = 0.5µF etc.	Capacitance Tolerances J = ± 5%	Terminal Code -- = Standard

Not RoHS Compliant



APPLICATIONS

- Protection of Thyristors
- Protection of Gate Turn-off Thyristor (G.T.O.)
- Clamping (Secondary Snubber)

TECHNOLOGY

Metallized polypropylene dielectric capacitor with controlled self-healing.

Reinforced metallization developed for high impulse currents.

Axial connections specially developed to reduce series inductance and to provide rigid mechanical mounting.

PACKAGING MATERIAL

Cylindrical in plastic case filled with thermosetting resin. Outputs: threaded inserts either M6 or M8.

HOT SPOT TEMPERATURE CALCULATION

See *Hot Spot Temperature*, page 3.

$$\theta_{\text{hot spot}} = \theta_{\text{ambient}} + (P_d + P_t) \times R_{th}$$

with

$$P_d \text{ (Dielectric losses)} = Q \times \text{tg} \delta_0$$

$$\Rightarrow \left[\frac{1}{2} \times C_n \times (V_{\text{peak to peak}})^2 \times f \right] \times (2 \times 10^{-4})$$

$$P_t \text{ (Thermal losses)} = R_s \times (I_{\text{rms}})^2$$

where

C_n in Farads

V in Volts

I_{rms} in Amperes

R_s in Ohms

f in Hertz

θ in °C

R_{th} in °C/W

Due to the design of the capacitor and its technology, the thermal impedance between the terminations and the core of the capacitor is low, it is necessary to take care that the capacitor is never overheated by use of incorrect sized connections.

In the case where the series diodes are screwed to the capacitor, cooling of the diodes must be taken in account.

Do not use the capacitor as a heat sink.

Due to the complexity of the diode/capacitor thermal exchanges, we recommend that thermal measurements shall be made on the different components. We would be pleased to advise you on specific problems.

WORKING TEMPERATURE

(according to the power to be dissipated)

-40°C to +85°C

PROTECTION

FPX (FPY RoHS Compliant)

ELECTRICAL CHARACTERISTICS

Capacitance range C_n	0.5 μ F to 6 μ F
Tolerance on C_n	\pm 5%
Rated DC voltage $V_{n,dc}$	1000 to 3000 V
Peak voltage V_{peak}	1600 to 4000 V
Allowable overvoltage V_s (for 10 s/day)	2000 to 4600 V
Stray inductance	5 to 20 nH
RMS current	I_{rms} max. = up to 160 A The currents shown in the tables are maximum. It is necessary to respect the thermal limits of the dielectric 85°C see "Hot spot temperature calculation"
Insulation resistance	$R_i \times C \geq 30,000$ s
Impulse current	$I^2.t$ maxi. = up to 729 A ² .s Spikes or peak currents in the capacitors may cause a deterioration of the bonding between the metallization and the connections. These bonds are capable of withstanding only a limited amount of energy for each spike. The table shows the maximum energy permitted in the form ($I^2.t$), where I is in Ampere, and t is in seconds.
Note: The formula ($I^2.t$) replaces dV/dt which is less easy to use as it is not an expression of energy ($I = C.dV/dt$). This type of capacitor has been designed to withstand high ($I^2.t$) values.	
Variation of capacitance with temperature	$\frac{\Delta C}{C} \leq \pm 2\%$ between -40 and +85°C
Climatic category	40/085/56 (IEC 60068)
Test voltage between terminals @ 25°C	V_s for 10s
Test voltage between terminals and case @ 25°C (Type test)	@ 7 kV _{rms} @ 50 Hz for 1 min.
Dielectric	Polypropylene

PROTECTION

FPX (FPY RoHS Compliant) Table of Values

PROTECTION

Part Number	Cn (µF)	Dimensions					I ² t max. (A ² .s)	I _{rms} max. (A)	R _s (mΩ)	Rth (°C/W)	Typical Weight (g)
		Case Style	H* ±0.5 (mm)	h ±2 (mm)	D max. (mm)	d ±0.5 (mm)					
FPX 2000V V_{n,dc} = 1000V V_{peak} = 1600V V_{rms} = 560V V_s = 2000V (Voltage Code N)											
FPX66N0105J-	1	Plastic case M6/6	52	5	40	18	2	15	2.4	14)	120
FPX86N0205J-	2	Plastic case M8/8	52	5	60	22	8	30	1.2	6.1	190
FPX86N0305J-	3	Plastic case M8/8	52	5	72	22	18	45	0.9	4.5	260
FPX86N0355J-	3.5	Plastic case M8/8	52	5	72	22	25	50	0.85	4.5	260
FPX86N0405J-	4	Plastic case M8/8	52	5	82	22	32	60	0.75	3.5	320
FPX86N0505J-	5	Plastic case M8/8	52	5	82	22	50	70	0.65	2.5	320
FPX 2500V V_{n,dc} = 1300V V_{peak} = 2000V V_{rms} = 700V V_s = 2500V (Voltage Code P)											
FPX66P0504J-	0.5	Plastic case M6/6	52	5	40	18	1	15	3	14	120
FPX86P0105J-	1	Plastic case M8/8	52	5	60	22	3	20	2.3	10.5	190
FPX86P0155J-	1.5	Plastic case M8/8	52	5	60	22	7	30	1.5	6.1	190
FPX86P0205J-	2	Plastic case M8/8	52	5	72	22	12.7	40	1.1	4.5	260
FPX86P0255J-	2.5	Plastic case M8/8	52	5	72	22	20	60	0.89	3.7	260
FPX86P0305J-	3	Plastic case M8/8	52	5	82	22	28	60	0.85	3.2	320
FPX86P0355J-	3.5	Plastic case M8/8	52	5	82	22	39	65	0.78	2.9	320
FPX 3500V V_{n,dc} = 2000V V_{peak} = 2400V V_{rms} = 850V V_s = 3500V (Voltage Code X)											
FPX86X0205J-	2	Plastic case M8/8	62	5	72	22	23	41	1.24	6.1	310
FPX86X0305J-	3	Plastic case M8/8	62	5	92	22	50	62	0.92	3.9	475
FPX86X0355J-	3.5	Plastic case M8/8	62	5	92	22	70	72	0.83	3.4	475
FPX86X0405J-	4	Plastic case M8/8	62	5	92	22	85	80	0.78	3.1	475
FPX 4500V V_{n,dc} = 2500V V_{peak} = 3200V V_{rms} = 1130V V_s = 4500V (Voltage Code Z)											
FPX86Z0904J-	0.9	Plastic case M8/8	62	5	72	22	15	40	1.5	6.2	310
FPX86Z0105J-	1	Plastic case M8/8	62	5	72	22	15	38	1.4	6.2	310
FPX86Z0205J-	2	Plastic case M8/8	62	5	92	22	70	75	0.85	3.1	475
FPX 4600V V_{n,dc} = 3000V V_{peak} = 4000V V_{rms} = 1400V V_s = 4600V (Voltage Code Y)											
FPX86Y0504J-	0.5	Plastic case M8/8	62	5	72	22	7	40	1.7	12	310
FPX86Y0684J-	0.68	Plastic case M8/8	62	5	72	22	14	35	1.59	6.2	310
FPX86Y1254J-	1.25	Plastic case M8/8	62	5	92	22	50	65	1	3.3	475
FPX86Y0155J-	1.5	Plastic case M8/10	79	6	98	-	32	60	1.4	8.3	630
FPX86Y0175J-	1.7	Plastic case M8/10	79	6	98	-	40	70	1.3	7.4	630
FPX86Y0205J-	2	Plastic case M8/10	79	6	98	-	56	80	1.1	6.3	630
FPX86Y0255J-	2.5	Plastic case M8/10	118	6	98	-	200	130	0.8	1.1	1020
FPX86Y0275J-	2.7	Plastic case M8/10	118	6	98	-	232	140	0.7	1.1	1020
FPX86Y0305J-	3	Plastic case M8/10	143	6	98	-	128	100	0.9	1.5	1280
FPX86Y0355J-	3.5	Plastic case M8/10	143	6	98	-	170	110	0.8	1.4	1280
FPX86Y0405J-	4	Plastic case M8/10	143	6	98	-	224	115	0.8	1.4	1280
FPX86Y0455J-	4.5	Plastic case M8/10	163	6	98	-	522	120	0.6	1.7	1500
FPX86Y0505J-	5	Plastic case M8/10	163	6	98	-	600	130	0.6	1.7	1500
FPX86Y0605J-	6	Plastic case M8/10	163	6	98	-	729	160	0.5	1.7	1500

* Tol: +0 / -3mm for H ≥ 118mm

PROTECTION

FPX (FPY RoHS Compliant) General / Application Notes

PROTECTION

G.T.O.

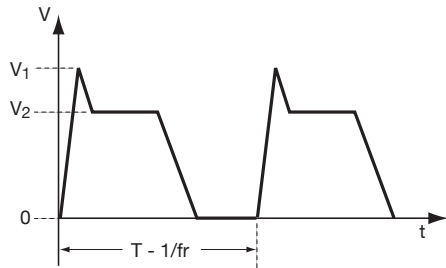

Choice of voltage: $V_1 \leq V_{peak}$
 $V_2 \leq V_{n,dc}$

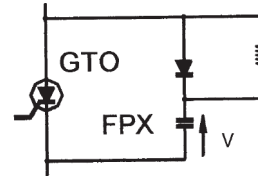

Nominal DC voltage ($V_{n,dc}$) and peak voltage (V_{peak}) are given in the tables.

THYRISTOR

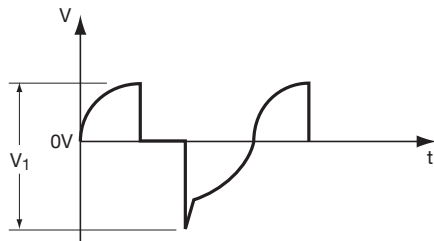

Choice of voltage: $V_1 \leq V_{peak}$

Note that V_1 is the voltage peak to peak and cannot be symmetrical vs 0 V

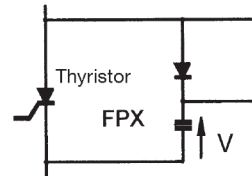

Peak voltage is given in the tables.

CLAMPING

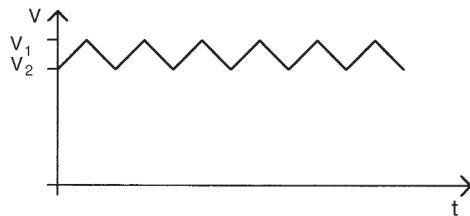

Choice of voltage: $V_1 \leq V_{peak}$
 $V_2 \leq V_{n,dc}$

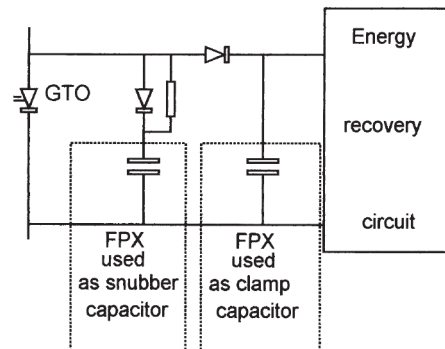

Nominal DC voltage ($V_{n,dc}$) and peak voltage (V_{peak}) are given in the tables.