

# CERAFIL® (Filters/Traps/Discriminators) for Audio/Visual Equipment



## CERAFIL® 10.7MHz Small Chip Type SF ECS Series

SF ECS10M7 series for FM-receivers are small, high performance and super thin (1.5mm max.) filters.

Piezoelectric element is connected in the sandwich shape by ceramics substrate.

They have 1.5mm max. thickness and small mounting area. (3.45x3.1mm)

SF ECS series and PFWCC (kHz filter for AM receiver) enable customers to make AM/FM set so thin and small sized.

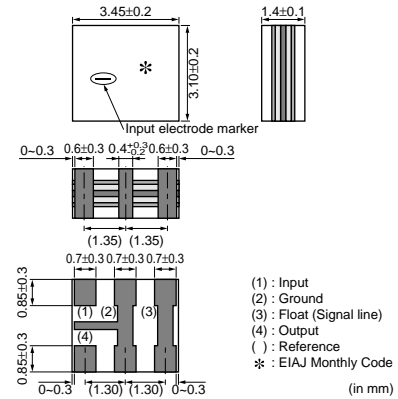
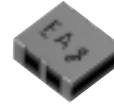

### ■ Features

1. The filters are mountable by automatic placers.
2. They are slim, at only 1.5mm max. thickness, and have a small mounting area (3.45x3.1mm) enabling flexible PCB design.
3. Various bandwidths are available. Select a suitable type in accordance with the desired selectivity.
4. Operating temperature range :  
-20 to +80 (degree C)  
Storage temperature range :  
-40 to +85 (degree C)

### ■ Applications

1. Small, thin radios
2. Headphone stereos

Part Number	Center Frequency (fo) (MHz)	Nominal Center Frequency (fn) (MHz)	3dB Bandwidth (kHz)	Attenuation (kHz)	Insertion Loss (dB)	Spurious Attenuation (dB)	Input/Output Impedance (ohm)
SF ECS10M7HA00-R0	10.700 ±30kHz	-	180 ±40kHz	470 max.	4.5 ±2.0dB	30 min.	330
SF ECS10M7GA00-R0	10.700 ±30kHz	-	230 ±50kHz	510 max.	3.5 ±2.0dB	30 min.	330
SF ECS10M7FA00-R0	10.700 ±30kHz	-	280 ±50kHz	590 max.	3.0 ±2.0dB	30 min.	330
SF ECS10M7EA00-R0	10.700 ±30kHz	-	330 ±50kHz	700 max.	3.0 ±2.0dB	30 min.	330
SF ECS10M7DF0021-R0	-	10.700	fn ±200kHz min.	950 max.	3.0 ±2.0dB	20 min.	330

Attenuation Bandwidth : at 20dB loss point Area of Spurious Attenuation : [within 9MHz to 12MHz]

Insertion Loss: at minimum loss point

Center frequency (fo) defined by the center of 3dB bandwidth.

The order quantity should be an integral multiple of the "Minimum Quantity" shown in the package page.

### ■ Standard Center Frequency Rank Code

CODE	30kHz Step	25kHz Step
D	10.64MHz±30kHz	10.650MHz±25kHz
B	10.67MHz±30kHz	10.675MHz±25kHz
A	10.70MHz±30kHz	10.700MHz±25kHz
C	10.73MHz±30kHz	10.725MHz±25kHz
E	10.76MHz±30kHz	10.750MHz±25kHz
Z	Combination A,B,C,D,E	
M	Combination A,B,C	

Continued on the following page. ↗

↳ Continued from the preceding page.

■ Standard Land Pattern Dimensions

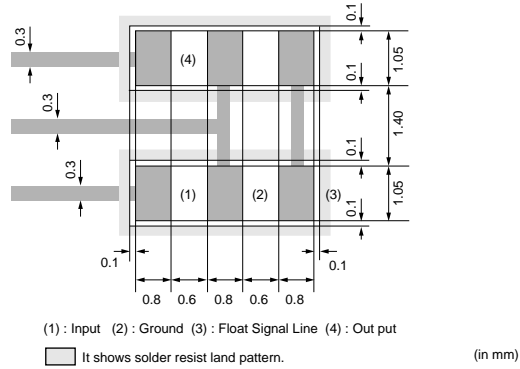

■ Test Circuit

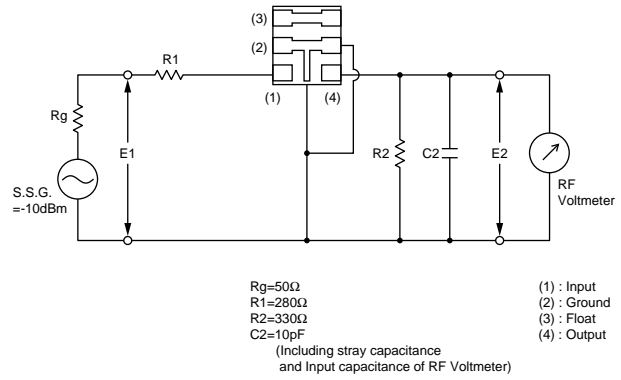

1

■ Frequency Characteristics

SF ECS10M7HA00-R0

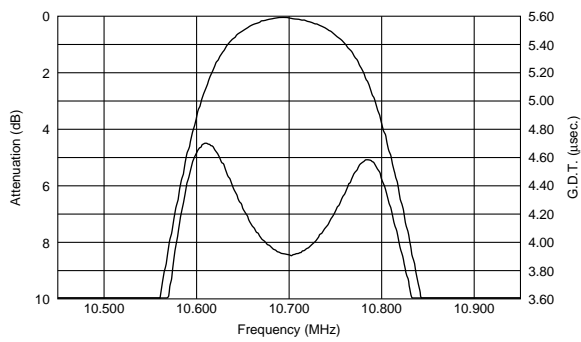

SF ECS10M7GA00-R0

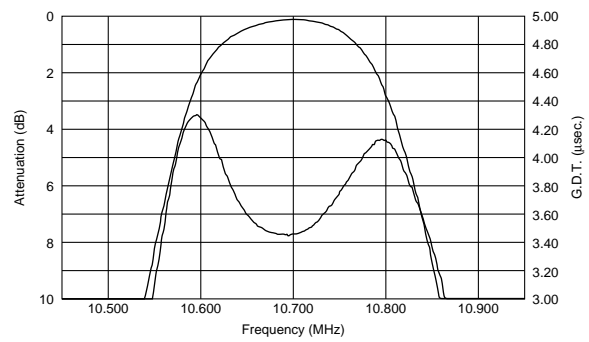

SF ECS10M7FA00-R0

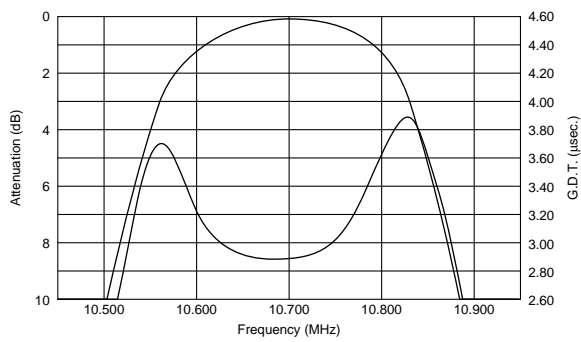

■ Frequency Characteristics (Spurious)

SF ECS10M7HA00-R0

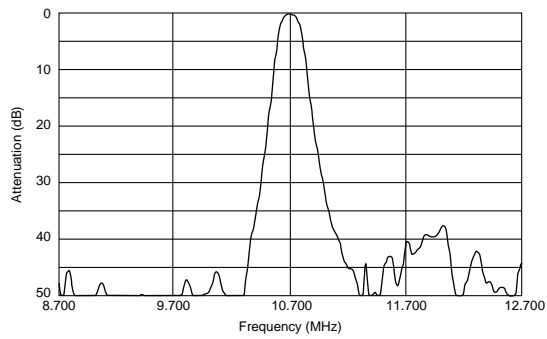

SF ECS10M7GA00-R0

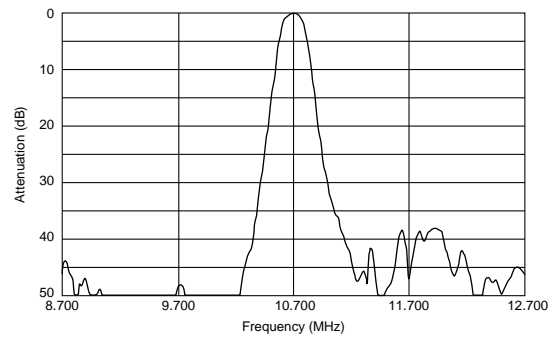

Continued on the following page. ↗

⚠Note Please read rating and ⚠CAUTION (for storage, operating, rating, soldering, mounting and handling) in this PDF catalog to prevent smoking and/or burning, etc.  
This catalog has only typical specifications. Therefore, you are requested to approve our product specifications or to transact the approval sheet for product specifications before ordering.

P50E.pdf 03.4.16

↳ Continued from the preceding page.

1

## ■ Frequency Characteristics (Spurious)

SFECS10M7FA00-R0

