

SiGe HBT GAIN BLOCK MMIC AMPLIFIER, DC - 5 GHz



Typical Applications

The HMC481ST89 / HMC481ST89E is an ideal RF/IF gain block & LO or PA driver for:

- Cellular / PCS / 3G
- Fixed Wireless & WLAN
- CATV, Cable Modem & DBS
- Microwave Radio & Test Equipment

Features

- P1dB Output Power: +19 dBm
- Gain: 20 dB
- Output IP3: +33 dBm
- Cascadable 50 Ohm I/Os
- Single Supply: +6V to +12V
- Industry Standard SOT89 Package
- Included in the HMC-DK001 Designer's Kits

Functional Diagram

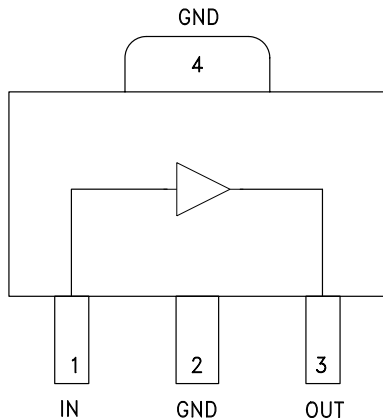

General Description

The HMC481ST89 & HMC481ST89E are SiGe Heterojunction Bipolar Transistor (HBT) Gain Block MMIC SMT amplifiers covering DC to 5 GHz. Packaged in an industry standard SOT89, the amplifier can be used as a cascadable 50 Ohm RF/IF gain stage as well as a LO or PA driver with up to +21 dBm output power. The HMC481ST89(E) offer 20 dB of gain with a +33 dBm output IP3 at 1 GHz while requiring only 79 mA from a single positive supply. The Darlington feedback pair used results in reduced sensitivity to normal process variations and excellent gain stability over temperature while requiring a minimal number of external bias components.

Electrical Specifications, $V_s = 8.0\text{ V}$, $R_{bias} = 39\text{ Ohm}$, $T_A = +25^\circ\text{ C}$

Parameter	Min.	Typ.	Max.	Units	
Gain	DC - 1.0 GHz	18	20	dB	
	1.0 - 2.0 GHz	15.5	17.5	dB	
	2.0 - 3.0 GHz	13	15	dB	
	3.0 - 4.0 GHz	11	13	dB	
	4.0 - 5.0 GHz	9	11	dB	
Gain Variation Over Temperature	DC - 5 GHz		0.008	0.016	dB/ °C
Input Return Loss	DC - 1.0 GHz		12		dB
	1.0 - 5.0 GHz		15		dB
Output Return Loss	DC - 1.0 GHz		17		dB
	1.0 - 4.0 GHz		27		dB
	4.0 - 5.0 GHz		23		dB
Reverse Isolation	DC - 5 GHz		18		dB
Output Power for 1 dB Compression (P1dB)	0.5 - 1.0 GHz	16	19		dBm
	1.0 - 2.0 GHz	15	18		dBm
	2.0 - 3.0 GHz	13	16		dBm
	3.0 - 4.0 GHz	11	14		dBm
	4.0 - 5.0 GHz	9	12		dBm
Output Third Order Intercept (IP3) (Pout= 0 dBm per tone, 1 MHz spacing)	0.5 - 2.0 GHz		33		dBm
	2.0 - 3.0 GHz		30		dBm
	3.0 - 4.0 GHz		27		dBm
	4.0 - 5.0 GHz		25		dBm
Noise Figure	DC - 4 GHz		3.5		dB
	4.0 - 5.0 GHz		4.0		dB
Supply Current (Icq)			79		mA

Note: Data taken with broadband bias tee on device output.

Information furnished by Analog Devices is believed to be accurate and reliable. However, no responsibility is assumed by Analog Devices for its use, nor for any infringements of patents or other rights of third parties that may result from its use. Specifications subject to change without notice. No license is granted by implication or otherwise under any patent or patent rights of Analog Devices. Trademarks and registered trademarks are the property of their respective owners.

For price, delivery, and to place orders: Analog Devices, Inc., One Technology Way, P.O. Box 9106, Norwood, MA 02062-9106
Phone: 781-329-4700 • Order online at www.analog.com
Application Support: Phone: 1-800-ANALOG-D



**SiGe HBT GAIN BLOCK
MMIC AMPLIFIER, DC - 5 GHz**

Broadband Gain & Return Loss

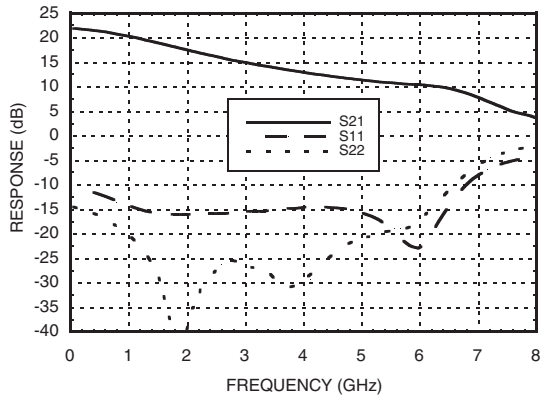

Gain vs. Temperature

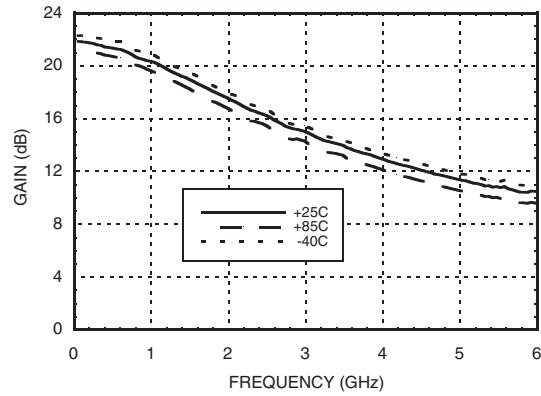

Input Return Loss vs. Temperature

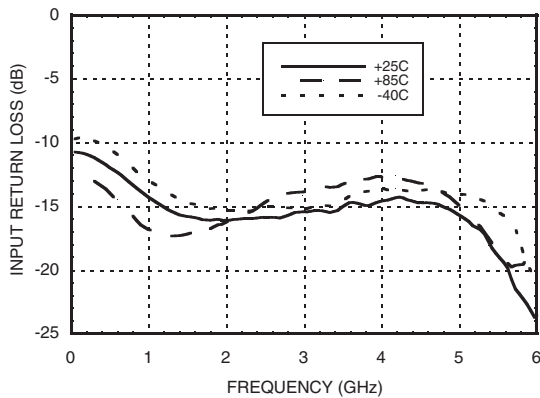

Output Return Loss vs. Temperature

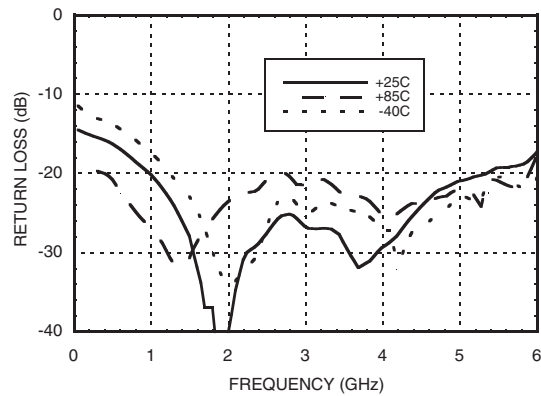

Reverse Isolation vs. Temperature

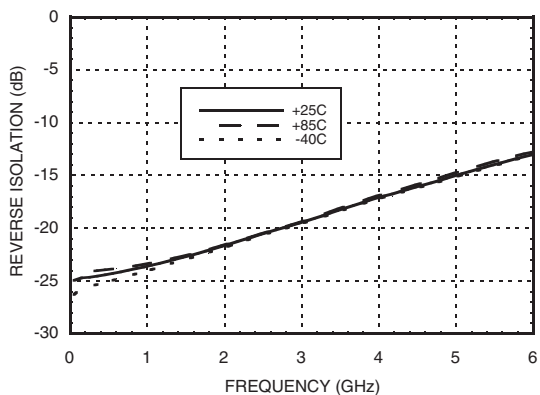

Noise Figure vs. Temperature

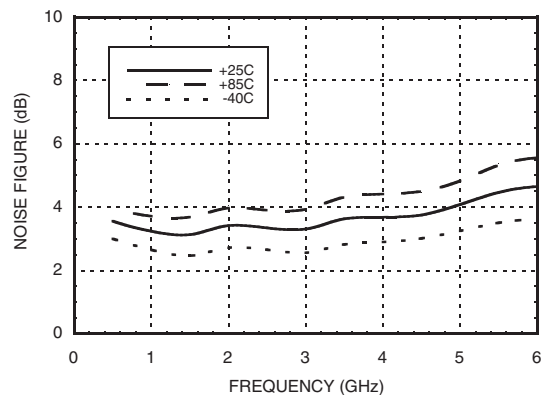

Information furnished by Analog Devices is believed to be accurate and reliable. However, no responsibility is assumed by Analog Devices for its use, nor for any infringements of patents or other rights of third parties that may result from its use. Specifications subject to change without notice. No license is granted by implication or otherwise under any patent or patent rights of Analog Devices. Trademarks and registered trademarks are the property of their respective owners.

For price, delivery, and to place orders: Analog Devices, Inc., One Technology Way, P.O. Box 9106, Norwood, MA 02062-9106 Phone: 781-329-4700 • Order online at www.analog.com Application Support: Phone: 1-800-ANALOG-D



**SiGe HBT GAIN BLOCK
MMIC AMPLIFIER, DC - 5 GHz**

P1dB vs. Temperature

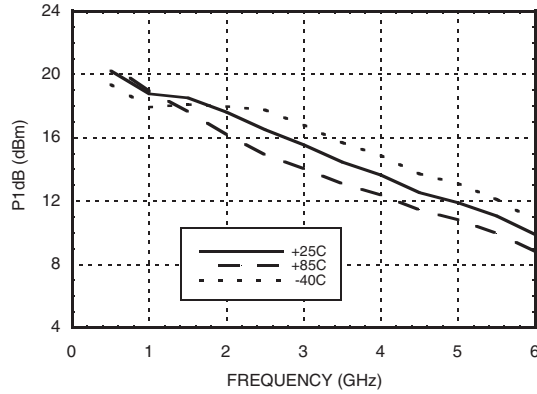

Psat vs. Temperature

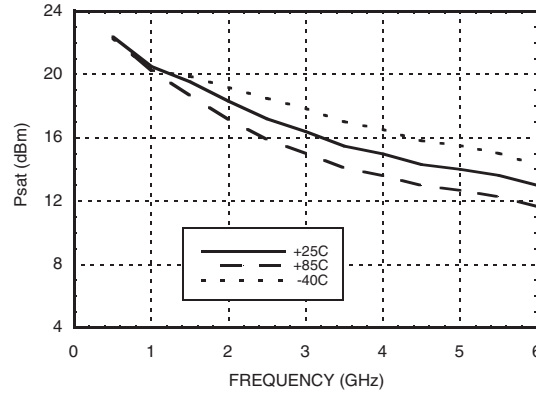

Output IP3 vs. Temperature

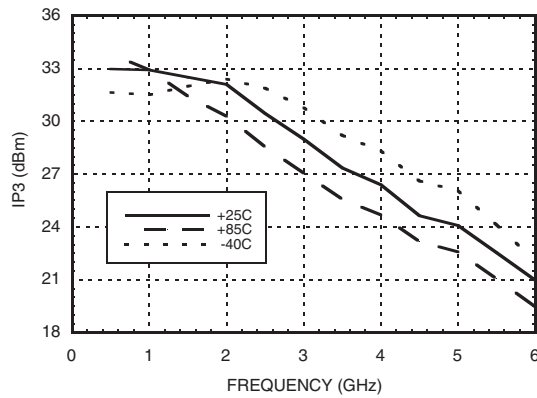

Gain, Power & OIP3 vs. Supply Voltage for Constant Icc= 79 mA @ 850 MHz

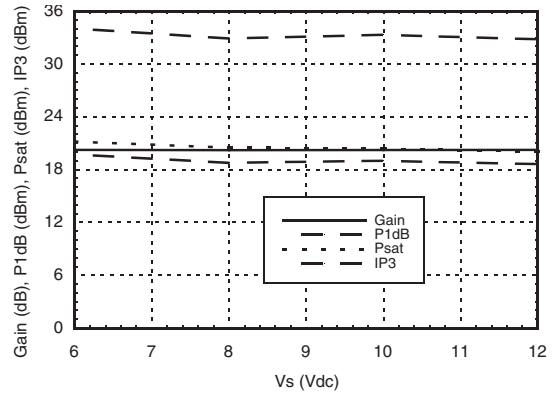

Vcc vs. Icc Over Temperature for Fixed Vs= 8V, RBIAS= 39 Ohms

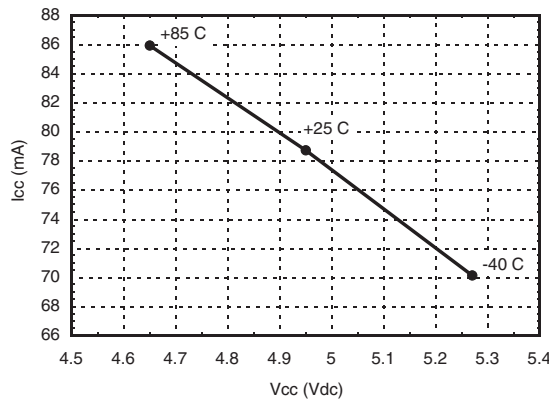

Information furnished by Analog Devices is believed to be accurate and reliable. However, no responsibility is assumed by Analog Devices for its use, nor for any infringements of patents or other rights of third parties that may result from its use. Specifications subject to change without notice. No license is granted by implication or otherwise under any patent or patent rights of Analog Devices. Trademarks and registered trademarks are the property of their respective owners.

For price, delivery, and to place orders: Analog Devices, Inc., One Technology Way, P.O. Box 9106, Norwood, MA 02062-9106 Phone: 781-329-4700 • Order online at www.analog.com Application Support: Phone: 1-800-ANALOG-D



SiGe HBT GAIN BLOCK MMIC AMPLIFIER, DC - 5 GHz

Absolute Maximum Ratings

Collector Bias Voltage (Vcc)	+6.0 Vdc
RF Input Power (RFIN)(Vcc = +5 Vdc)	+10 dBm
Junction Temperature	150 °C
Continuous P _{diss} (T = 85 °C) (derate 16.3 mW/°C above 85 °C)	1.06 W
Thermal Resistance (junction to lead)	61.4 °C/W
Storage Temperature	-65 to +150 °C
Operating Temperature	-40 to +85 °C
ESD Sensitivity (HBM)	Class 1A



ELECTROSTATIC SENSITIVE DEVICE
OBSERVE HANDLING PRECAUTIONS

Outline Drawing

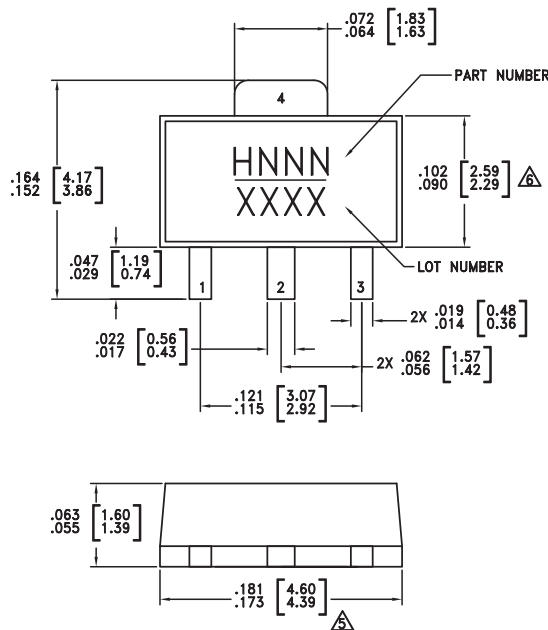

NOTES:

- PACKAGE BODY MATERIAL:
MOLDING COMPOUND MP-180S OR EQUIVALENT.
- LEAD MATERIAL: Cu w/ Ag SPOT PLATING.
- LEAD PLATING: 100% MATTE TIN.
- DIMENSIONS ARE IN INCHES [MILLIMETERS]
- △ DIMENSION DOES NOT INCLUDE MOLDFLASH OF 0.15mm PER SIDE.
- △ DIMENSION DOES NOT INCLUDE MOLDFLASH OF 0.25mm PER SIDE.
- ALL GROUND LEADS MUST BE SOLDERED TO PCB RF GROUND.

Package Information

Part Number	Package Body Material	Lead Finish	MSL Rating	Package Marking ^[3]
HMC481ST89	Low Stress Injection Molded Plastic	Sn/Pb Solder	MSL1 ^[1]	H481 XXXX
HMC481ST89E	RoHS-compliant Low Stress Injection Molded Plastic	100% matte Sn	MSL1 ^[2]	H481 XXXX

[1] Max peak reflow temperature of 235 °C

[2] Max peak reflow temperature of 260 °C

[3] 4-Digit lot number XXXX

Information furnished by Analog Devices is believed to be accurate and reliable. However, no responsibility is assumed by Analog Devices for its use, nor for any infringements of patents or other rights of third parties that may result from its use. Specifications subject to change without notice. No license is granted by implication or otherwise under any patent or patent rights of Analog Devices. Trademarks and registered trademarks are the property of their respective owners.

For price, delivery, and to place orders: Analog Devices, Inc., One Technology Way, P.O. Box 9106, Norwood, MA 02062-9106
Phone: 781-329-4700 • Order online at www.analog.com
Application Support: Phone: 1-800-ANALOG-D

SiGe HBT GAIN BLOCK MMIC AMPLIFIER, DC - 5 GHz



Pin Descriptions

Pin Number	Function	Description	Interface Schematic
1	RFIN	This pin is DC coupled. An off chip DC blocking capacitor is required.	
3	RFOUT	RF output and DC Bias (Vcc) for the output stage.	
2, 4	GND	These pins and package bottom must be connected to RF/DC ground.	

Application Circuit

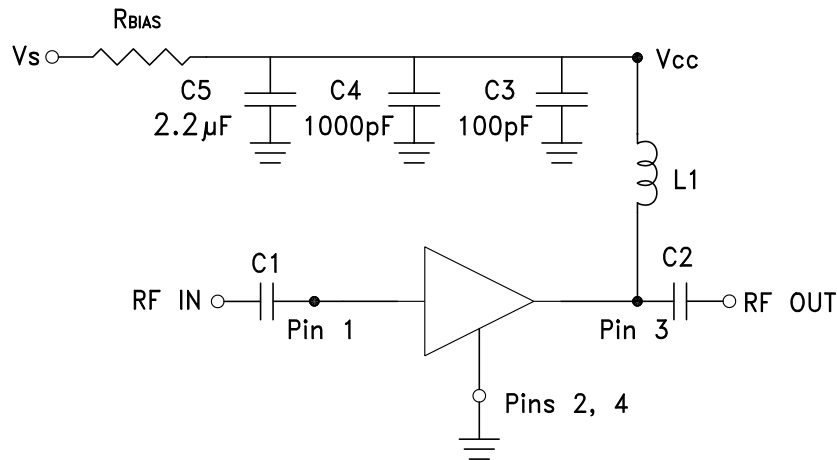

Recommended Bias Resistor Values for $I_{cc} = 79 \text{ mA}$, $R_{bias} = (V_s - V_{cc}) / I_{cc}$

Supply Voltage (Vs)	6V	8V	10V	12V
RBIAS VALUE	11 Ω	39 Ω	62 Ω	91 Ω
RBIAS POWER RATING	1/8 W	1/4 W	1/2 W	1 W

Note:

- External blocking capacitors are required on RFIN and RFOUT.
- RBIAS provides DC bias stability over temperature.

Recommended Component Values for Key Application Frequencies

Component	Frequency (MHz)						
	50	900	1900	2200	2400	3500	5000
L1	270 nH	56 nH	18 nH	18 nH	15 nH	8.2 nH	6.8 nH
C1, C2	0.01 μF	100 pF	100 pF	100 pF	100 pF	100 pF	100 pF

Information furnished by Analog Devices is believed to be accurate and reliable. However, no responsibility is assumed by Analog Devices for its use, nor for any infringements of patents or other rights of third parties that may result from its use. Specifications subject to change without notice. No license is granted by implication or otherwise under any patent or patent rights of Analog Devices. Trademarks and registered trademarks are the property of their respective owners.

For price, delivery, and to place orders: Analog Devices, Inc., One Technology Way, P.O. Box 9106, Norwood, MA 02062-9106
Phone: 781-329-4700 • Order online at www.analog.com
Application Support: Phone: 1-800-ANALOG-D



**SiGe HBT GAIN BLOCK
MMIC AMPLIFIER, DC - 5 GHz**

Evaluation PCB

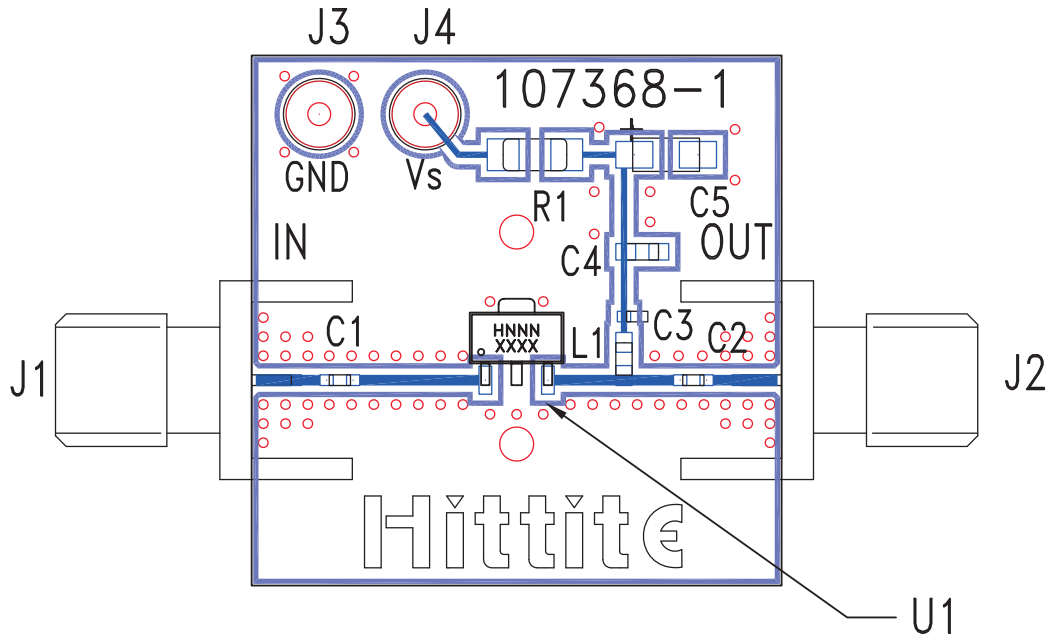

List of Materials for Evaluation PCB 108324 [1]

Item	Description
J1 - J2	PCB Mount SMA Connector
J3 - J4	DC Pin
C1, C2	Capacitor, 0402 Pkg.
C3	100 pF Capacitor, 0402 Pkg.
C4	1000 pF Capacitor, 0603 Pkg.
C5	2.2 μ F Capacitor, Tantalum
R1	Resistor, 1210 Pkg.
L1	Inductor, 0603 Pkg.
U1	HMC481ST89 / HMC481ST89E
PCB [2]	107368 Evaluation PCB

[1] Reference this number when ordering complete evaluation PCB

[2] Circuit Board Material: Rogers 4350

The circuit board used in the final application should use RF circuit design techniques. Signal lines should have 50 Ohm impedance while the package ground leads and package bottom should be connected directly to the ground plane similar to that shown. A sufficient number of via holes should be used to connect the top and bottom ground planes. The evaluation board should be mounted to an appropriate heat sink. The evaluation circuit board shown is available from Hittite upon request.