

C1608X5R2A332M080AA

TDK Item Description : C1608X5R2A332MT****



Application & Main Feature

Commercial Grade (Mid Voltage (100 to 630V))

Series

C1608 [EIA CC0603]

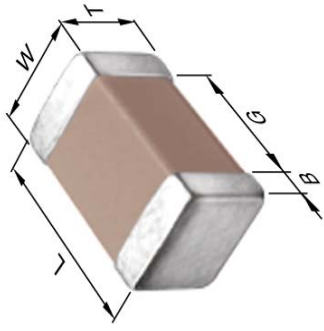

DC Bias Characteristic

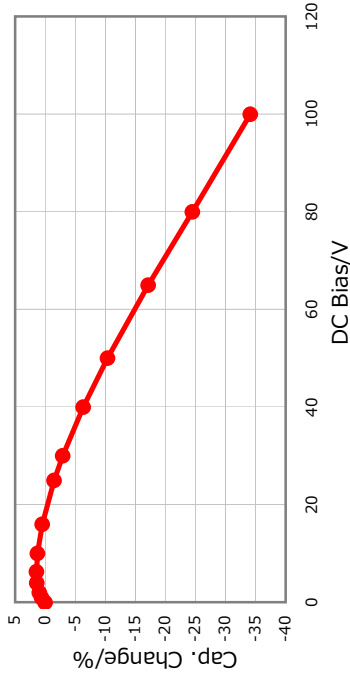

|Z|, ESR vs. Freq. Characteristics

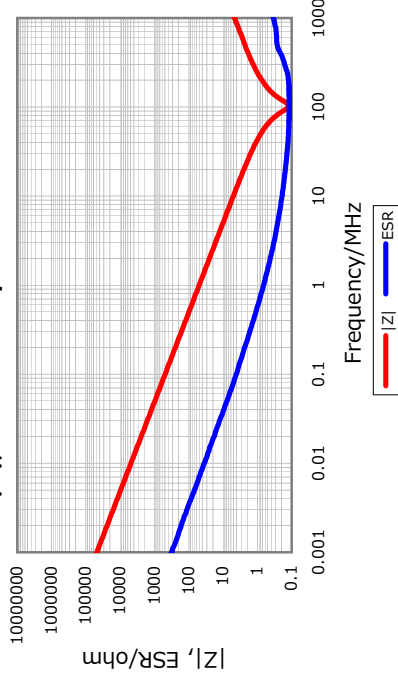

Cap. vs. Freq. Characteristic

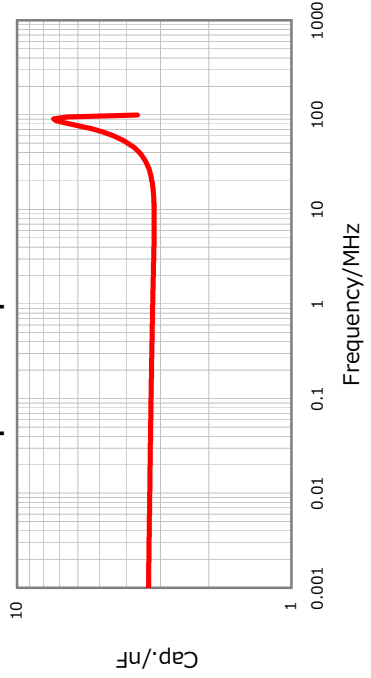

Temperature Characteristics

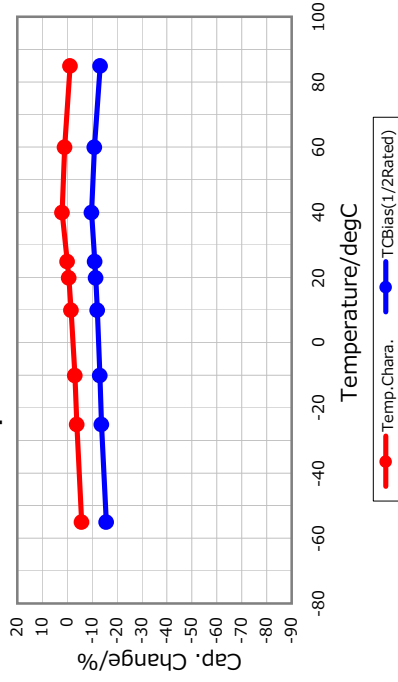

Ripple Temperature Rise Characteristics

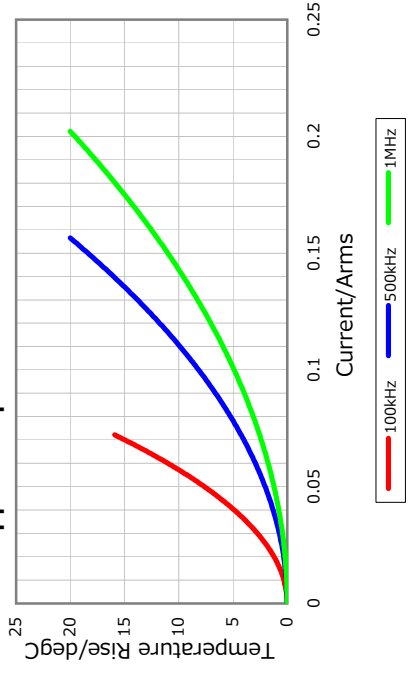

Dimensions

- L 1.60mm +/-0.1mm
- W 0.80mm +/-0.1mm
- T 0.80mm +/-0.1mm
- B 0.20mm Min.
- G 0.30mm Min.

Temperature Characteristic

X5R (-55 to 85 degC +/-15%)

Rated Voltage

2A (100Vdc)

Capacitance

3.3nF

Capacitance Tolerance

M (+/-20%)

Dissipation Factor

3% Max.

Insulation Resistance

10Gohm Min.

AEC-Q200

Not Applicable



All specifications are subject to change without notice.

January 3, 2016