

EKMB (WL) series

Current consumption **1/2/6μA** Digital output



Standard detection type



Long distance detection type

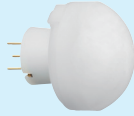

Wall installation type

- Low current consumption for battery-driven applications
- A special differential input circuit design (EKMB 6μA type only) for applications where a high noise resistance is required (up to GHz range).



Recommended applications

IoT, occupancy sensor module for smart home, battery-driven applications, wireless devices

Lensless type available

1μA type: EKMB1100100 6μA type: EKMB1300100K
2μA type: EKMB1200100

Specifications

Detection performance	Model no.	Current consumption	Lens color	Output type	Detection distance	Detection area		Detection zones
						Horizontal	Vertical	
Standard detection type 	EKMB1101111	1μA	White	Digital	5m	94°	82°	64
	EKMB1101112		Black					
	EKMB1101113		Pearl white					
	EKMB1201111	2μA	White					
	EKMB1201112		Black					
	EKMB1201113		Pearl white					
	EKMB1301111K	6μA	White					
	EKMB1301112K		Black					
	EKMB1301113K		Pearl white					
Long distance detection type 	EKMB1103111	1μA	White	Digital	12m	102°	92°	92
	EKMB1103112		Black					
	EKMB1103113		Pearl white					
	EKMB1203111	2μA	White					
	EKMB1203112		Black					
	EKMB1203113		Pearl white					
	EKMB1303111K	6μA	White					
	EKMB1303112K		Black					
	EKMB1303113K		Pearl white					
Wall installation type 	EKMB1104111	1μA	White	Digital	12m (1st step lens) 6m (2nd step lens) 3m (3rd step lens) Please refer to page 8 for details.	40°	105°	68
	EKMB1104112		Black					
	EKMB1104113		Pearl white					
	EKMB1204111	2μA	White					
	EKMB1204112		Black					
	EKMB1204113		Pearl white					
	EKMB1304111K	6μA	White					
	EKMB1304112K		Black					
	EKMB1304113K		Pearl white					

Ordering information

EKMB 1 1

- PaPIRs motion sensor
- Current consumption in standby mode
1: 1μA / 2: 2μA / 3: 6μA
- Detection (Lens)
00: Lensless / 01: 5m distance standard /
03: 12m long distance / 04: Wall installation type

- Others
K: 6μA / Blank: Other than 6μA
- Lens color
0: Lensless / 1: White /
2: Black / 3: Pearl white
- Lens
0: Lensless / 1: with lens

EKMB series

EKMC series

AMN series

Characteristics

Maximum rated values

Items	Value
Power supply voltage	-0.3 to 4.5V
Ambient temperature	-20 to +60°C (No frost, no condensation)
Storage temperature	-20 to +70°C

Electrical Characteristics

Items	Symbol	1μA type	2μA type	6μA type	Conditions	
Operating voltage	Max	4.0V			—	
	Min	2.3V				
Current consumption (in standby mode) Note 1)	Ave	Iw	1μA	2μA	6μA	Ambient temperature: 25°C Iout=0 Vdd: 3V
Output current (during detection period) Note 2)	Max	Iout	100μA			Ambient temperature: 25°C Vout ≥ Vdd - 0.5
Output voltage (during detection period)	Min	Vout	Vdd - 0.5V			Ambient temperature: 25°C Open at no detection
Circuit stability time (when voltage is applied)	Ave	T _w	25 sec		—	Ambient temperature: 25°C Iout=0 Vdd: 3V
	Max		210 sec		10 sec, Note 3)	

Note 1) The total current consumption is equal to the current consumption in standby mode (Iw) plus the output current during detection (Iout). For the 1μA type please note that the average current consumption is 1μA in sleep mode and 1.9μA in standby mode. Please also refer to the timing chart.

Note 2) Please select an output resistors (pull-down concept) in accordance with Vout so that the output current is lower than or equal to 100μA. If the output current is more than 100μA, this may cause false alarms.

Note 3) The sensor temperature has to be constant for the time specified.

Timing chart

2μA / 6μA type

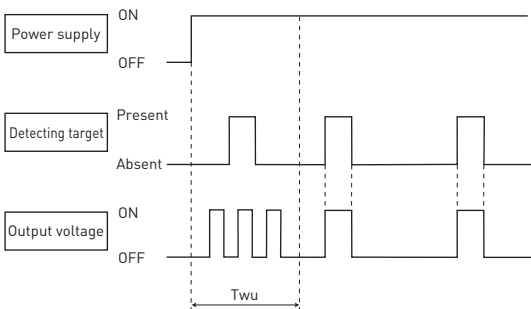

[Explanation of the timing]

T_w: Circuit stability time: about 25 sec (typ.) for 2μA type, max. 10 sec for 6μA type. While the circuitry is stabilizing after the power is turned on, the sensor output is not fixed in the ON or OFF state. This is true regardless of whether or not the sensor has detected anything.

1μA type

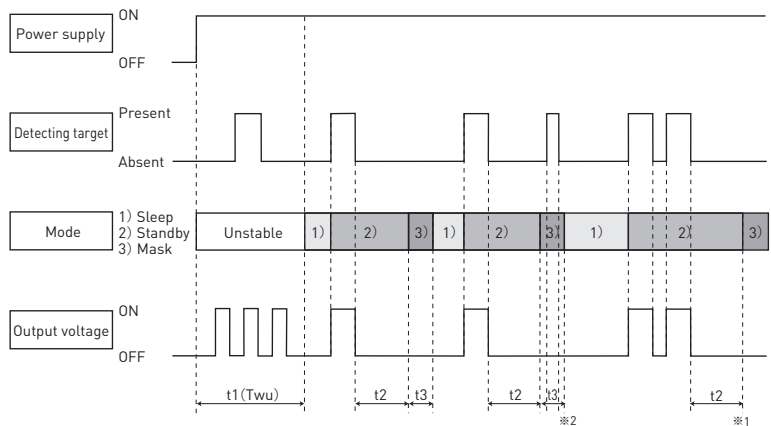

[Explanation of modes]

- 1) Sleep mode: When the output is OFF. The electrical current consumption is around 1μA.
- 2) Standby mode: After the sensor's output has reached ON status, the sensor switches to standby mode. The electrical current consumption gets close to 1.9μA. When the sensor's output returns to its OFF value after the "hold time" has expired, the sensor switches again to sleep mode.
- 3) Mask mode: Time during which the output is forced to OFF status after the end of the standby mode. (No detection is possible during this period.)

[Explanation of the timing]

- t₁ (T_w): Circuit stability time: about 25 sec (typ.)
While the circuitry is stabilizing after the power is turned on, the sensor output is not fixed in the ON or OFF state. This is true regardless of whether or not the sensor has detected anything.
- t₂: Standby hold time: about 2.6 sec (typ.) after the last detection of a signal. (※1)
- t₃: Mask time: about 1.3 sec (typ.) During this stage, even if the sensor detects something, the output will not switch to ON. (※2)

Lenses for the EKMB/EKMC series

Dimension (mm)

Detection zone

Detection characteristics

Standard detection type

CAD data

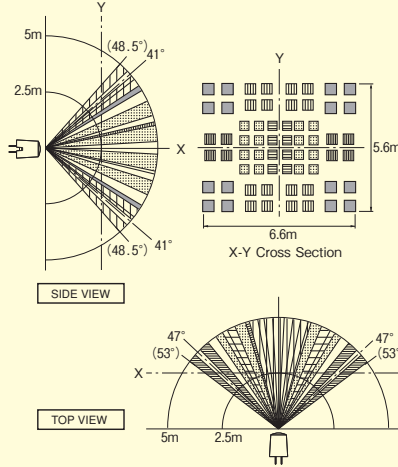
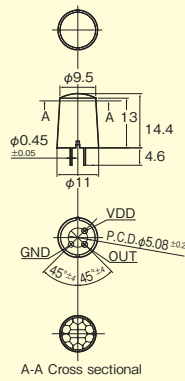

Detection distance	Max. 5m
Field of view	94°×82°
Detection zone	64 beams
Detection condition	<ul style="list-style-type: none"> The temperature difference between the target and the surroundings must be higher than 4°C. Movement speed: 1.0m/s Target concept: Human body with an approx. size of 700×250mm Target moving direction: Crossing the detection beam.

Long distance detection type

CAD data

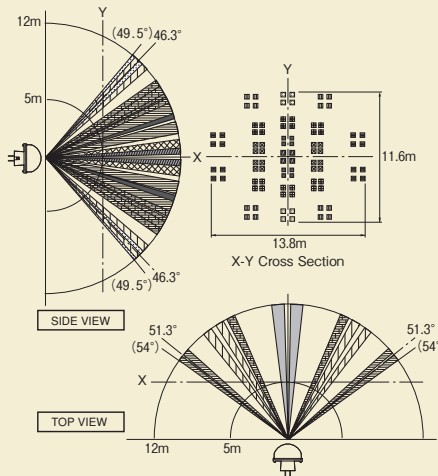
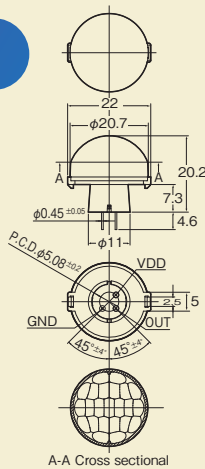

Detection distance	Max. 12m
Field of view	102°×92°
Detection zone	92 beams
Detection condition	<ul style="list-style-type: none"> The temperature difference between the target and the surroundings must be higher than 4°C. Movement speed: 1.0m/s Target concept: Human body with an approx. size of 700×250mm Target moving direction: Crossing the detection beam.

Wall installation type

CAD data

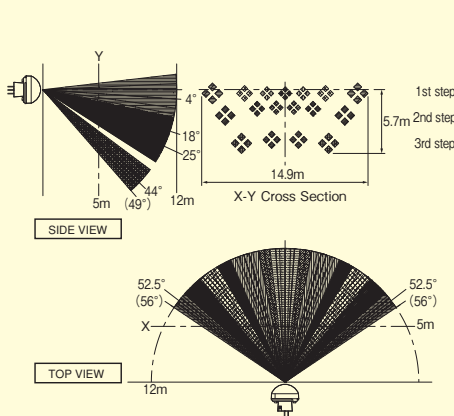
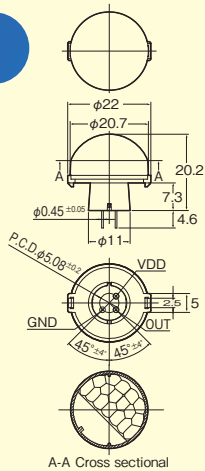

Detection distance	1st step lens	Max. 12m
	2nd step lens	Max. 6m
	3rd step lens	Max. 3m
Field of view	40°×105°	
Detection zone	68 beams	
Detection condition	<ul style="list-style-type: none"> The temperature difference between the target and the surroundings must be higher than 4°C. Movement speed: 1.0m/s Target concept: Human body with an approx. size of 700×250mm Target moving direction: Crossing the detection beam. 	

Lensless type

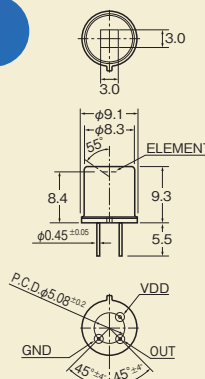

PIR element

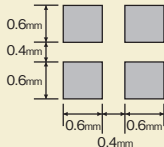

Detection sensitivity	<p>Average: 5.6μW/cm²</p> <p>Maximum: 7.6μW/cm²</p>
-----------------------	---

※Detection sensitivity is measured by following system

Test setup

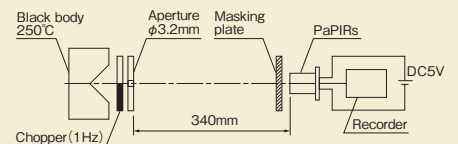

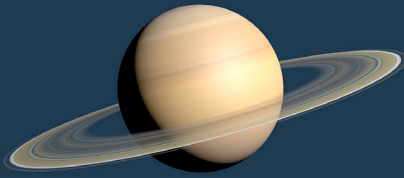

SATURN LENS - Dual zone

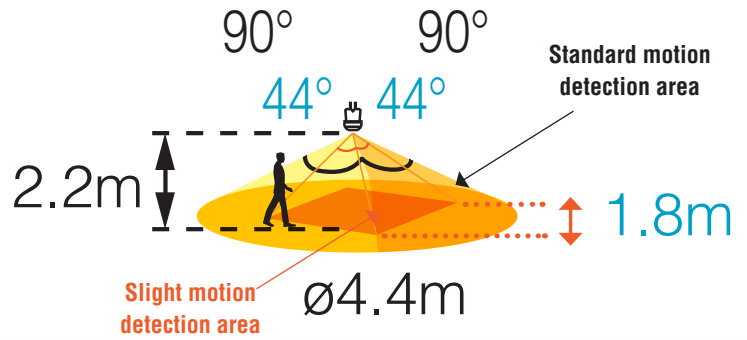

Standard and slight-motion detection type

<p>► Choose by the current consumption in standby mode (1µA type: in sleep mode)</p>		1µA	2µA	6µA	170µA	
	<p>► Choose by output</p>	Digital			Digital	Analog
<p>► Choose by lens color</p>	White	EKMB1193111	EKMB1293111	EKMB1393111K	EKMC1693111	By request
	Black	EKMB1193112	EKMB1293112	EKMB1393112K	EKMC1693112	By request
	Pearl white	EKMB1193113	EKMB1293113	EKMB1393113K	EKMC1693113	By request

Saturn lens

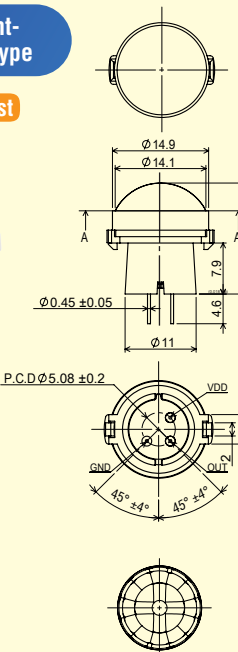
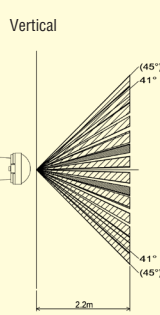
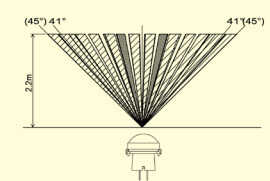
	Dimension (mm)	Detection zone	Detection characteristics
<p>Standard and slight-motion detection type</p> <p>CAD data by request</p>  	<p>Vertical</p>  <p>Horizontal</p> 	<p>Detection distance</p> <p>Max. 2.2m*</p> <p>Field of view</p> <p>Slight motion: 44° x 44° Standard motion: 90° x 90°</p> <p>Detection zone</p> <p>Slight motion: 36 Standard motion: 48</p> <p>Detection condition ▲</p> <p>Slight motion</p> <ul style="list-style-type: none"> The temperature difference between the target and the surroundings must be higher than 4°C. Movement speed: 0.5ms Target concept: Human head with an approx. size of 200x200mm Target moving direction: Crossing the detection beam, 1 zone <p>Standard motion</p> <ul style="list-style-type: none"> The temperature difference between the target and the surroundings must be higher than 4°C. Movement speed: 1.0ms Target concept: Human body with an approx. size of 400x200mm Target moving direction: Crossing the detection beam, 2 zones 	
<p>* Under specified detection conditions</p> <p>▲ Please refer to "Caution for use" (page 13) and "Basic principles" (page 13, point 5), for more details</p>			

Please contact your local sales representative for detailed specifications.