

Evaluating the **AD4115** Single Supply, 24-Bit, 125 kSPS, Sigma-Delta ADC with ± 10 V Inputs

FEATURES

Fully featured evaluation board for the **AD4115**
 PC software for control and data analysis (time domain)

EVALUATION KIT CONTENTS

EVAL-AD4115SDZ
AD411x Eval+ evaluation software
 Plastic screw and washer set

SOFTWARE NEEDED

AD411x Eval+

EQUIPMENT NEEDED

Any of the following **SDP** hardware: **EVAL-SDP-CB1Z (SDP-B)**
 or **EVAL-SDP-CK1Z (SDP-K1)**

DC signal source

PC running Windows with USB 2.0 port

GENERAL DESCRIPTION

The EVAL-AD4115SDZ is a full featured evaluation board that can evaluate all features of the **AD4115**. The **AD4115** is a 24-bit, 125 kSPS, Σ - Δ analog-to-digital converter (ADC) with a ± 10 V input voltage range (16 single-ended channels or eight fully differential channels). All channels have on-board overvoltage and overcurrent protection.

The EVAL-AD4115SDZ includes voltage references and power and data insulation and can be connected to the Analog Devices, Inc., system demonstration platform (**SDP**) hardware. The **SDP** board provides connection to a PC via a universal serial bus (USB) port and can provide power for the EVAL-AD4115SDZ from the PC USB port.

The **AD411x Eval+** evaluation software configures the **AD4115** functionality and provides dc time domain analysis in the form of waveform graphs, histograms, and associated noise analysis for ADC performance evaluation.

Full specifications for the **AD4115** are available in the **AD4115** data sheet, which must be consulted in conjunction with this user guide when working with the EVAL-AD4115SDZ.

EVALUATION BOARD PHOTOGRAPH

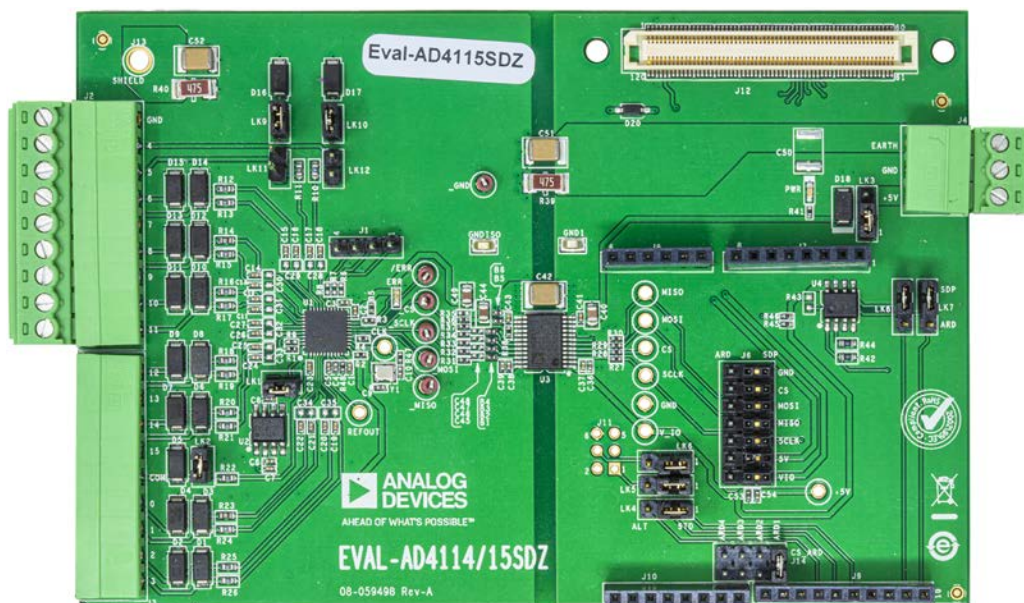

Figure 1.

23998-001

TABLE OF CONTENTS

Features	1	Power Supplies.....	6
Evaluation Kit Contents.....	1	Analog Inputs	6
Software Needed	1	Reference Options	6
Equipment Needed.....	1	Evaluation Board Software.....	7
General Description	1	Software Installation Procedures.....	7
Evaluation Board Photograph.....	1	Software Operation	11
Revision History	2	Configuration Tab	11
Evaluation Board Block Diagram.....	3	Waveform Tabs	13
EVAL-AD4115SDZ Quick Start Guide	4	Histogram Tab	15
Recommended Quick Start Guide	4	Register Map Tab (Advanced Mode Only)	16
Quick Start Measurement	4	Exiting the Software.....	16
Evaluation Board Hardware.....	5	Evaluation Board Schematics and Artwork.....	17
Device Description.....	5	Ordering Information.....	23
Hardware Link Options.....	5	Bill of Materials.....	23
Evaluation Board Setup Procedure	5		
Serial Interface	6		

REVISION HISTORY

7/2020—Revision 0: Initial Version

EVALUATION BOARD BLOCK DIAGRAM

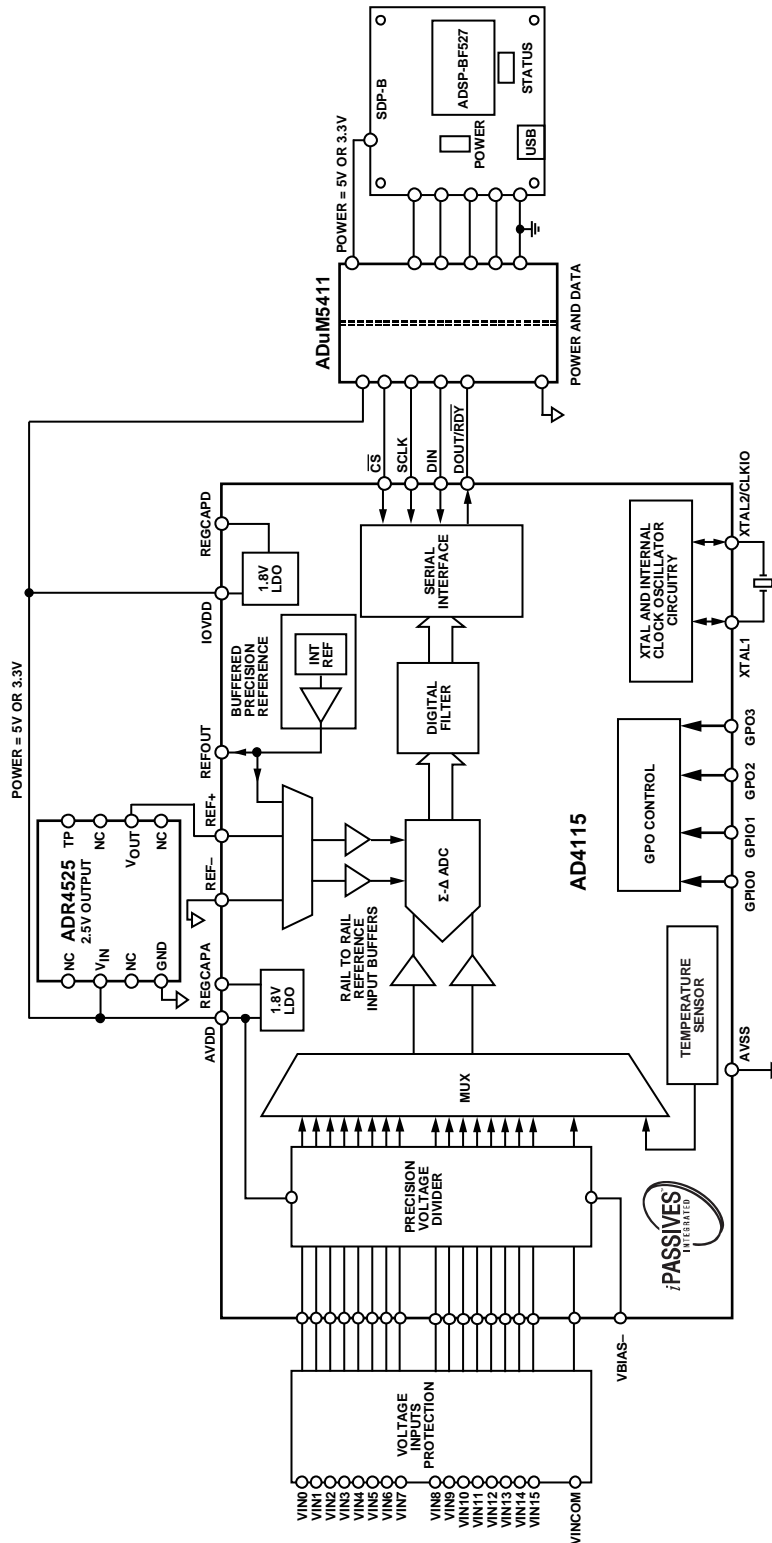

2399-002

Figure 2. Evaluation Board Block Diagram

NOTES
1. FOR SIMPLICITY DECOUPLING IS NOT SHOWN.

EVAL-AD4115SDZ QUICK START GUIDE

RECOMMENDED QUICK START GUIDE

Use the following procedure to set up the EVAL-AD4115SDZ:

1. Disconnect the **SDP** (**SDP-B** or **SDP-K1**) board from the USB port of the PC. Install the **AD411x Eval+** software. See the Installing the AD411x Eval+ Software section. Restart the PC after installation.
2. Connect the **SDP** board to the EVAL-AD4115SDZ. Fasten these two boards together with the enclosed plastic screw washer set.
3. Fasten the EVAL-AD4115SDZ and the **SDP** board together with the enclosed plastic screw washer set.
4. Connect the **SDP** board to the PC via the USB cable. For Windows® XP, it may be necessary to search for the **SDP** drivers. Choose to automatically search for the drivers for the **SDP** board if prompted by the operating system.

5. Launch the **AD411x Eval+** software from the **Analog Devices** subfolder in the **Programs** menu.

QUICK START MEASUREMENT

Use the following procedure to capture data quickly:

1. Connect the dc signal source to a selected voltage input (for example, the VIN0 pin and VIN1 pin for differential input).
2. Launch the **AD411x Eval+** software and select **Quickstart** (see Figure 15).
3. In the **Configuration** tab, under **Demo Modes**, click **All Single-Ended** and then click **Sample** (see Figure 16).
4. In the **Voltage Waveform** tab, the user can evaluate the measured data.

The **Samples** box in the top right corner of the **AD411x Eval+** window sets the number of samples collected in each batch.

EVALUATION BOARD HARDWARE

DEVICE DESCRIPTION

The AD4115 is a highly accurate, high resolution, multiplexed, Σ - Δ ADC with 16 single-ended or 8 differential voltage inputs and a voltage range of -10 V to $+10$ V. The maximum channel to channel scan rate is 24,845 kSPS (40.25 μ s) for fully settled data. The output data rates range from 2.5 SPS to 125 kSPS. The device includes integrated analog reference buffers, an integrated precision 2.5 V reference, and an integrated oscillator.

See the AD4115 data sheet for complete specifications. Consult the data sheet in conjunction with this user guide when using the EVAL-AD4115SDZ.

HARDWARE LINK OPTIONS

See Table 1 for the default link options. By default, the EVAL-AD4115SDZ is powered from and controlled by the SDP board connected to J12. The ADuM5411 (U3) output is set to 5 V.

EVALUATION BOARD SETUP PROCEDURE

After following the instructions in the Software Installation Procedures section, set up the EVAL-AD4115SDZ and SDP board as detailed in the Configuring the EVAL-AD4115SDZ and SDP Boards section.

The evaluation software and drivers must be installed before connecting the EVAL-AD4115SDZ and SDP board to the USB port of the PC to ensure that the PC correctly recognizes the evaluation system.

Configuring the EVAL-AD4115SDZ and SDP Boards

Use the following procedure to configure the boards:

1. Connect the SDP board to Connector A or Connector B on the EVAL-AD4115SDZ. Screw the two boards firmly together using the plastic screw and washer set included in the evaluation board kit.
2. If using the SDP-K1 board, the Arduino headers can also be used to connect to the EVAL-AD4115SDZ. If the Arduino headers are used, the J6 links must be changed to ARD.
3. Ensure that LK3 is in Position B (USB).
4. Connect the SDP board to the PC using the USB cable.

Table 1. Default Link and Solder Link Options

Link	Default Option	Description
LK1	Inserted	Connects the on-board external reference ADR4525ARZ (U2) to the AD4115 (U1). Remove LK1 if using a different single-ended external reference.
LK2	Inserted	Connects VINCOM to GND_ISO. This configuration is typical for single-ended measurement. Remove LK2 to set the custom common analog input for single-ended channels. VINCOM is available on Pin 5 of J3.
LK3	B (USB)	Selects the power supply voltage. Position A: EVAL-AD4115SDZ is powered from the external dc power supply connector, J4. Position B: EVAL-AD4115SDZ is powered from the USB through the SDP or Arduino connector.
LK4 to LK6	SDP	Selects which Arduino serial peripheral interface (SPI) lines to connect to J6. STD: Standard Arduino headers. ALT: Alternate in-circuit serial programming (ICSP) header.
LK7, LK8	SDP	Selects the I ² C source for the on board electronically erasable programmable read-only memory (EEPROM). SDP: SDP connector. ARD: Arduino header.
LK9, LK10	Inserted	Connects VIN4 and VIN5 to the Zener diodes D16 and D17, respectively. VIN4 and VIN5 can be removed to evaluate the voltage inputs of the AD4115 directly by removing external components.
LK11, LK12	Removed	Bypasses R10 and R11 on VIN4 and VIN5, respectively. By inserting this link, the resistor is removed from the input path and AD4115 can be evaluated directly.
J6	SDP	Selects between the Arduino headers and the SDP connector, and has the active connector for power and SPI signals. SDP: SDP connector. ARD: Arduino header.
J14	CS0	Selects which GPIOx pin to use on the Arduino header to enable \overline{CS} connections when stacking evaluation boards.
R35	Open	Sets the ADuM5411 (U3) isolated regulator output voltage. Open: +VA_ISO = 5 V. Short: +VA_ISO = 3.3 V.

SERIAL INTERFACE

The EVAL-AD4115SDZ connects via the SPI to either the [SDP](#) connector or [Arduino](#) header. There are four primary signals, three inputs (\overline{CS} , SCLK, and DIN), and one output from the ADC (DOUT/RDY).

The EVAL-AD4115SDZ connects to any microcontroller board that uses the [Arduino](#) standard headers. The [Arduino](#) standard headers allow the user to develop code for a variety of platforms.

To operate the EVAL-AD4115SDZ in standalone mode, disconnect any [SDP](#) board connected, remove the jumpers in the J6 header, and use the middle row of pins on J6 to access all SPI signals and set the input/output voltage levels.

POWER SUPPLIES

By default, the EVAL-AD4115SDZ is powered from the USB. The EVAL-AD4115SDZ can also be powered from the J4 connector by setting LK3 to Position A, or from Pin +5V on Connector J6 (see Table 2).

The [ADuM5411](#) *isoPower*[®] digital isolator is used to isolate power and data lines up to 2.5 kV rms.

ANALOG INPUTS

Sixteen voltage inputs are available on J2 and J3. If a different common voltage must be set for single-ended measurement, remove LK2 and connect the desired voltage to VINCOM on J3.

REFERENCE OPTIONS

The EVAL-AD4115SDZ includes an external 2.5 V reference, the [ADR4525ARZ](#). By default, LK1 is inserted, connecting the external reference to the REF+ pin of the [AD4115](#). Remove LK1 if using a different single-ended external reference.

In the [AD411x Eval+](#) evaluation software, click the blue + pop-up button associated with Setup 0 to Setup 7 to select the reference used for conversions by the [AD4115](#) (see Figure 16). The pop-up button is located below the external reference controls in the block diagram (Label 7 in Figure 16).

Table 2. Connector Details

Connector	Function	Connector Type	Manufacturer	Part Number
J1	Connects to the GPIOx pins of the AD4115	4-pin header, 2.54 mm pitch	Harwin	M20-9990445
J2, J3	Voltage inputs to AD4115	Connectors, headers, 90°, 9-position, 3.81 mm	Phoenix Contact	1803345
J4	External supply voltage (optional)	Power socket block, 3-way, 3.81 mm pitch	Phoenix Contact	1803280
J7, J10	Arduino headers	8-position receptacle connectors, 2.54 mm pitch	Samtec	SSQ-108-03-G-S
J8	Arduino header	6-position receptacle connector, 2.54 mm pitch	Samtec	SSQ-106-03-G-S
J9	Arduino header	10-position receptacle connector, 2.54 mm pitch	Samtec	SSQ-110-03-G-S
J11	Arduino ICSP header	6-position, 2 row, receptacle connector, 2.54 mm pitch	Samtec	SSQ-103-03-G-D
J12	SDP connector	120-way connector, 0.6 mm pitch	HRS	FX8-120S-SV(21)
J13	Earth for electrostatic discharge (ESD) testing	Not applicable	Not applicable	Not applicable

EVALUATION BOARD SOFTWARE SOFTWARE INSTALLATION PROCEDURES

The EVAL-AD4115SDZ evaluation kit includes a link to the software that must be installed before using the EVAL-AD4115SDZ.

The following two installations are required:

- **AD411x Eval+** software installation
- **SDP** drivers installation

The **AD411x Eval+** evaluation software and drivers must be installed before connecting the EVAL-AD4115SDZ and **SDP** board to the USB port of the PC to ensure that the PC correctly recognizes the evaluation system.

Installing the AD411x Eval+ Software

To install the **AD411x Eval+** software, take the following steps:

1. With the **SDP** board disconnected from the USB port of the PC, download and unzip the **AD411x Eval+** software installer file from the EVAL-AD4115SDZ product page.
2. Double-click the **setup.exe** file to begin the evaluation board software installation. The software then installs to the following default location: **C:\Program Files (x86)\Analog Devices\AD411xEval+**.
3. A dialog box appears asking for permission to allow the program to make changes to the PC. Click **Yes** (see Figure 3).

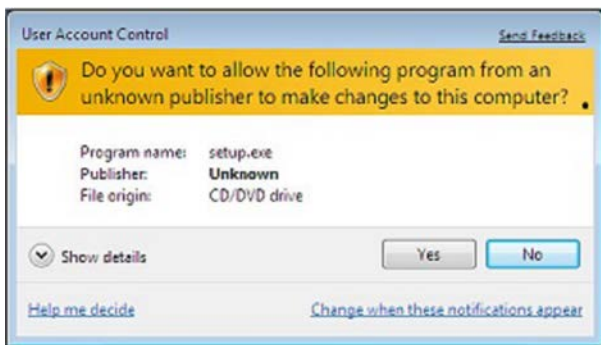

Figure 3. Granting Permission for the Program to Make Changes to PC

4. Select a location to install the software and then click **Next**. Figure 4 shows the default locations displayed when the dialogue box opens, but another location can be selected by clicking **Browse**.

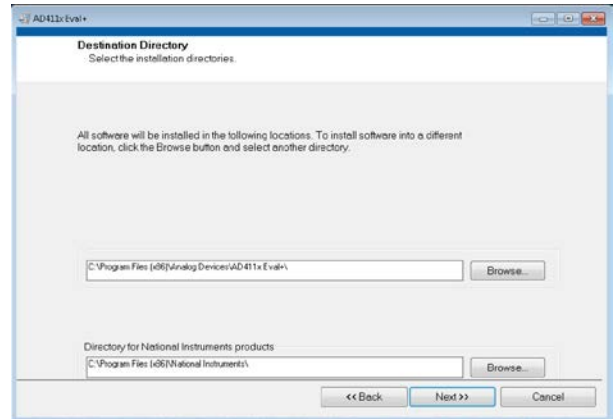

Figure 4. Selecting the Location for Software Installation

5. A license agreement appears. Read the agreement, select **I accept the License Agreement**, and click **Next**.

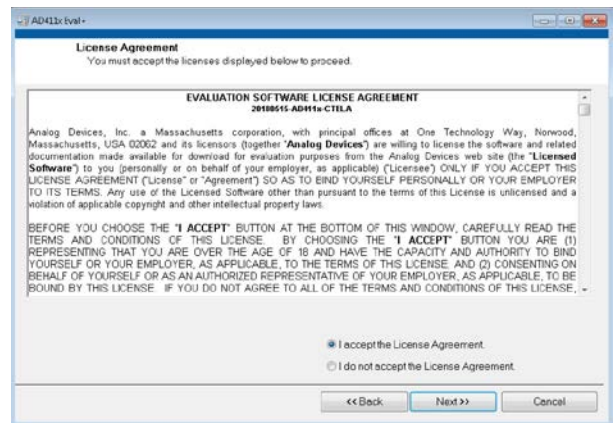

Figure 5. Accepting the License Agreement

6. A summary of the installation displays. Click **Next** to continue.

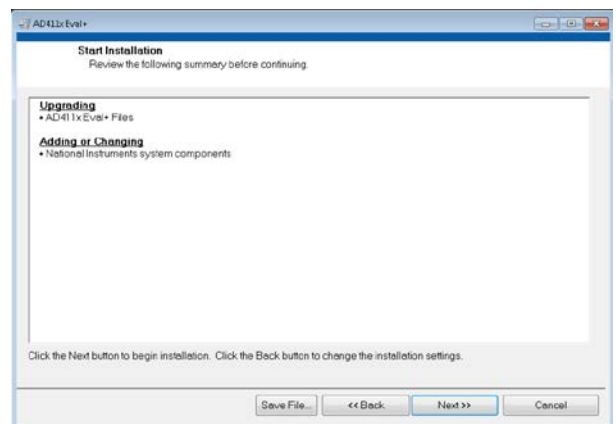

Figure 6. Reviewing a Summary of the Installation

7. The message in Figure 7 appears when the installation is complete. Click **Next**.

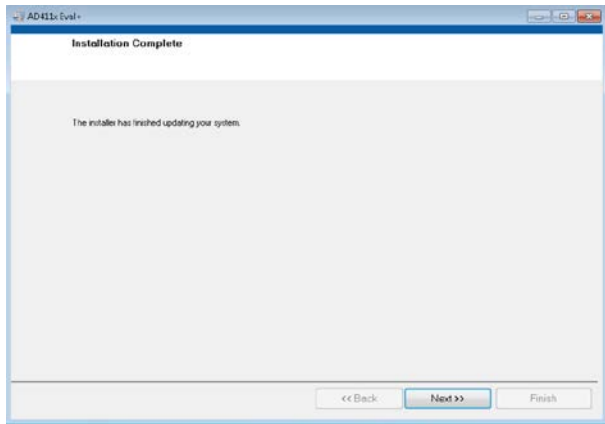

Figure 7. Indicating When the Installation is Complete

Installing the SDP Drivers

After the installation of the **AD411x Eval+** evaluation software is complete, a welcome window appears for the installation of the **SDP** drivers. Take the following steps to install the **SDP** drivers:

1. Click **Next** to proceed with the installation wizard.



Figure 8. Welcome Window for SDP Drivers Installations

2. With the **SDP** board still disconnected from the USB port of the PC, ensure that all other applications are closed, and then click **Install**.

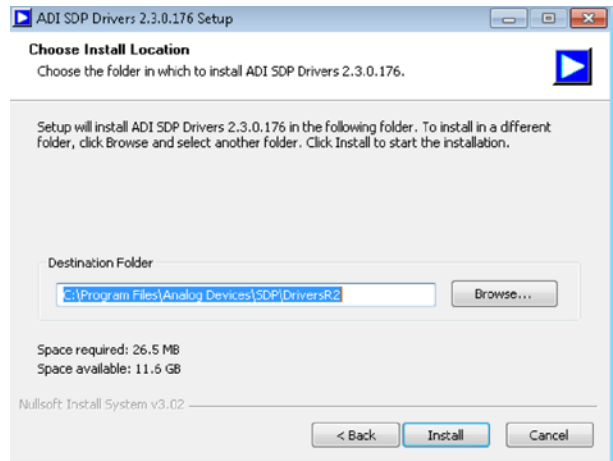

Figure 9. Beginning the SDP Drivers Installation

3. To complete the driver installation, click **Close**, which closes the installation setup wizard.

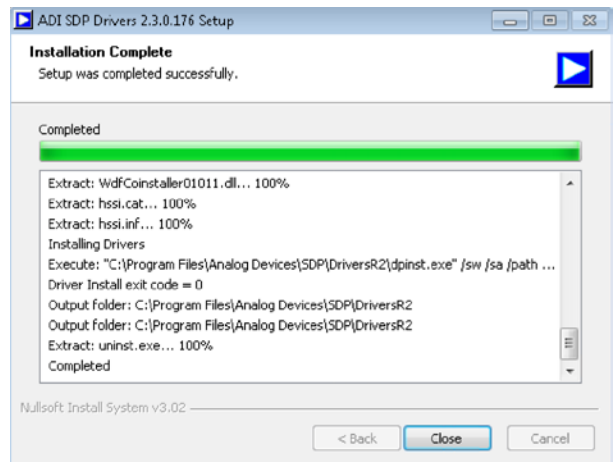

Figure 10. Completing the SDP Drivers Setup Wizard

4. Before using the EVAL-AD4115SDZ, restart the PC.



Figure 11. Restarting the PC

Setting Up the System for Data Capture

After completing the steps in the Software Installation Procedures section and the Evaluation Board Hardware section, set up the system for data capture as follows:

1. Allow the **Found New Hardware** wizard to run after connecting the **SDP** board to the PC. If using Windows XP, it may be necessary to search for the **SDP** drivers. Choose to automatically search for the drivers for the **SDP** board if prompted by the operating system.
2. Check that the EVAL-AD4115SDZ is connected to the PC correctly using the **Device Manager** of the PC. Access the **Device Manager** as follows:
 - a. Right-click **My Computer** and then click **Manage**.
 - b. A dialog box appears asking for permission to allow the program to make changes to the PC. Click **Yes**.
 - c. The **Computer Management** window appears. Click **Device Manager** from the **System Tools** list (see Figure 12).
 - d. If the **SDP** board appears under **ADI Development Tools** in the **TEST PC** nested list, the driver software has installed and the **SDP** board is connected to the PC correctly.

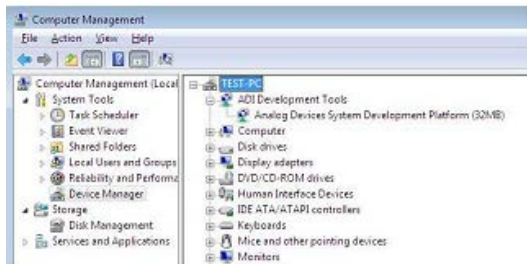

Figure 12. Checking if the SDP Board is Connected to the PC Correctly

Launching the Software

After completing the steps in the Setting Up the System for Data Capture section, launch the **AD411x Eval+** software as follows:

1. From the **Start** menu, click **Programs > Analog Devices > AD411x Eval+ > AD411x Eval+.exe**. The dialog box shown in Figure 13 appears. Select **AD4115 Evaluation Board** and the main window of the software shown in Figure 16 appears.

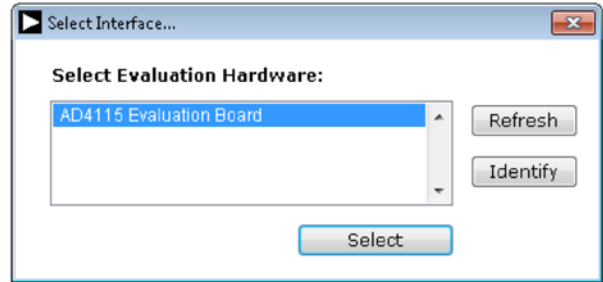

Figure 13. AD4115 Evaluation Board Selection

2. If the EVAL-AD4115SDZ is not connected to the USB port via the **SDP** when the software is launched, the software displays the dialog box shown in Figure 14. Connect the EVAL-AD4115SDZ to the USB port of the PC, wait a few seconds, then click **Refresh**, and the dialog box shown in Figure 13 then appears.

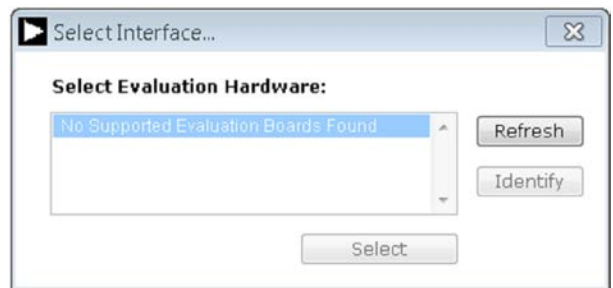

Figure 14. Evaluation Board Selection, No Board Connected

3. The dialog box shown in Figure 15 appears as a pop-up over Figure 16. Quick start mode provides a simplified version of the software that can be used as a starting point for evaluating the **AD4115**. This mode provides a graphical user interface (GUI) for setting up inputs, as shown in Figure 16, and allows the user to configure the device further by using the blue + configuration buttons (Label 7 in Figure 16).
4. Advanced mode can be used when more configurability of the inputs is required. In this mode, the input GUI is not available. However, the user has access to the **Registers** tab, which provides full control of the **AD4115** register map (see Figure 17). When operating in advanced mode, the user must consult the **AD4115** data sheet.

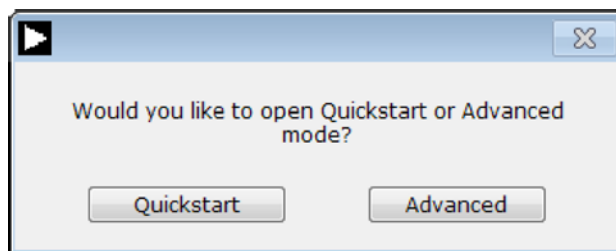

Figure 15. AD411x Eval+ Startup Mode Selection

The screenshot shows the AD4115 Eval+ software interface. The main window title is "AD4115 Eval+" and it includes the Analog Devices logo. The interface is divided into several sections:

- Configuration Tab:** Includes "Voltage Waveform", "Noise Table", and "Histogram" sub-tabs. The "Sampling Mode" is set to "Single Capture" and "Samples" is set to "100". A "Sample" button is present.
- Inputs (1):** A table for configuring input channels.

SE	Diff	Range
<input type="checkbox"/>	<input checked="" type="checkbox"/>	+/-10V
<input type="checkbox"/>	<input type="checkbox"/>	+/-10V
<input type="checkbox"/>	<input type="checkbox"/>	+/-10V
<input type="checkbox"/>	<input type="checkbox"/>	+/-10V
<input type="checkbox"/>	<input type="checkbox"/>	+/-10V
<input type="checkbox"/>	<input type="checkbox"/>	+/-10V
- ODR Settings (2):**

ODR(Hz)	Time(ms)	Total Time (ms)
125000	0.008	0.008
- Demo Modes (3):**
 - Reset
 - All Single-Ended
 - All Differential
- Save and Load Register Map Configuration (13):**
 - Save
 - Load
 - Export..
- AVDD (V) (9):** 5
- Ext. REF-(V) (8):** 0
- Ext. REF+(V) (8):** 2.5
- AVSS (V) (10):** 0
- Channel Selection (7):** CH0 - CH7
- Channel Selection (6):** CH8 - CH15
- Device Error (12):** Busy

The central part of the interface displays a detailed circuit diagram of the AD4115 ADC. The diagram includes components such as the Precision Voltage Divider, Multiplexer (MUX), Z-A ADC, Digital Filter, and Serial Interface. It also shows power supply connections for AVDD, AVSS, and 1.8V LDOs, as well as various control pins like CS, SCLK, DIN, DOUT/RDY, SYNC, and ERROR. The diagram is annotated with red boxes and numbers corresponding to the configuration settings.

Figure 16. Configuration Tab in Quick Start Mode

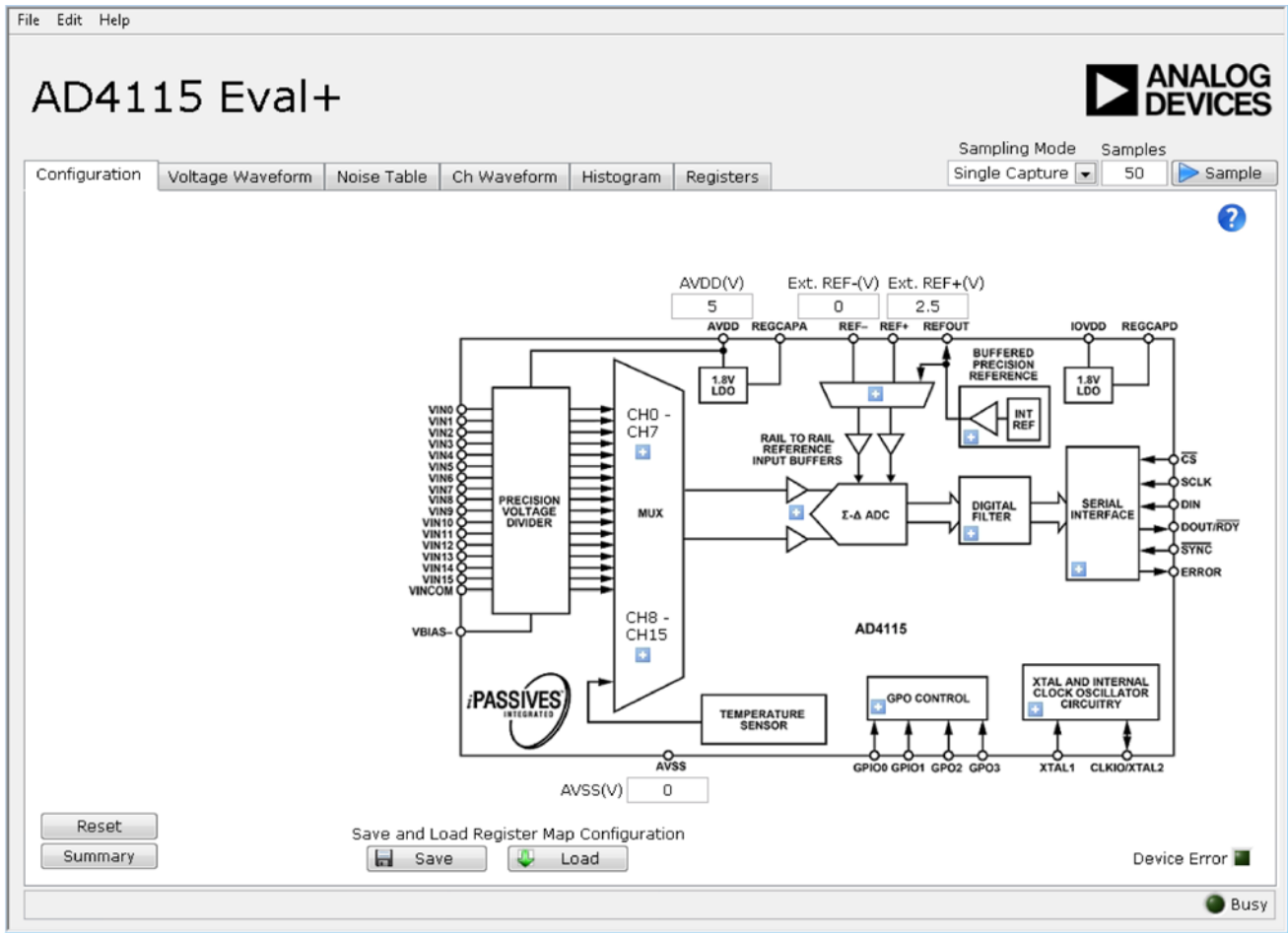

Figure 17. Configuration Tab in Advanced Mode

SOFTWARE OPERATION

Overview of the Main Window

After selecting **AD4115 Evaluation Board**, shown in Figure 13, the main window of the evaluation software displays, as shown in Figure 16. The **Configuration** tab shows the control buttons and analysis indicators of the **AD411x Eval+** software. The main window of the **AD411x Eval+** software in quick start mode contains four tabs: **Configuration**, **Voltage Waveform**, **Noise Table**, and **Histogram**.

In advanced mode, two additional tabs are available: **Ch Waveform** and **Registers**.

CONFIGURATION TAB

The **Configuration** tab shows a block diagram of the **AD4115**. This tab allows the user to select inputs, set up the ADC, reset the ADC, view errors present, and configure the device for different demonstration modes. Figure 16 shows the **Configuration** tab in detail, and the following sections discuss the different elements on the **Configuration** tab of the software window.

Inputs (Quick Start Mode Only)

The **AD4115** has 16 voltage inputs that can be configured as single-ended or fully differential pairs (Label 1 in Figure 16).

Use the **Vin0 - Vin7** and **Vin8 - V15** buttons to select between inputs.

The voltage range can also be set per input to -10 V to $+10\text{ V}$, -5 V to $+5\text{ V}$, 0 V to $+10\text{ V}$, or 0 V to $+5\text{ V}$. Changing the appropriate voltage range provides more realistic values for **P - P Resolution** and **RMS Resolution** shown in the noise analysis area (Label 23 in Figure 18).

Output Data Rate (ODR)/Measurement Time

The ODR can be set for all inputs in the **Configuration** tab (Label 2 in Figure 16). Set the ODR by entering a value in hertz into the **ODR(Hz)** box or a measurement time in milliseconds into the **Time(ms)** box. If an ODR is entered, the software calculates the measurement time. If a time is entered, the software calculates the fastest ODR that can achieve the required measurement time.

The device only supports a certain number of ODRs. Therefore, the software rounds up to the closest available value. ODR values depend on if a single channel or multiple channels are enabled. The fastest ODRs are available if only one channel is enabled. The values shown are valid for the sinc5 + sinc1 filter, which is enabled by default. If the sinc3 filter is enabled instead, refer to the [AD4115](#) data sheet for the corresponding values.

The value in the **Time(ms)** box represents time taken for one sample for one enabled channel.

The value in the **Total Time (ms)** box represents the total time to take one sample for all enabled inputs.

Demo Modes

The [AD411x Eval+](#) software contains a number of demonstration modes in the **Demo Modes** area (Label 3 in Figure 16). These demonstration modes configure the [AD4115](#) for each of the input types (represented by **All Single-Ended** and **All Differential**).

Reset

Click **Reset** to perform a software reset of the [AD4115](#) (Label 4 in Figure 16). There is no hardware reset pin on the [AD4115](#).

To perform a hard reset, remove power from the EVAL-AD4115SDZ. The software reset has the same effect as a hard reset.

Tutorial Button

Click the tutorial button (Label 5 in Figure 16) to open a tutorial on using the [AD411x Eval+](#) software and for additional information on using the [AD411x Eval+](#) software. Click the blue + information buttons for further information on different elements of the **Configuration** tab.

Functional Block Diagram

The functional block diagram of the [AD4115](#) (Label 6 in Figure 16) shows each of the functional blocks within the [AD4115](#). Clicking a configuration button on the functional block diagram opens the configuration window for that block.

Configuration Pop-Up Button

Each + configuration button (Label 7 in Figure 16) opens a different window to configure the relevant functional block.

External Parameters

There are three external parameters that are set by the EVAL-AD4115SDZ but must be entered into the software. The three external parameters are the external reference (Label 8 in Figure 16), AVDD (Label 9 in Figure 16), and AVSS (Label 10 in Figure 16). The external reference on the EVAL-AD4115SDZ is set to 2.5 V by using an [ADR4525](#). If bypassing the [ADR4525](#) on board, change the external reference voltage value in the software to ensure correct calculation of results in the **Voltage Waveform** and **Histogram** tabs.

Configuration Summary

Click **Summary** (Label 11 in Figure 16) to show the input configuration, channel configuration, and information on each of the individual setups, as well as information on any error present. The **Input Configuration**, **Channel Configuration**, and **Information** tabs can be used to quickly check how the ADC inputs and channels are configured, as well as any errors that are present.

Status Bar

The status bar (Label 12 in Figure 16) displays status updates such as **Analysis Completed**, **Reset Completed**, and **Writing to Registers During Software Use**, as well as the **Busy** indicator.

Save and Load

Save and **Load** (Label 39 in Figure 20) allow the user to save the current register map setting to a file and to load the setting from the same file, respectively. The **Export** button exports the register settings as a header file that is compatible with the [AD411x No operating system software drivers](#). An example showing how this configuration file can be used with the [AD411x No operating system software drivers](#) to enable rapid prototyping can be found at the [AD717x/AD411x Mbed Example](#) site.

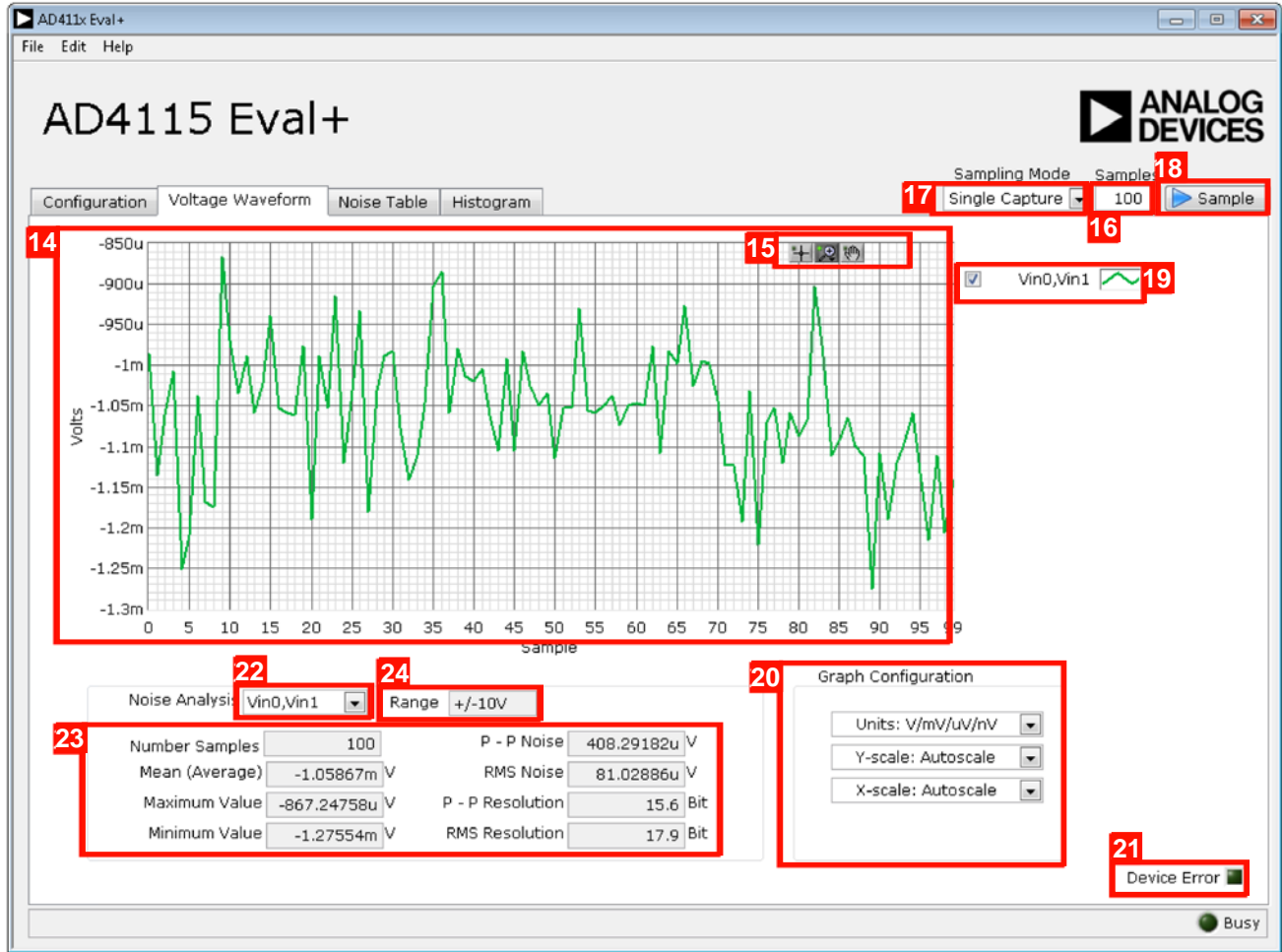

Figure 18. Voltage Waveform Tab

WAVEFORM TABS

The AD411x Eval+ software has two different waveform tabs: **Voltage Waveform** and **Ch Waveform** (in advanced mode only). The waveform tabs graph the conversions gathered and processes the data, calculating the **P - P Noise**, **RMS Noise**, and resolutions (see Figure 18). The **Voltage Waveform** tab graphs the data at the voltage input in quick start mode. The **Ch Waveform** tab shows the data converted per channel in advanced mode.

Waveform Graph and Controls

The data waveform graph (Label 14 in Figure 18) shows each successive sample of the ADC output. Zoom in on the data in the graph using the control buttons (Label 15 in Figure 18). Change the scales on the graph by typing values into the x-axis and y-axis.

Samples

The **Samples** box (Label 16 in Figure 18) and **Sampling Mode** (Label 17 in Figure 18) set the number of samples gathered per batch. If **Sampling Mode** is set to **Single Capture**, the ADC returns the number of samples specified in the **Samples** box. If **Sampling Mode** is set to **Continuous**, the ADC continuously returns samples until stopped by the user. **Samples** specifies the

amount of samples to be shown on the data graph. **Samples** is unrelated to the ADC mode.

Sample

Click **Sample** (Label 18 in Figure 18) to start gathering ADC results. Results appear in the waveform graph.

Plot Selection

The plot selection control area (Label 19 in Figure 18) allows the user to select which inputs display on the data waveform and shows the name of the input.

These controls only affect the waveform graphs and have no effect on the channel settings in the ADC register map.

Display Units and Axis Controls

Click the **Units: V/mV/uV/nV** box in the **Graph Configuration** area (Label 20 in Figure 18) to select whether the data graph displays units of voltage in amps or codes. This control is independent for each graph. The **Y-scale: Autoscale** and **X-scale: Autoscale** boxes can be set to autoscale or fixed scaling. When **Autoscale** is selected, the axis automatically adjusts to show the entire range of the ADC results after each batch of samples. When **Fixed** is selected, the axis range can be set by the user. These ranges do not automatically adjust after each batch of samples.

Device Error

The **Device Error** indicator (Label 21 in Figure 18) illuminates in the **Voltage Waveform** tab and **Ch Waveform** tab when a cyclic redundancy check (CRC) error or an error in the ADC is detected. More specific information on the error can be found by clicking **Summary** in the **Configuration** tab (Label 11 in Figure 16).

Analysis Input

The **Noise Analysis** box shows the analysis of the input selected via the analysis control (Label 22 in Figure 18).

Noise Analysis

The noise analysis area (Label 23 in Figure 18) displays the results of the noise analysis for the selected analysis input, including both noise and resolution measurements.

Input Range

The **Range** box (Label 24 in Figure 18) is an indicator in quick start mode. The value is selected in the **Inputs** area on the **Configuration** tab (Label 1 in Figure 16). In advanced mode, **Range** is a control that allows the user to select an input range for the input chosen for noise analysis.

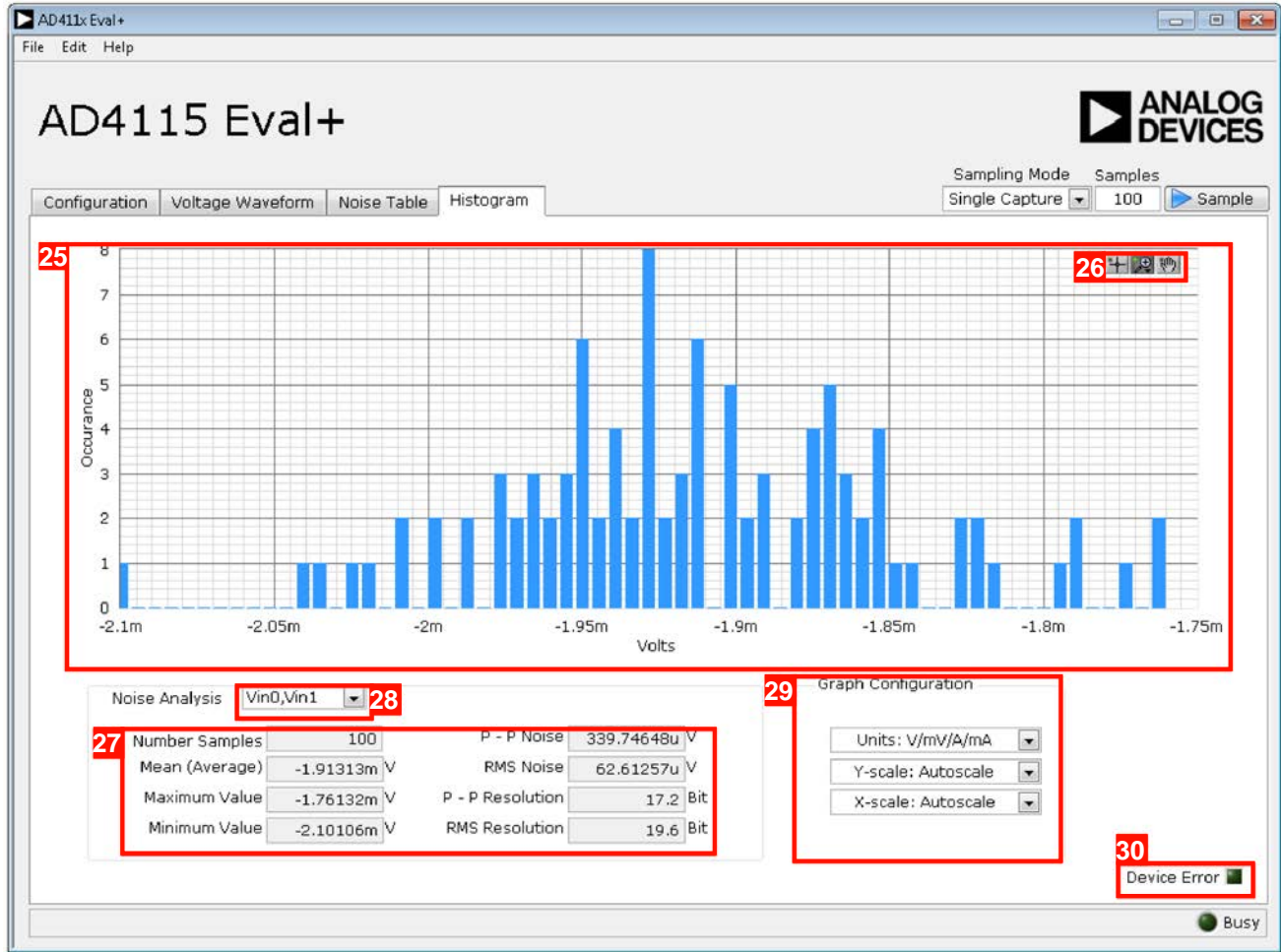

Figure 19. Histogram Tab of the AD411x Eval+ Software

HISTOGRAM TAB

The **Histogram** tab generates a histogram using the gathered samples and processes the data to calculate the **P - P Noise**, **RMS Noise**, and resolutions (see Figure 19).

Histogram Graph and Controls

The data histogram graph (Label 25 in Figure 19) shows the number of times each sample of the ADC output occurs. Zoom in on the data using the control buttons (Label 26 in Figure 19) in the graph. Change the scales on the graph by typing values into the x-axis and y-axis.

Analysis Input

The data used to generate the histogram and values in the noise analysis area (Label 27 in Figure 19) is set by the **Noise Analysis** box (Label 28 in Figure 19). All enabled inputs appear here in the **Noise Analysis** box.

Noise Analysis

The noise analysis area (Label 27 in Figure 19) displays the results of the noise analysis for the selected analysis input, including both noise and resolution measurements.

Display Units and Axis Controls

Click the **Units: V/mV/A/mA** box in the **Graph Configuration** area (Label 29 in Figure 19) to select whether the data graph displays in units of voltages, amps, or codes. This control is independent for each graph.

The **Y-scale: Autoscale** and **X-scale: Autoscale** boxes can be set to autoscale or fixed scaling. When **Autoscale** is selected, the axis automatically adjusts to show the entire range of the ADC results after each batch of samples. When **Fixed** is selected, the user can set the axis range. These ranges do not automatically adjust after each batch of samples.

Device Error

The **Device Error** indicator (Label 30 in Figure 19) illuminates in the **Histogram** tab when a CRC error or an error in the ADC is detected. More specific information on the error can be found by clicking **Summary** in the **Configuration** tab (Label 11 in Figure 16).

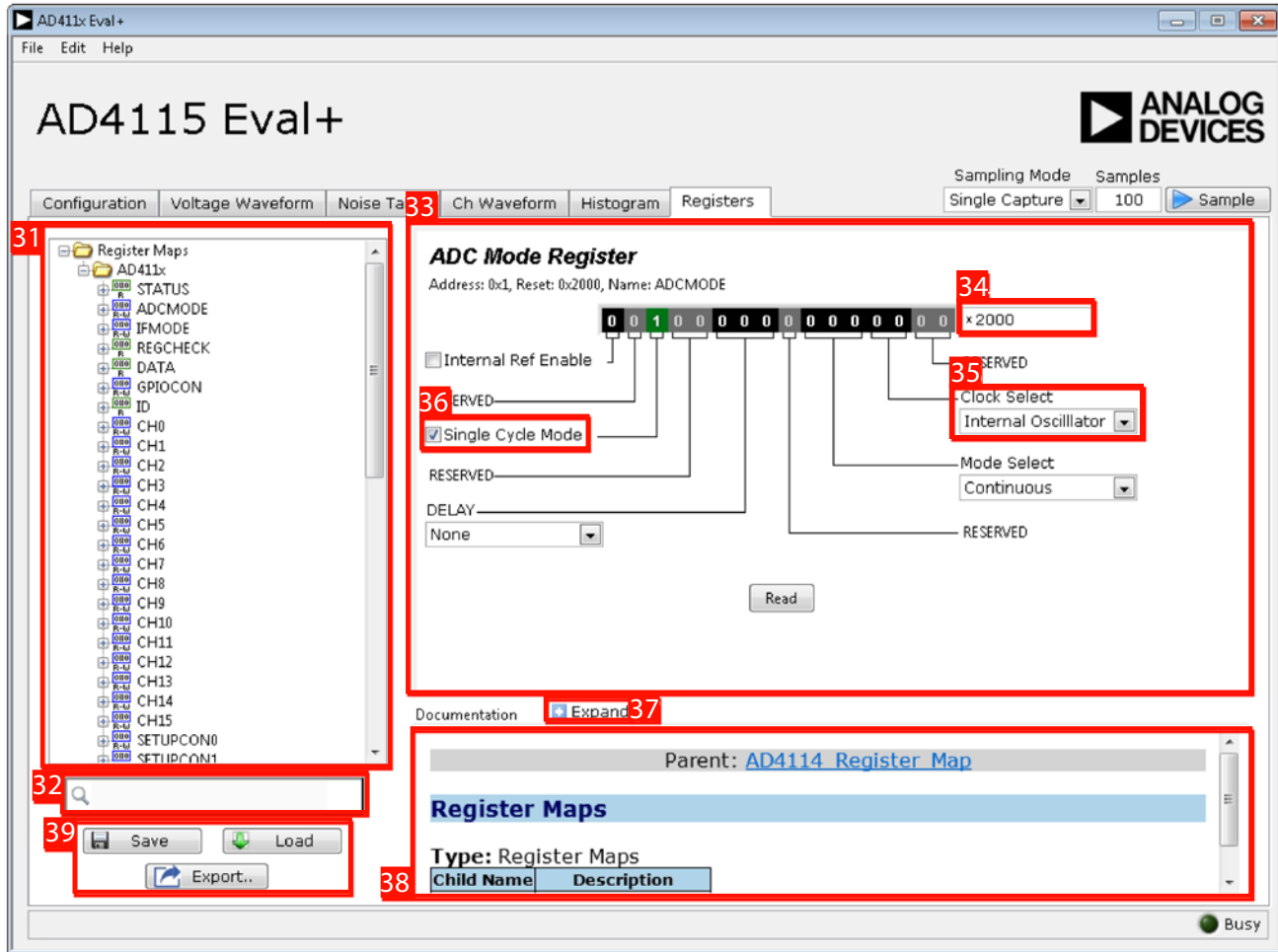

Figure 20. Registers Tab

REGISTER MAP TAB (ADVANCED MODE ONLY)

Register Maps List

Click the **Register Maps** nested list (Label 31 in Figure 20) to show each register. Click the expand button next to each register to show the bit fields contained within that register.

Register Maps Search

The search box (Label 32 in Figure 20) allows the user to search the register maps list for any register or bit field. Entering a value into this control filters the register list.

Register and Bit Field Control

The register control area (Label 33 in Figure 20) allows the user to change the individual bit of the register selected in the register map list by clicking the bits in the register control or by programming the register value directly into the value control box (Label 34 in Figure 20). The register and bit controls also show all bit fields for the selected register. Change the values by using the **Clock Select** dropdown menu (Label 35 in Figure 20) or by selecting or clearing the **Single Cycle Mode** check box (Label 36 in Figure 20).

Documentation

The **Documentation** area (Label 38 in Figure 20) contains the documentation for the register or the bit field selected. This field can be updated by selecting a register or bit field in the register list, or by hovering over the register or bit field in the register list or register control. To display the **Documentation** area in a separate window, click **Expand** (Label 37 in Figure 20).

Save and Load

Save and **Load** (Label 39 in Figure 20) allow the user to save the current register map setting to a file and to load the setting from the same file, respectively. The **Export** button exports the register settings as a header file that is compatible with the **AD411x no operating system software drivers**, which allows the user to quickly save their preferred configuration for prototyping use.

EXITING THE SOFTWARE

To exit the software, click the close button in the title bar.

EVALUATION BOARD SCHEMATICS AND ARTWORK

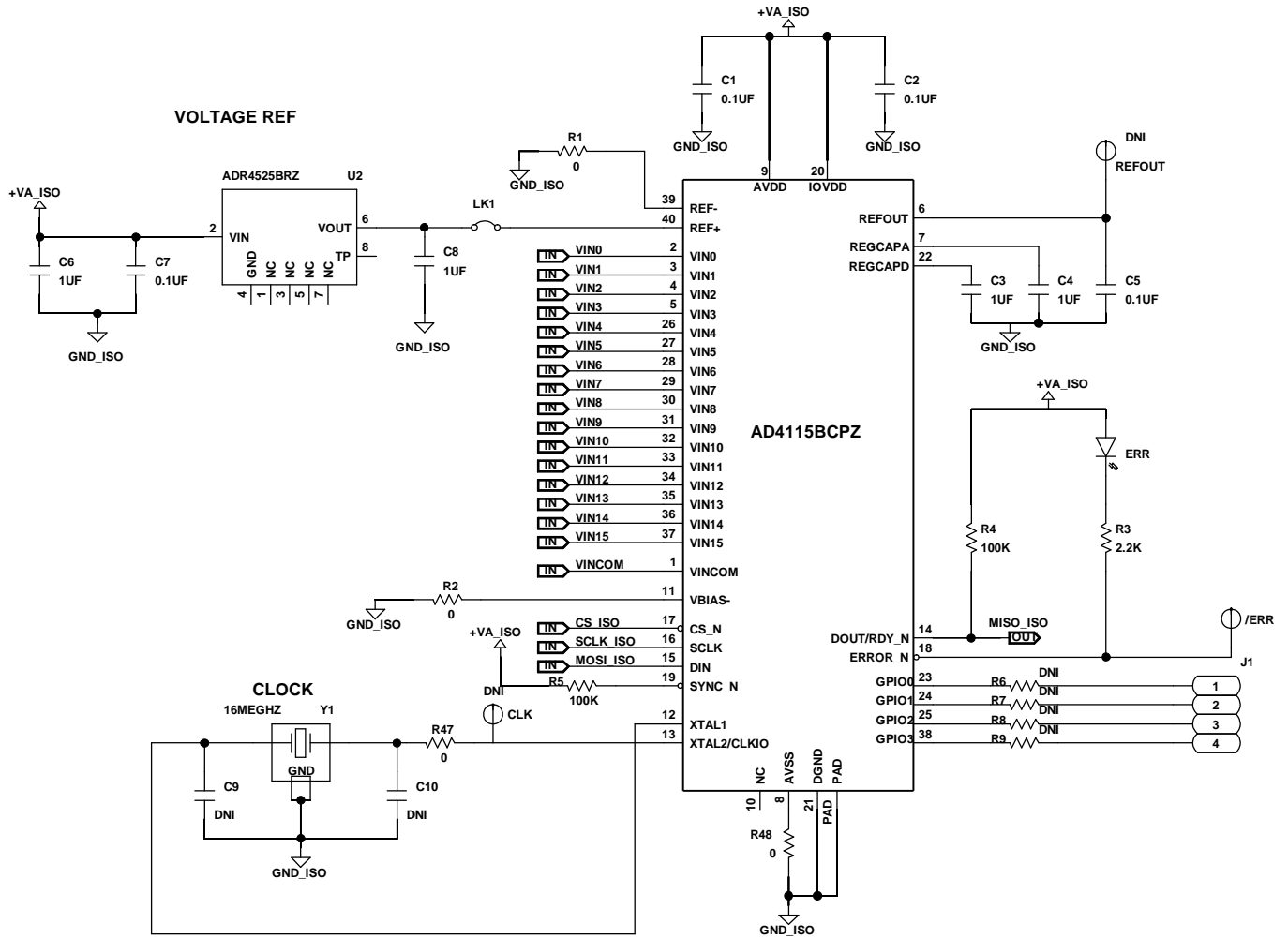

Figure 21. AD4115 Schematic

23/989-021

LK9 AND LK10 CAN BE REMOVED TO DISCONNECT THE TVS DIODE FROM THE SIGNAL INPUT PATH
 LK11 AND LK12 CAN BE INSERTED TO BYPASS THE RESISTOR
 THIS ALLOWS THE ADC TO BE EVALUATED DIRECTLY

INPUT PROTECTION

INPUT PROTECTION CIRCUITY ARE BASED OFF AN EMC ROBUSTNESS DESIGN. MORE DETAILS CAN BE FOUND IN AN-1572

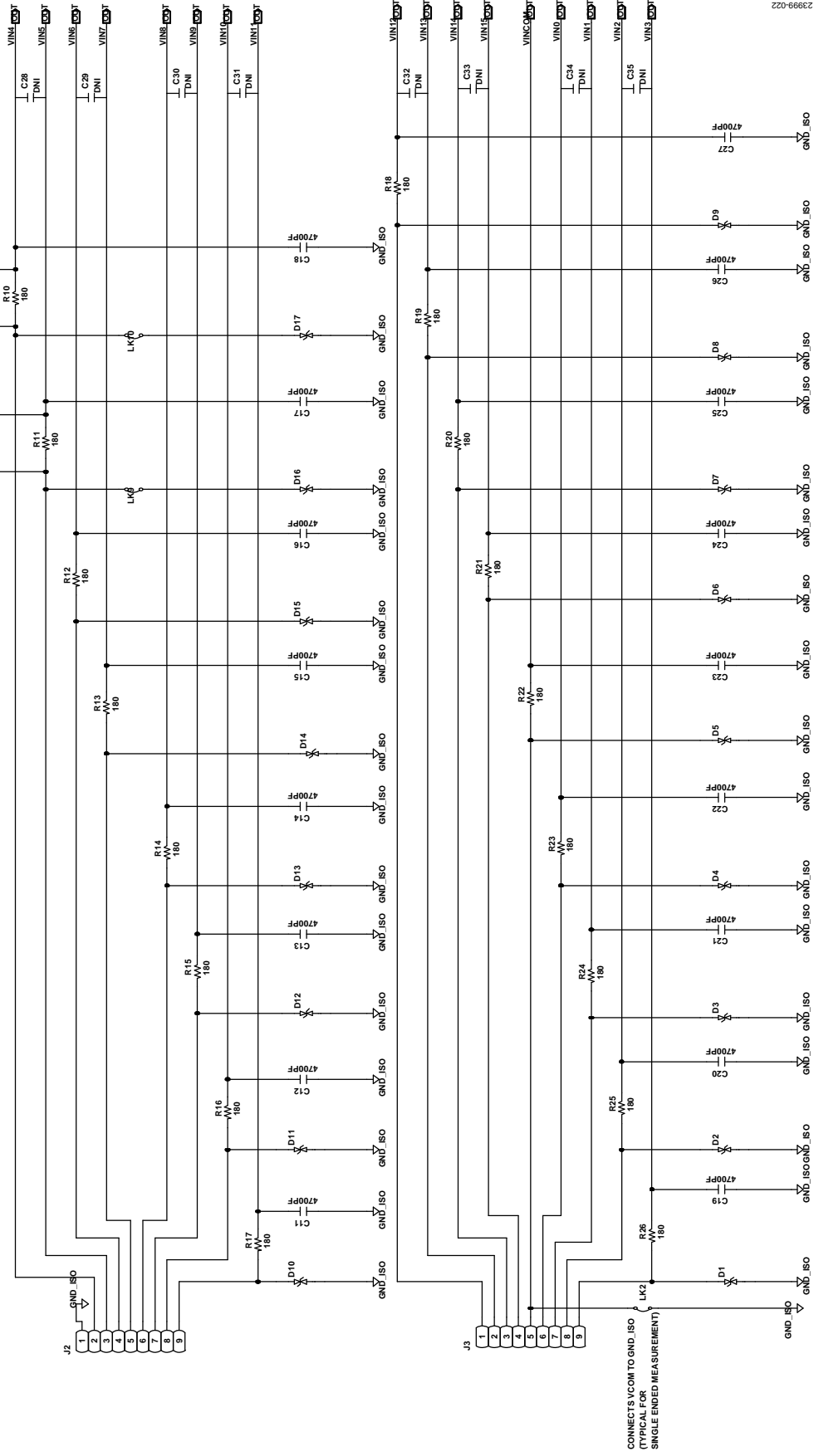

Figure 22. Voltage Input Front End Schematic
 Rev. 0 | Page 18 of 24

23999-023

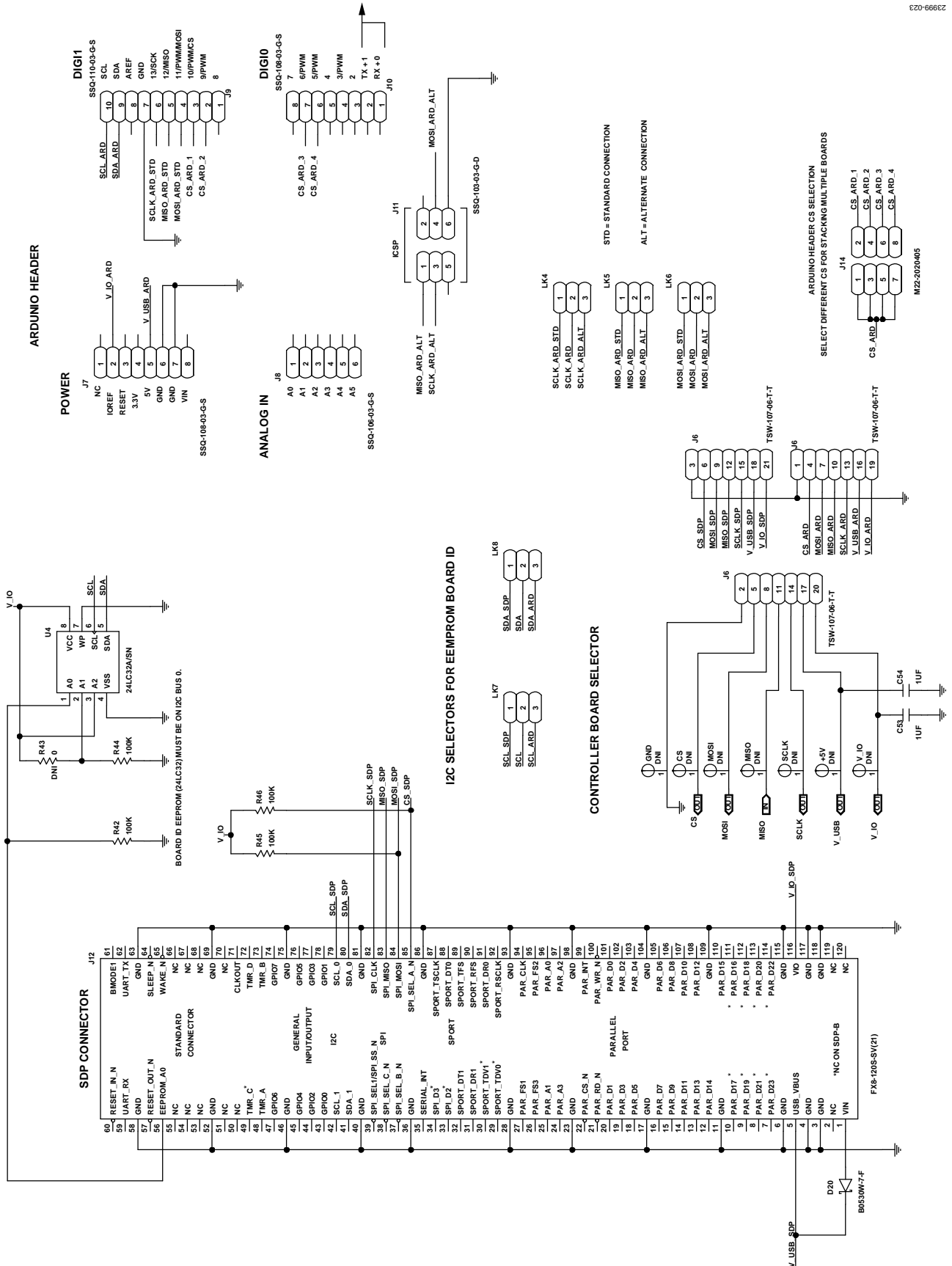

Figure 23. SDP and Arduino Connector Schematic

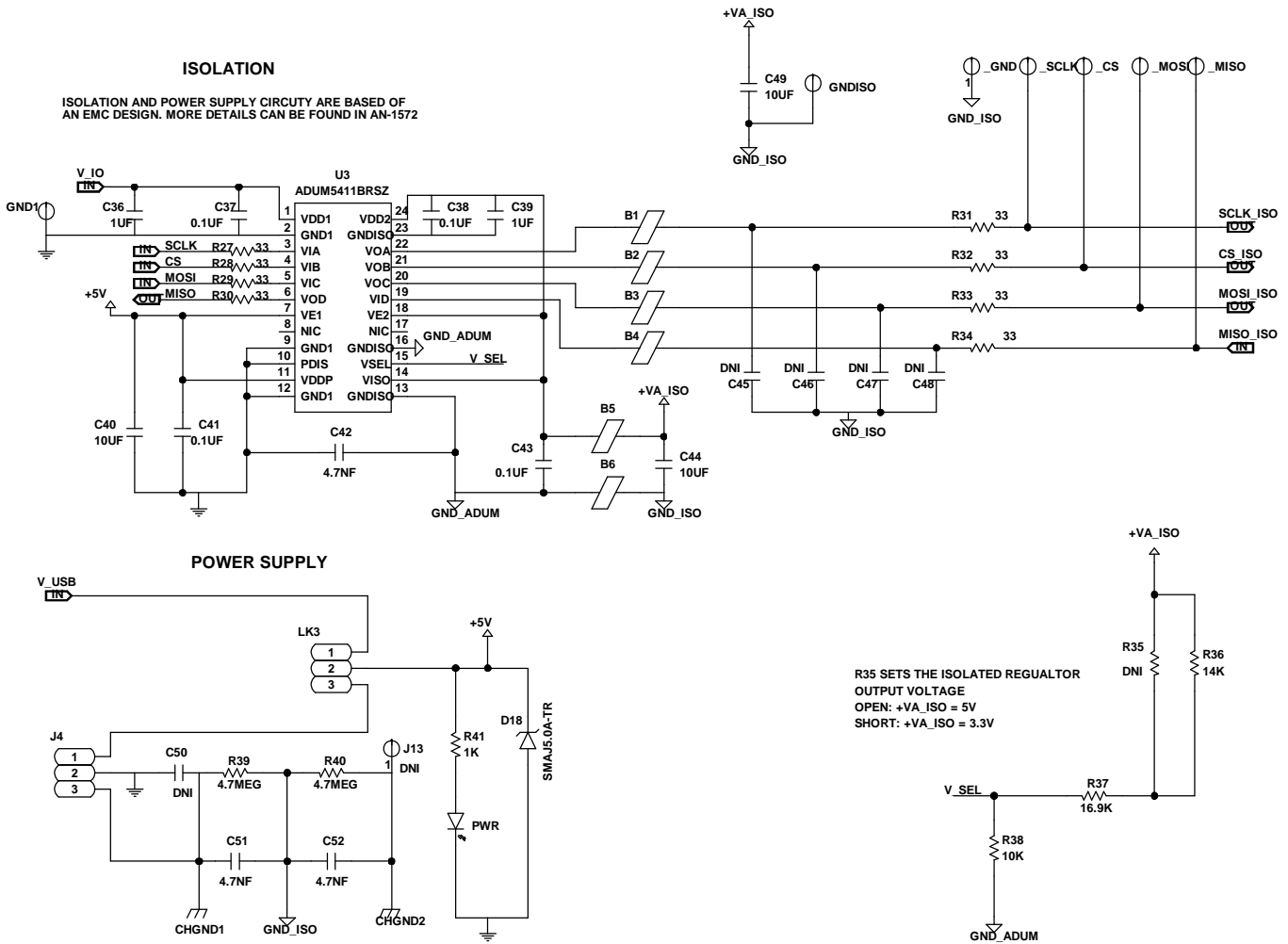
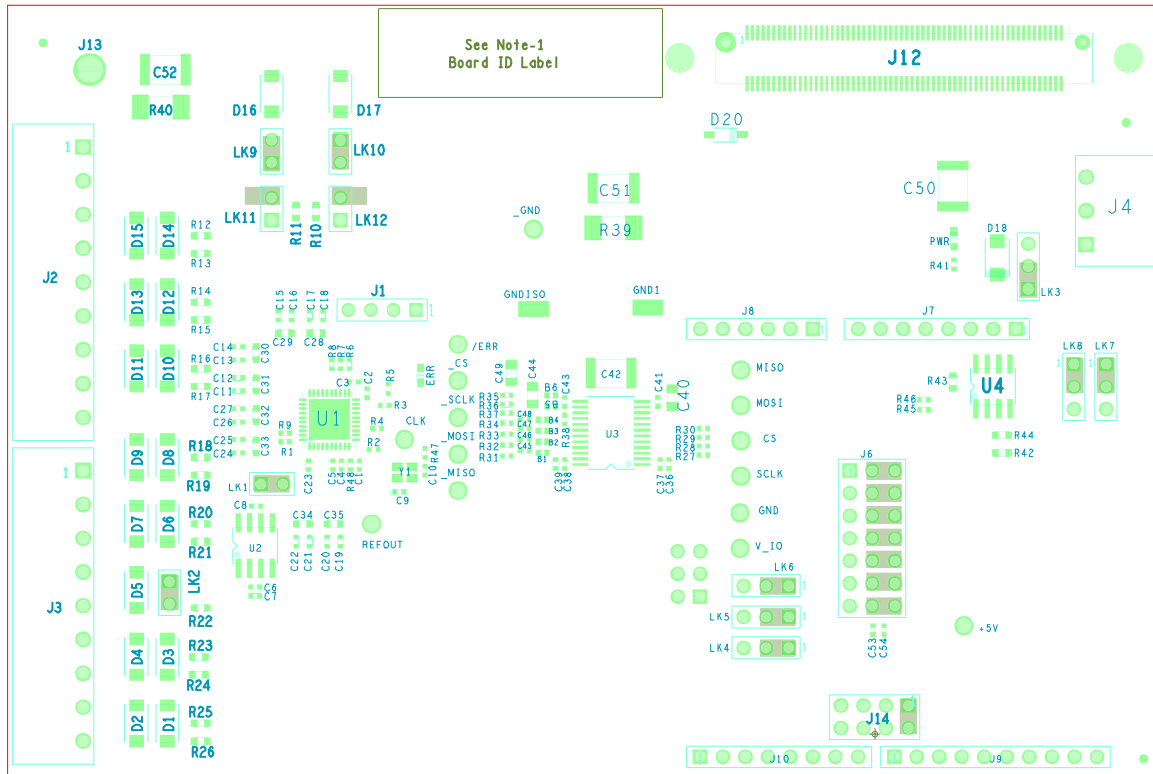

Figure 24. Insulation and Power Supply Schematic

23999-024



23989-025

Figure 25. Top Printed Circuit Board (PCB)

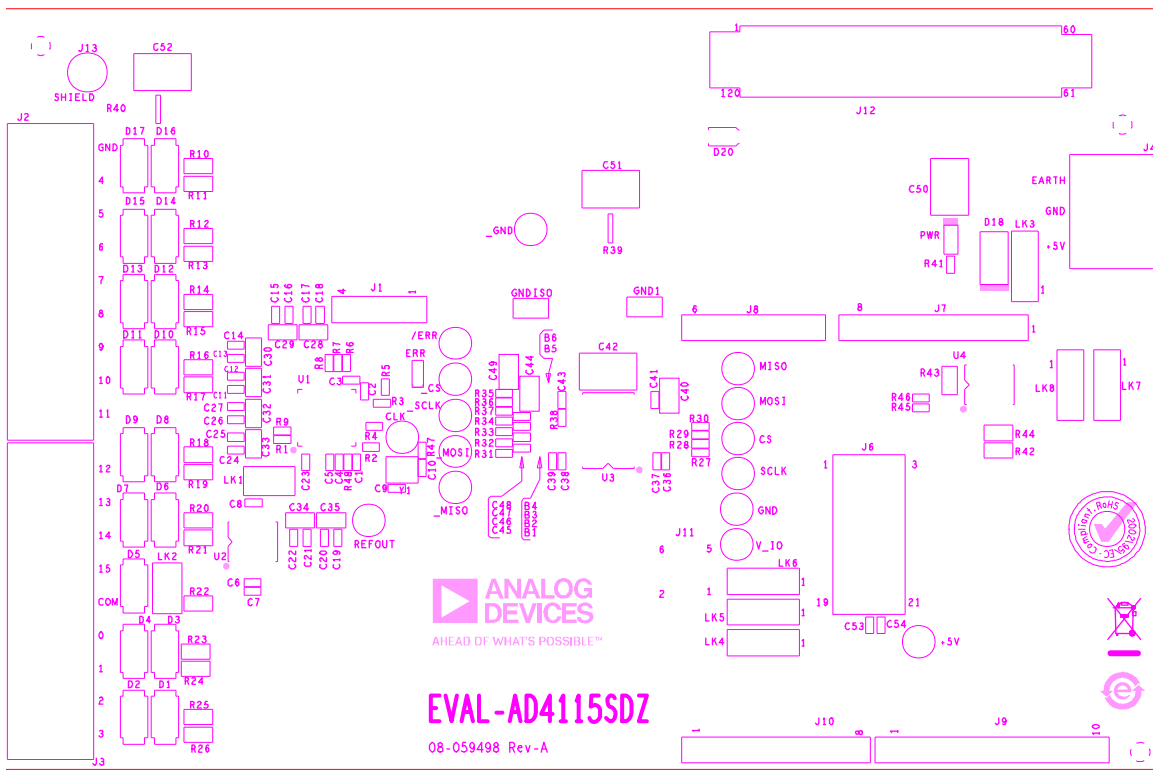

23989-026

Figure 26. Component Side Silkscreen Top

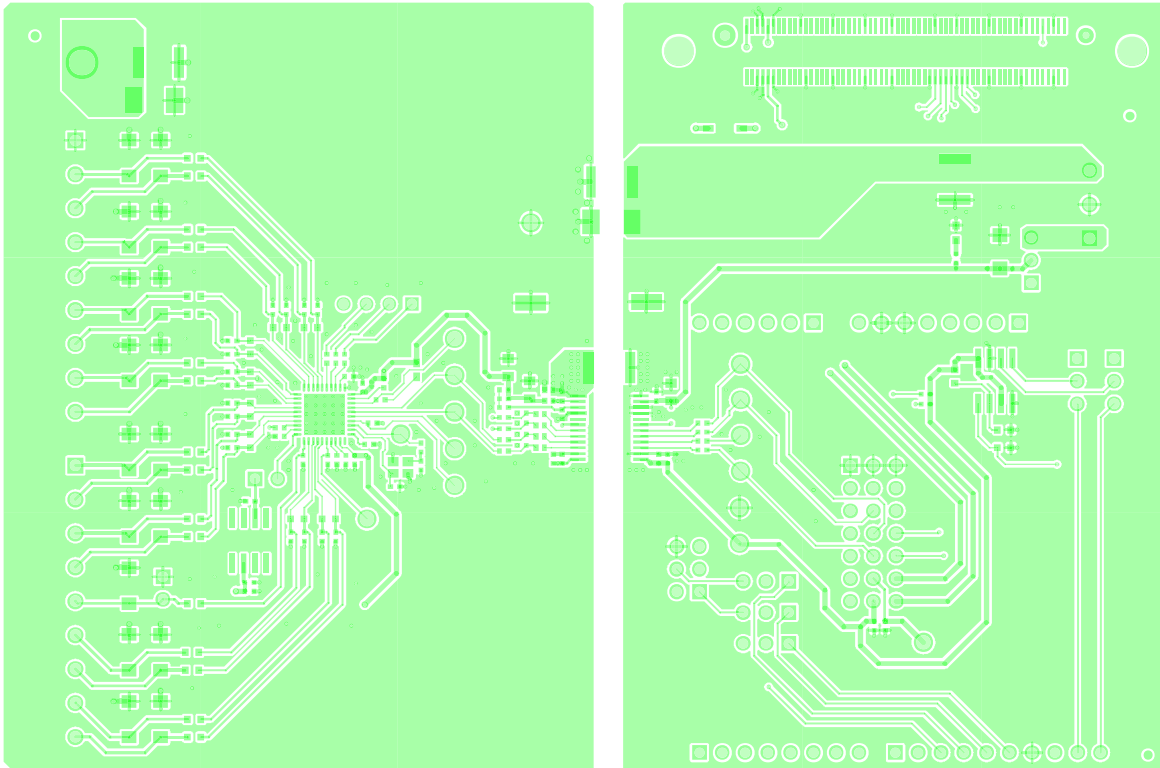

Figure 27. Layer 1, Component Side

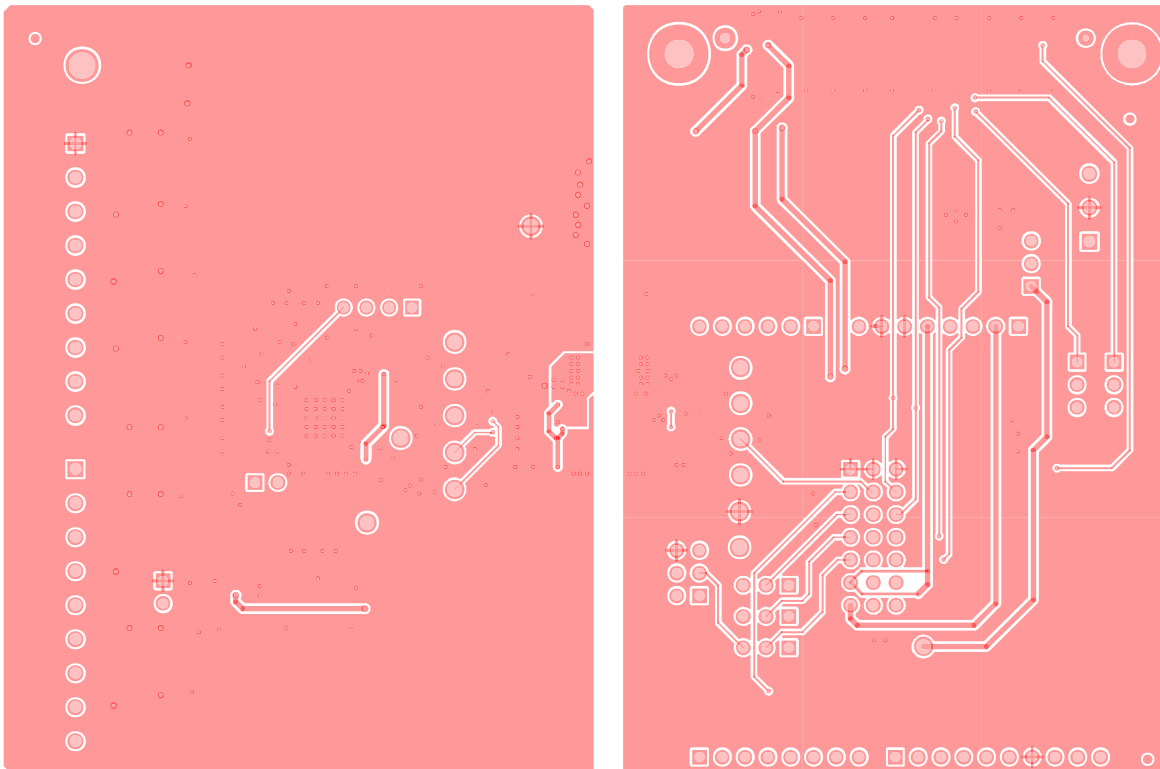

Figure 28. Layer 2, Solder Side

ORDERING INFORMATION

BILL OF MATERIALS

Table 3. Bill of Materials

Reference Designator	Description	Manufacturer	Part Number
B1 to B6	B0402, 1800 Ω at 100 MHz, 200 mA	Murata	BLM15HD182SN1D
C1, C2, C5, C7, C37, C38, C41, C43	C0402, 0.1 μF capacitors, 16 V X7R	Murata	GCM155R71C104KA55D
C3, C4, C6, C8, C36, C39, C53, C54	C0402, 1 μF capacitors, 16 V, X5R	Taiyo Yuden	EMK105BJ105KV-F
C9, C10	C0402, do not insert (DNI) capacitors	Not applicable	Not applicable
C28 to C35	C0603, DNI capacitors	Not applicable	Not applicable
C40, C44, C49	C0805, 10 μF capacitors, 10 V, X7R	Würth Elektronik	885012207026
C42, C51, C52	C1812, 4.7 nF capacitors, 2 kV, X7R	Murata	GR443DR73D472KW01L
C50	C0402, 470 pF capacitor, 50 V, C0G/NP0	Not applicable	Not applicable
D1 to D17	Diodes, TVS bipolar, 33 V, 400 W	STMicroelectronics	SMAJ33CA
D18	Diode, TVS unipolar, 5 V, 400 W	STMicroelectronics	SMAJ5.0A
D20	Diode, Schottky, 30 V, 0.5 A, SOD123	Diodes, Inc.	B0530W-7-F
GND1, GNDISO	SMT test points	Keystone	5015
ERR	Light emitting diode (LED), 0603, red	Vishay	TLMS1000-GS08
J1	4-pin header, 2.54 mm pitch	Harwin	M20-9990445
J2, J3	Connectors, headers, 90°, 9-position, 3.81 mm	Phoenix Contact	1803345
J4	Power socket block, 3-way, 3.81 mm pitch	Phoenix Contact	1803280
J6	21-pin, 3 row, header, 2.54 mm pitch	Samtec	TSW-107-06-T-T
J7, J10	8-position receptacle connectors, 2.54 mm pitch	Samtec	SSQ-108-03-G-S
J8	6-position receptacle connector, 2.54 mm pitch	Samtec	SSQ-106-03-G-S
J9	10-position receptacle connector, 2.54 mm pitch	Samtec	SSQ-110-03-G-S
J11	6-position, 2 row, receptacle connector, 2.54 mm pitch	Samtec	SSQ-103-03-G-D
J12	120-way connector, 0.6 mm pitch	HRS	FX8-120S-SV(21)
J13	Test point, DNI	Not applicable	Not applicable
J14	8-position, 2 row, header, 2.54 mm pitch	Samtec	TLW-104-05-T-D
LK1, LK2	2-pin headers, 2.54 mm pitch	Harwin	M20-9990246
LK3	3-pin header, 2.54 mm pitch	Harwin	M20-9990346 M7566-05
LK4 to LK8	3-pin headers, 2.54 mm pitch	Samtec	TLW-103-05-G-S
LK9 to LK12	3-pin headers, 2.54 mm pitch	Samtec	TSW-101-07-G-D
PWR	LED, green, surface mount device (SMD), 20 mA, 2.2 V, 560 nm	Rohm Semiconductor	SML-D12P8WT86
R1, R2, R47, R48	Resistors, 0402, 1%, 0 Ω	Multicomp	MC00625W040210R
R3	Resistor, 2.2 kΩ, 0.063 W, 1%, 0402	Panasonic	ERJ-2GEJ222X
R4, R5, R45, R46	Resistors, 100 kΩ, 0.063 W, 1%, 0402	Multicomp	MC00625W04021100K
R6 to R9, R35	Resistors, DNI, 0402	Not applicable	Not applicable
R10 to R26	Resistors, 180 Ω, 0.1 W, 1%, 0603	Multicomp	MCWR06X1800FTL
R27 to R34	Resistors, 33 Ω, 0.1 W, 5%, 0402	Panasonic	ERJ-2GEJ330X
R36	Resistor, 14 kΩ, 0.063 W, 1%, 0402	Vishay	CRCW040214K0FKED
R37	Resistor, 16.9 kΩ, 0.1 W, 1%, 0402	Panasonic	ERJ-2RKF1692X
R38	Resistor, 10 kΩ, 0.063 W, 1%, 0402	Vishay	CRCW040210K0FKED
R39, R40	Resistors, 4.7 MΩ, 0.5 W, 5%, 2010	Bourns	CHV2010-JW-475ELF
R41	Resistor, 1 kΩ, 0.063 W, 5%, 0402	Yageo	RC0402JR-071KL
R42, R44	Resistors, 100 kΩ, 0.063 W, 1%, 0603	Multicomp	MC0063W06031100K
R43	Resistor, DNI, 0402	Bourns	CHV2010-JW-475ELF

Reference Designator	Description	Manufacturer	Part Number
U1	Single-supply, 24-bit, sigma-delta ADC with ± 10 V inputs	Analog Devices	AD4115SDZ
U2	2.5 V voltage reference, ± 4 ppm/ $^{\circ}$ C $\pm 0.04\%$	Analog Devices	ADR4525ARZ
U3	Digital isolator, 4-channel, <i>isoPower</i>	Analog Devices	ADuM5411BRSZ
U4	32 kb I ² C serial EEPROM	Microchip	24LC32A/SN
Y1	16 MHz, miniature crystal, SMD	Epson Toyocom	Q24FA20H00044

I²C refers to a communications protocol originally developed by Philips Semiconductors (now NXP Semiconductors).



ESD Caution

ESD (electrostatic discharge) sensitive device. Charged devices and circuit boards can discharge without detection. Although this product features patented or proprietary protection circuitry, damage may occur on devices subjected to high energy ESD. Therefore, proper ESD precautions should be taken to avoid performance degradation or loss of functionality.

Legal Terms and Conditions

By using the evaluation board discussed herein (together with any tools, components documentation or support materials, the "Evaluation Board"), you are agreeing to be bound by the terms and conditions set forth below ("Agreement") unless you have purchased the Evaluation Board, in which case the Analog Devices Standard Terms and Conditions of Sale shall govern. Do not use the Evaluation Board until you have read and agreed to the Agreement. Your use of the Evaluation Board shall signify your acceptance of the Agreement. This Agreement is made by and between you ("Customer") and Analog Devices, Inc. ("ADI"), with its principal place of business at One Technology Way, Norwood, MA 02062, USA. Subject to the terms and conditions of the Agreement, ADI hereby grants to Customer a free, limited, personal, temporary, non-exclusive, non-sublicensable, non-transferable license to use the Evaluation Board FOR EVALUATION PURPOSES ONLY. Customer understands and agrees that the Evaluation Board is provided for the sole and exclusive purpose referenced above, and agrees not to use the Evaluation Board for any other purpose. Furthermore, the license granted is expressly made subject to the following additional limitations: Customer shall not (i) rent, lease, display, sell, transfer, assign, sublicense, or distribute the Evaluation Board; and (ii) permit any Third Party to access the Evaluation Board. As used herein, the term "Third Party" includes any entity other than ADI, Customer, their employees, affiliates and in-house consultants. The Evaluation Board is NOT sold to Customer; all rights not expressly granted herein, including ownership of the Evaluation Board, are reserved by ADI. CONFIDENTIALITY. This Agreement and the Evaluation Board shall all be considered the confidential and proprietary information of ADI. Customer may not disclose or transfer any portion of the Evaluation Board to any other party for any reason. Upon discontinuation of use of the Evaluation Board or termination of this Agreement, Customer agrees to promptly return the Evaluation Board to ADI. ADDITIONAL RESTRICTIONS. Customer may not disassemble, decompile or reverse engineer chips on the Evaluation Board. Customer shall inform ADI of any occurred damages or any modifications or alterations it makes to the Evaluation Board, including but not limited to soldering or any other activity that affects the material content of the Evaluation Board. Modifications to the Evaluation Board must comply with applicable law, including but not limited to the RoHS Directive. TERMINATION. ADI may terminate this Agreement at any time upon giving written notice to Customer. Customer agrees to return to ADI the Evaluation Board at that time. LIMITATION OF LIABILITY. THE EVALUATION BOARD PROVIDED HEREUNDER IS PROVIDED "AS IS" AND ADI MAKES NO WARRANTIES OR REPRESENTATIONS OF ANY KIND WITH RESPECT TO IT. ADI SPECIFICALLY DISCLAIMS ANY REPRESENTATIONS, ENDORSEMENTS, GUARANTEES, OR WARRANTIES, EXPRESS OR IMPLIED, RELATED TO THE EVALUATION BOARD INCLUDING, BUT NOT LIMITED TO, THE IMPLIED WARRANTY OF MERCHANTABILITY, TITLE, FITNESS FOR A PARTICULAR PURPOSE OR NON-INFRINGEMENT OF INTELLECTUAL PROPERTY RIGHTS. IN NO EVENT WILL ADI AND ITS LICENSORS BE LIABLE FOR ANY INCIDENTAL, SPECIAL, INDIRECT, OR CONSEQUENTIAL DAMAGES RESULTING FROM CUSTOMER'S POSSESSION OR USE OF THE EVALUATION BOARD, INCLUDING BUT NOT LIMITED TO LOST PROFITS, DELAY COSTS, LABOR COSTS OR LOSS OF GOODWILL. ADI'S TOTAL LIABILITY FROM ANY AND ALL CAUSES SHALL BE LIMITED TO THE AMOUNT OF ONE HUNDRED US DOLLARS (\$100.00). EXPORT. Customer agrees that it will not directly or indirectly export the Evaluation Board to another country, and that it will comply with all applicable United States federal laws and regulations relating to exports. GOVERNING LAW. This Agreement shall be governed by and construed in accordance with the substantive laws of the Commonwealth of Massachusetts (excluding conflict of law rules). Any legal action regarding this Agreement will be heard in the state or federal courts having jurisdiction in Suffolk County, Massachusetts, and Customer hereby submits to the personal jurisdiction and venue of such courts. The United Nations Convention on Contracts for the International Sale of Goods shall not apply to this Agreement and is expressly disclaimed.