



### Typical Applications

Low noise MMIC VCO w/Divide-by-16 for:

- VSAT Radio
- Point to Point/Multipoint Radio
- Test Equipment & Industrial Controls
- Military End-Use
- Automotive Radar

### Features

- Pout: +12 dBm
- Phase Noise: -95 dBc/Hz @100 KHz Typ.
- No External Resonator Needed
- Single Supply: +5V @ 220 mA
- 24 Lead 4x4mm QFN Package: 9 mm<sup>2</sup>

### Functional Diagram

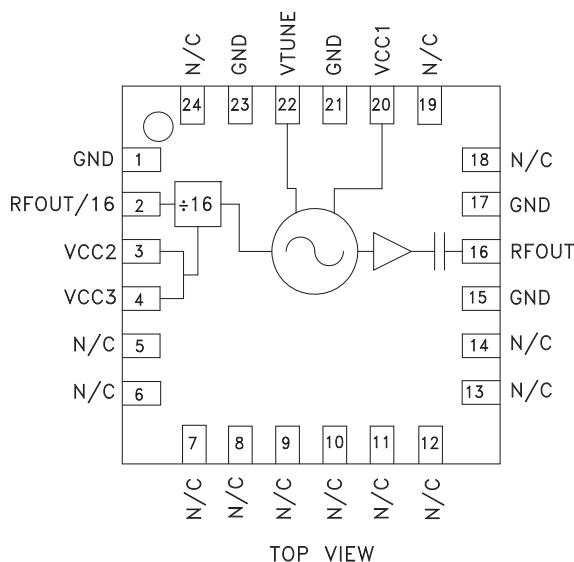

### General Description

The HMC533LP4 & HMC533LP4E are GaAs InGaP Heterojunction Bipolar Transistor (HBT) MMIC VCOs. The HMC533LP4 & HMC533LP4E integrate resonators, negative resistance devices, varactor diodes and feature a divide-by-16 output. The VCO's phase noise performance is excellent over temperature, shock, and process due to the oscillator's monolithic structure. Power output is +12 dBm typical from a +5V supply voltage. Prescaler function can be disabled to conserve current if not required. The voltage controlled oscillator is packaged in a leadless QFN 4 x 4 mm surface mount package.

### Electrical Specifications, $T_A = +25^\circ C$ , $V_{cc1}$ , $V_{cc2}$ , $V_{cc3} = +5V$

Parameter	Min.	Typ.	Max.	Units	
Frequency Range	23.8 - 24.8			GHz	
Power Output	RFOUT +9	+12	+15	dBm	
	RFOUT/16 -7	-4	-1	dBm	
SSB Phase Noise @ 100 kHz Offset, $V_{tune} = +5V$ @ RFOUT		-95		dBc/Hz	
Tune Voltage	$V_{tune}$	2	13	V	
Supply Current	$I_{cc}$	180	220	260	mA
Tune Port Leakage Current ( $V_{tune} = 13V$ )			10	$\mu A$	
Output Return Loss		3		dB	
Harmonics/Subharmonics	1/2	26		dBc	
	3/2	37		dBc	
Pulling (into a 2.0:1 VSWR)		13		MHz/pp	
Pushing @ $V_{tune} = 5V$		80		MHz/V	
Frequency Drift Rate		2.3		MHz/ $^\circ C$	

Information furnished by Analog Devices is believed to be accurate and reliable. However, no responsibility is assumed by Analog Devices for its use, nor for any infringements of patents or other rights of third parties that may result from its use. Specifications subject to change without notice. No license is granted by implication or otherwise under any patent or patent rights of Analog Devices. Trademarks and registered trademarks are the property of their respective owners.

For price, delivery, and to place orders: Analog Devices, Inc., One Technology Way, P.O. Box 9106, Norwood, MA 02062-9106  
Phone: 781-329-4700 • Order online at [www.analog.com](http://www.analog.com)  
Application Support: Phone: 1-800-ANALOG-D

# HMC533\* PRODUCT PAGE QUICK LINKS

Last Content Update: 11/29/2017

---

## COMPARABLE PARTS

View a parametric search of comparable parts.

## EVALUATION KITS

- HMC533LP4 Evaluation Board.

## DOCUMENTATION

### Data Sheet

- HMC533 Data Sheet

## REFERENCE MATERIALS

### Product Selection Guide

- RF, Microwave, and Millimeter Wave IC Selection Guide 2017

### Quality Documentation

- Package/Assembly Qualification Test Report: LP4, LP4B, LP4C, LP4K (QTR: 2013-00487 REV: 04)
- Package/Assembly Qualification Test Report: Plastic Encapsulated QFN (QTR: 05006 REV: 02)
- Semiconductor Qualification Test Report: GaAs HBT-A (QTR: 2013-00228)

## DESIGN RESOURCES

- HMC533 Material Declaration
- PCN-PDN Information
- Quality And Reliability
- Symbols and Footprints

## DISCUSSIONS

View all HMC533 EngineerZone Discussions.

## SAMPLE AND BUY

Visit the product page to see pricing options.

## TECHNICAL SUPPORT

Submit a technical question or find your regional support number.

## DOCUMENT FEEDBACK

Submit feedback for this data sheet.

---

This page is dynamically generated by Analog Devices, Inc., and inserted into this data sheet. A dynamic change to the content on this page will not trigger a change to either the revision number or the content of the product data sheet. This dynamic page may be frequently modified.



**Frequency vs. Tuning Voltage, T= 25°C**

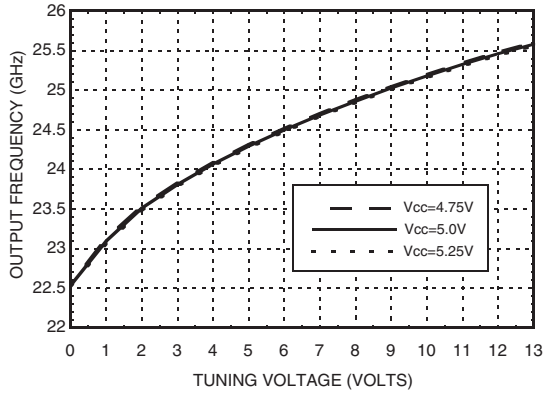

**Frequency vs. Tuning Voltage, Vcc= +5V**

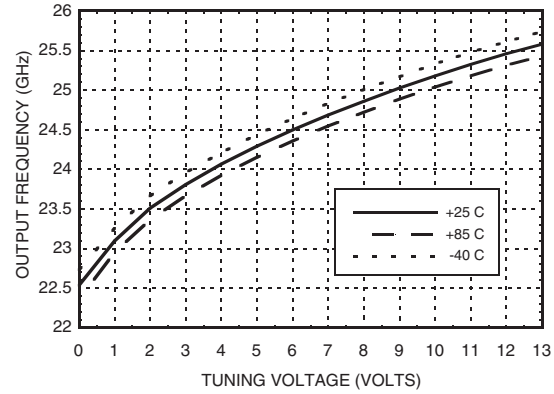

**Sensitivity vs. Tuning Voltage, Vcc= +5V**

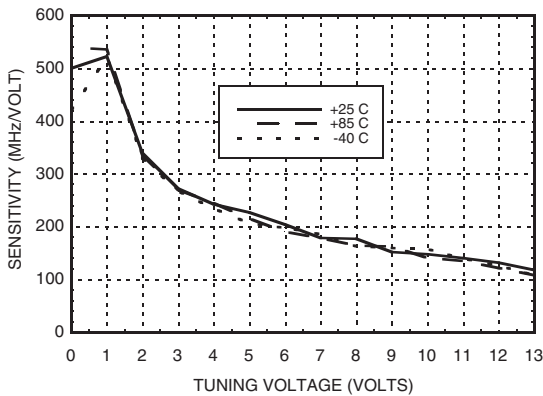

**Output Power vs. Tuning Voltage, Vcc= +5V**

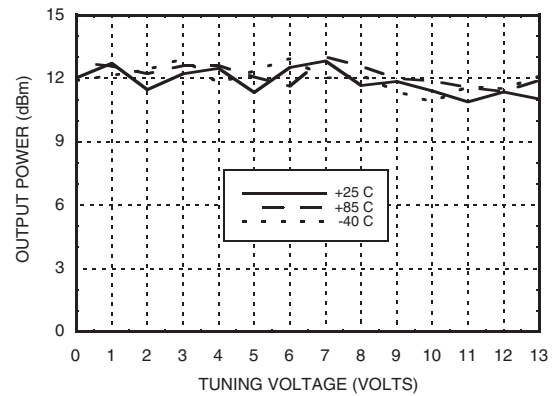

Information furnished by Analog Devices is believed to be accurate and reliable. However, no responsibility is assumed by Analog Devices for its use, nor for any infringements of patents or other rights of third parties that may result from its use. Specifications subject to change without notice. No license is granted by implication or otherwise under any patent or patent rights of Analog Devices. Trademarks and registered trademarks are the property of their respective owners.

For price, delivery, and to place orders: Analog Devices, Inc., One Technology Way, P.O. Box 9106, Norwood, MA 02062-9106 Phone: 781-329-4700 • Order online at [www.analog.com](http://www.analog.com) Application Support: Phone: 1-800-ANALOG-D



**SSB Phase Noise vs. Tuning Voltage**

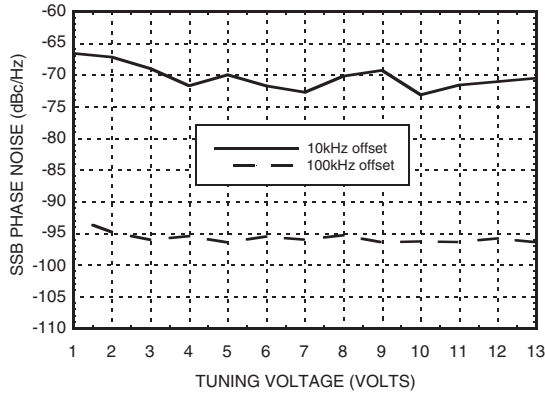

**SSB Phase Noise @ Vtune= +5V**

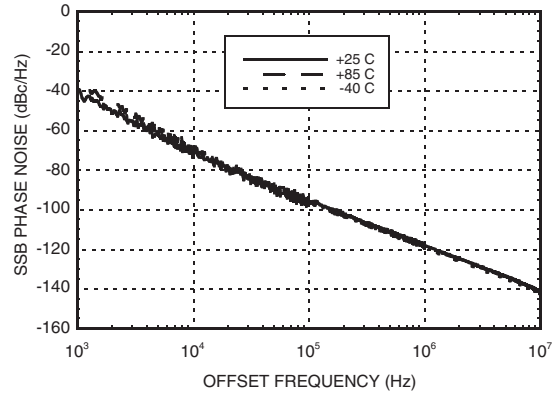

**Divide-by-16 Frequency vs. Tuning Voltage, Vcc= +5V**

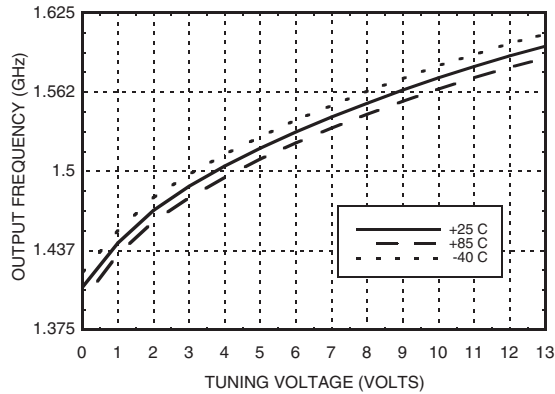

**Divide-by-16 Output Power vs. Tuning Voltage, Vcc= +5V**

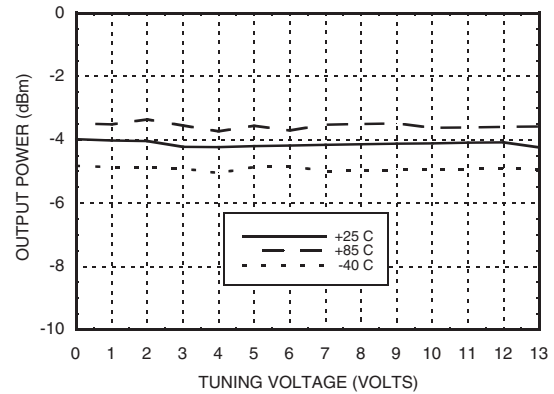

**Absolute Maximum Ratings**

Vcc1, Vcc2	5.5 V
Vtune	0 to 15V Max.
Junction Temperature	135 °C
Continuous Pdiss (T=85 °C) (derate 28 mW/C above 85 °C)	1.4 W
Thermal Resistance	36 °C/W
Storage Temperature	-65 to +150 °C
Operating Temperature	-40 to +85 °C
ESD Sensitivity (HBM)	Class 1A

**Typical Supply Current vs. Vcc**

Vcc (V)	Icc (mA)
4.75	200
5.0	220
5.25	240

Note: VCO will operate over full voltage range shown above.



**ELECTROSTATIC SENSITIVE DEVICE  
OBSERVE HANDLING PRECAUTIONS**

Information furnished by Analog Devices is believed to be accurate and reliable. However, no responsibility is assumed by Analog Devices for its use, nor for any infringements of patents or other rights of third parties that may result from its use. Specifications subject to change without notice. No license is granted by implication or otherwise under any patent or patent rights of Analog Devices. Trademarks and registered trademarks are the property of their respective owners.

For price, delivery, and to place orders: Analog Devices, Inc., One Technology Way, P.O. Box 9106, Norwood, MA 02062-9106 Phone: 781-329-4700 • Order online at [www.analog.com](http://www.analog.com) Application Support: Phone: 1-800-ANALOG-D



### Outline Drawing

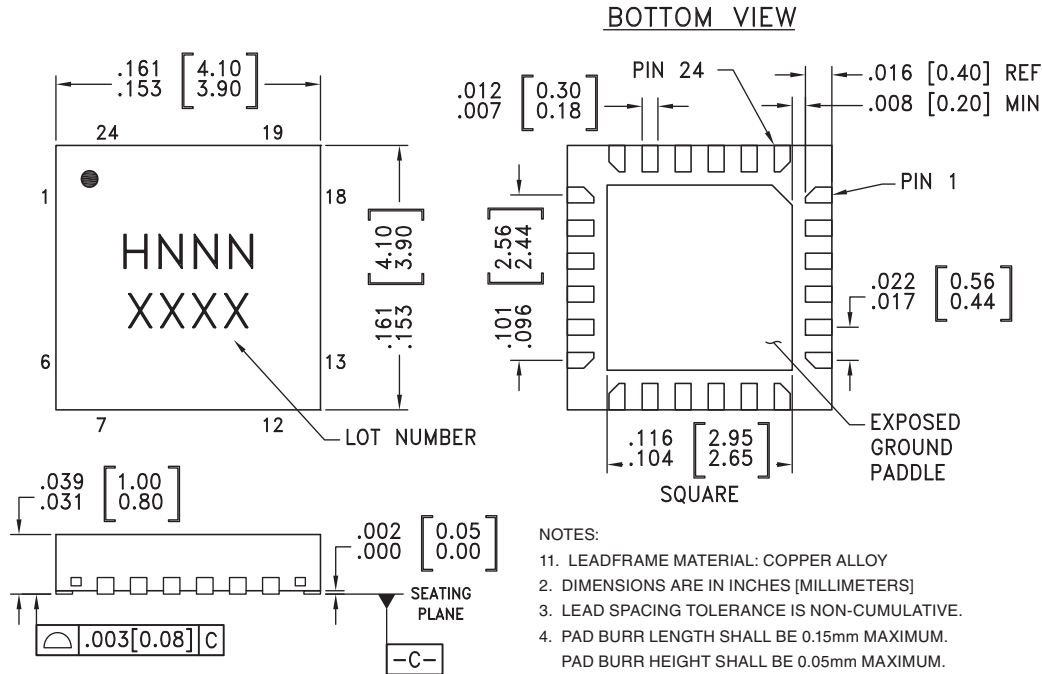

### Package Information

Part Number	Package Body Material	Lead Finish	MSL Rating	Package Marking <sup>[3]</sup>
HMC533LP4	Low Stress Injection Molded Plastic	Sn/Pb Solder	MSL1 <sup>[1]</sup>	H533 XXXX
HMC533LP4E	RoHS-compliant Low Stress Injection Molded Plastic	100% matte Sn	MSL1 <sup>[2]</sup>	H533 XXXX

[1] Max peak reflow temperature of 235 °C  
 [2] Max peak reflow temperature of 260 °C  
 [3] 4-Digit lot number XXXX

### Pin Descriptions

Pin Number	Function	Description	Interface Schematic
1, 15, 17, 21, 23	GND	Package bottom has an exposed metal paddle that must also be connected to RF/DC ground.	
2	RFOUT/16	Divided-by-16 Output	



**Pin Descriptions**

Pin Number	Function	Description	Interface Schematic
3, 4	VCC2, VCC3	Supply voltage for prescaler. If prescaler is not required, these pins may be left open to conserve 100 mA of current	
5-14, 18, 19, 24	N/C	No Connection. These pins may be connected to RF/DC ground. Performance will not be affected.	
16	RFOUT	RF output (AC coupled).	
20	VCC1	Supply Voltage, +5V	
22	VTUNE	Control Voltage Input. Modulation port bandwidth dependent on drive source impedance.	

**Typical Application Circuit**

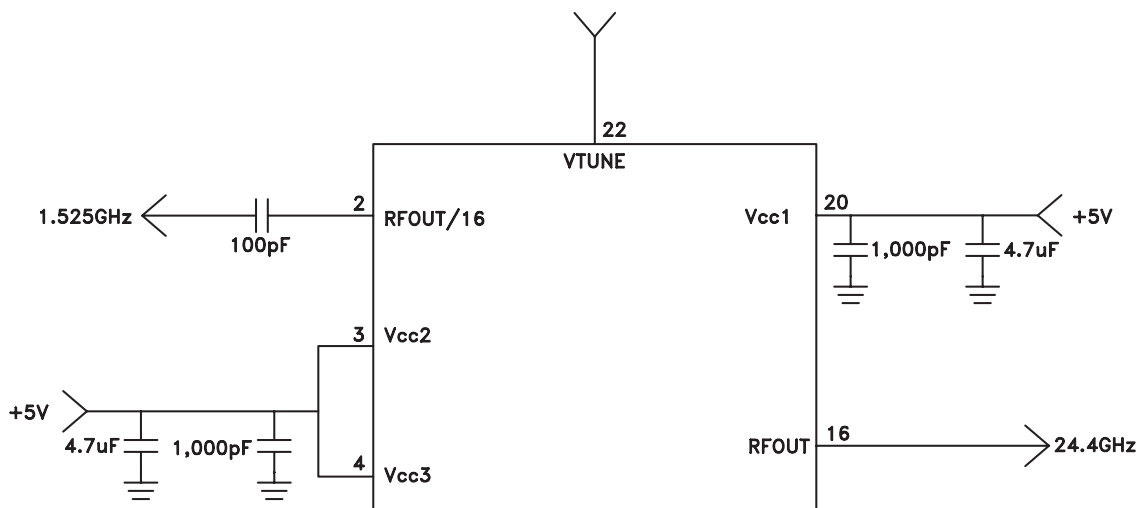

Information furnished by Analog Devices is believed to be accurate and reliable. However, no responsibility is assumed by Analog Devices for its use, nor for any infringements of patents or other rights of third parties that may result from its use. Specifications subject to change without notice. No license is granted by implication or otherwise under any patent or patent rights of Analog Devices. Trademarks and registered trademarks are the property of their respective owners.

For price, delivery, and to place orders: Analog Devices, Inc., One Technology Way, P.O. Box 9106, Norwood, MA 02062-9106 Phone: 781-329-4700 • Order online at [www.analog.com](http://www.analog.com) Application Support: Phone: 1-800-ANALOG-D



**Evaluation PCB**

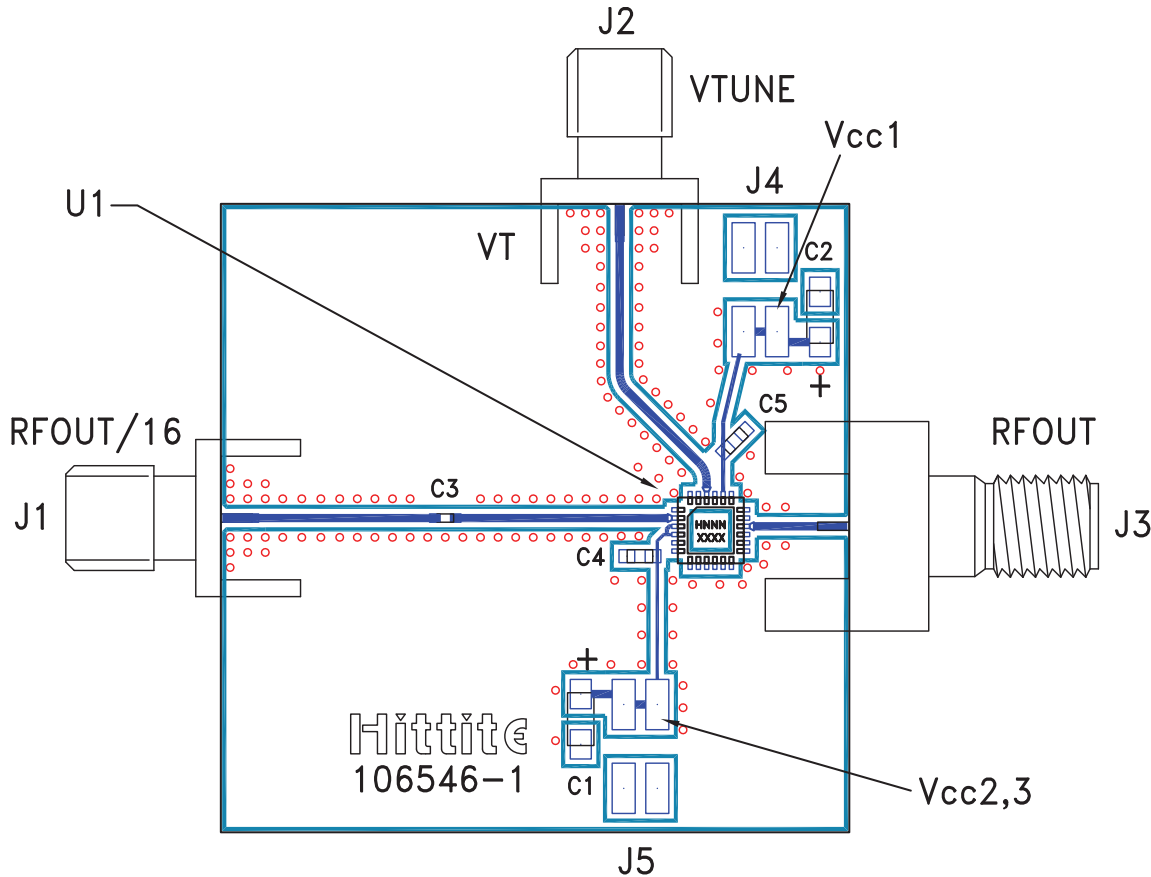

**List of Materials for Evaluation PCB 106651 [1]**

Item	Description
J1 - J2	PCB Mount SMA RF Connector
J3	2.92 mm PCB mount k-connector
J4 - J5	2 mm DC Header
C1 - C2	4.7 μF Tantalum Capacitor
C3	100 pF Capacitor, 0402 Pkg.
C4 - C5	1,000 pF Capacitor, 0603 Pkg.
U1	HMC533LP4 / HMC533LP4E VCO
PCB [2]	106546 Eval Board

[1] Reference this number when ordering complete evaluation PCB

[2] Circuit Board Material: Rogers 4350

The circuit board used in the final application should use RF circuit design techniques. Signal lines should have 50 ohm impedance while the package ground leads and backside ground slug should be connected directly to the ground plane similar to that shown. A sufficient number of via holes should be used to connect the top and bottom ground planes. The evaluation circuit board shown is available from Hittite upon request.