

**Circuits from the Lab®**  
Reference Designs

Circuits from the Lab® reference designs are engineered and tested for quick and easy system integration to help solve today's analog, mixed-signal, and RF design challenges. For more information and/or support, visit [www.analog.com/CN0314](http://www.analog.com/CN0314).

### Devices Connected/Referenced

|        |  |
|--------|--|
| AD8420 | Wide Supply Range, Rail-to-Rail Output Instrumentation Amplifier |
| ADR02  | Ultracompact, Precision 5.0V Voltage Reference                   |
|        |  |

## Configurable 4-20 mA Loop Powered Transmitter/Receiver using a Micropower Instrumentation Amplifier

### EVALUATION AND DESIGN SUPPORT

#### Circuit Evaluation Boards

[CN0314 Evaluation Board \(EVAL-CN0314-EB1Z\)](#)

#### Design and Integration Files

[Schematics, Layout Files, Bill of Materials](#)

### CIRCUIT FUNCTION AND BENEFITS

The circuit shown in Figure 1 is a configurable 4 mA-to-20 mA loop-powered transmitter based on an industry-leading micropower instrumentation amplifier. Total unadjusted error is less than 1%. It can be configured with a single switch as either a transmitter (Figure 1) that converts a differential input voltage into a current output, or as a receiver (Figure 5) that converts a 4 mA-to-20 mA current input to a voltage output.

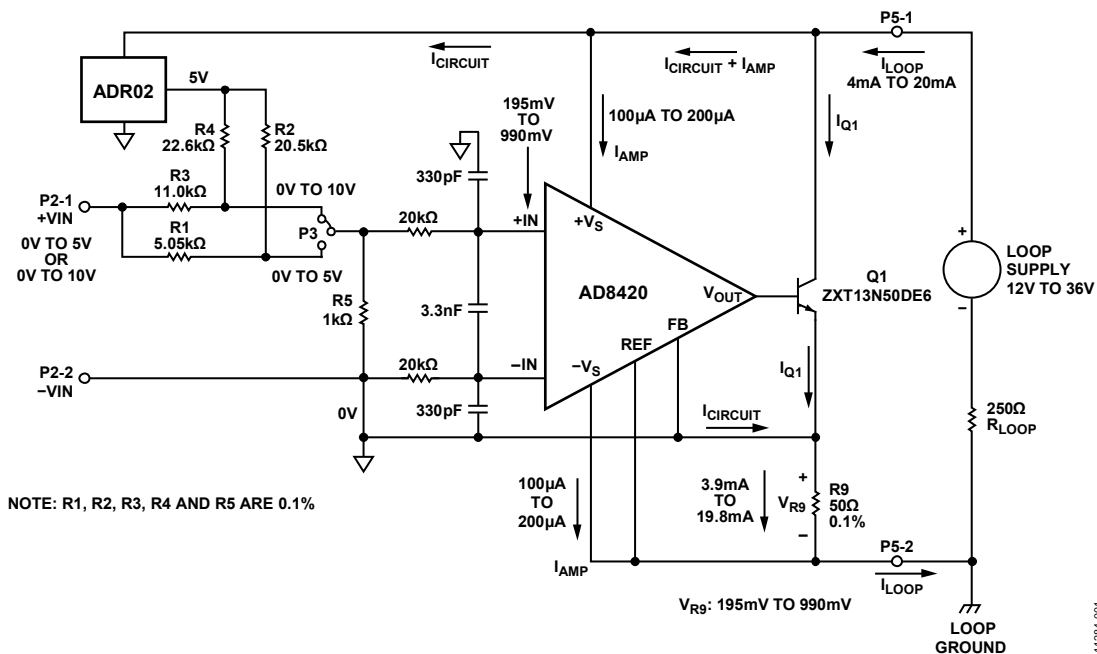

Figure 1. Robust Loop Powered Configurable Transmitter Circuit with 4 mA-to-20 mA Output

11284-001

#### Rev. 0

Circuits from the Lab® reference designs from Analog Devices have been designed and built by Analog Devices engineers. Standard engineering practices have been employed in the design and construction of each circuit, and their function and performance have been tested and verified in a lab environment at room temperature. However, you are solely responsible for testing the circuit and determining its suitability and applicability for your use and application. Accordingly, in no event shall Analog Devices be liable for direct, indirect, special, incidental, consequential or punitive damages due to any cause whatsoever connected to the use of any Circuits from the Lab circuits. (Continued on last page)

One Technology Way, P.O. Box 9106, Norwood, MA 02062-9106, U.S.A.  
Tel: 781.329.4700 [www.analog.com](http://www.analog.com)  
Fax: 781.461.3113 ©2014 Analog Devices, Inc. All rights reserved.

The design is optimized for precision, low noise and low power industrial process control applications. The circuit can accept 0 V to 5V or 0 V to 10 V input range as a transmitter. As a receiver it can provide 0.2 V to 2.3 V or 0.2 V to 4.8 V output range compatible with ADCs using 2.5 V or 5 V references. The supply voltage can range from 12 V to 36 V as a transmitter and 7 V to 36 V as a receiver.

Since the circuit is configurable, a single hardware design can be used as a backup for both transmitter and receiver at the same time, minimizing customer inventory requirements.

## CIRCUIT DESCRIPTION

The circuit features the [AD8420](#), an instrumentation amplifier based on an indirect current feedback architecture. Because of this architecture, the [AD8420](#) has excellent input and output characteristics. Unlike conventional instrumentation amplifiers, the [AD8420](#) can easily amplify signals at or even slightly below ground without requiring dual supplies. The [AD8420](#) has rail-to-rail output voltage swing that is completely independent of the input common-mode voltage. This exempts the [AD8420](#) from the restrictions caused by interaction between the common-mode input and output voltage associated with most conventional instrumentation amplifier architectures. The flexible input and output characteristics, together with micropower consumption (80  $\mu$ A maximum for 0 V input) and wide supply range, make the [AD8420](#) ideal for flexible low power industrial applications.

### Transmitter Configuration

Figure 1 shows the simplified schematic for the 4mA-to-20mA transmitter configuration. The circuit only consumes around 1 mA of current, which makes it suitable for loop-powered applications. The transmitter has input ranges of 0 V to 5 V and 0 V to 10 V, which can be selected using Jumper P3. The input voltage range is then scaled down to 0.195 V to 0.990 V range since the differential input voltage of [AD8420](#) is limited to maximum of 1 V.

The input to the [AD8420](#) has a differential mode noise filter (40 k $\Omega$ /3.3 nF) with a 1.2 kHz bandwidth and a common-mode noise filter (20 k $\Omega$ /330 pF) with a 24 kHz bandwidth.

The indirect current feedback architecture of [AD8420](#) forces the differential input voltage of the amplifier to appear between its FB and REF pins. The transistor Q1 then translates the 0.195 V to 0.990 V range into 3.9 mA to 19.8 mA flowing through the R9 50  $\Omega$  sense resistor.

The current through the R9 sense resistor includes the circuit current and the Q1 current, but not the [AD8420](#) current,  $I_{AMP}$ .

The unique architecture of the [AD8420](#) makes its supply current predictable from 100  $\mu$ A to 200  $\mu$ A for a 0.195 V to 0.990 V input applied between +IN and -IN. This supply current will add to the current through R9, bringing the total output loop current to 4 mA-to-20 mA. Therefore, the total current in the loop is given by the equation:

$$I_{LOOP} = I_{AMP} + I_{R9}$$

In order for the circuit to operate properly, the total circuit supply voltage must be greater than 7 V to provide sufficient headroom for the [ADR02](#) voltage reference.

$$V_{LOOP SUPPLY} > 7 \text{ V} + R_{LOAD} I_{Loop(max)}$$

For  $R_{LOOP}$  of 250  $\Omega$ ,

$$V_{LOOP SUPPLY} > 7 \text{ V} + (250 \Omega)(20 \text{ mA})$$

Therefore,

$$V_{LOOP SUPPLY} > 12 \text{ V}$$

The loop supply voltage is also limited to 36 V maximum.

An advantage of [AD8420](#) is its high impedance reference pin that eliminates the need for an additional op-amp to drive it, thus, saving power, cost and space in the transmitter circuit.

It is important for proper loop operation that the circuit board ground and the loop ground are not connected except for the R9, 50  $\Omega$  sense resistor.

### Selection of Scaling Resistors

The differential input voltage range of [AD8420](#) is limited to maximum of  $\pm 1$  V. Hence, to be able to accept higher industrial input voltage range, the circuit makes use of a scaling resistor network to translate the 0 V to 5 V or 0 V to 10 V input into 0.195 V to 0.990 V. The following equations use nodal analysis to obtain the values for R1, R2, R3, and R4 in the circuit:

$$\frac{V_{IN_{MIN}} - 0.195 \text{ V}}{R1} + \frac{V_{REF} - 0.195 \text{ V}}{R2} = \frac{0.195 \text{ V}}{R5} \quad (1)$$

$$\frac{V_{IN_{MAX}} - 0.990 \text{ V}}{R1} + \frac{V_{REF} - 0.990 \text{ V}}{R2} = \frac{0.990 \text{ V}}{R5} \quad (2)$$

where:

$$V_{REF} = 5 \text{ V}$$

$$R5 = 1 \text{ k}\Omega$$

For 0 V to 5 V input range, Equation 1 and Equation 2 lead to Equation 3 and Equation 4, respectively.

$$\frac{0 \text{ V} - 0.195 \text{ V}}{R1} + \frac{5 \text{ V} - 0.195 \text{ V}}{R2} = \frac{0.195 \text{ V}}{1 \text{ k}\Omega} \quad (3)$$

$$\frac{5 \text{ V} - 0.990 \text{ V}}{R1} + \frac{5 \text{ V} - 0.990 \text{ V}}{R2} = \frac{0.990 \text{ V}}{1 \text{ k}\Omega} \quad (4)$$

Solving for R1 and R2 using Equation 3 and Equation 4:

$$R1 = 5044 \Omega$$

$$R2 = 20564 \Omega$$

For 0 V to 10 V input range, Equation 1 and Equation 2 results to Equation 5 and Equation 6, respectively.

$$\frac{0 \text{ V} - 0.195 \text{ V}}{R3} + \frac{5 \text{ V} - 0.195 \text{ V}}{R4} = \frac{0.195 \text{ V}}{1 \text{ k}\Omega} \quad (5)$$

$$\frac{10 \text{ V} - 0.990 \text{ V}}{R3} + \frac{5 \text{ V} - 0.990 \text{ V}}{R4} = \frac{0.990 \text{ V}}{1 \text{ k}\Omega} \quad (6)$$

Again, solving for the corresponding scaling resistors:

$$R3 = 11088 \Omega$$

$$R4 = 22603 \Omega$$

In the practical circuit, the nearest EIA standard 0.1% resistor values must be chosen, resulting in fixed offset error. The resistors supplied with the [EVAL-CN0314-EB1Z](#) board are as follows:

$$R1 = 5050 \Omega \text{ and } R2 = 20500 \Omega$$

$$R3 = 11000 \Omega \text{ and } R4 = 22600 \Omega$$

With these values supplied with the board, the offset errors due to the resistor values can be computed using the following equations:

For 0 V to 5 V inputs,  $V_{REF} = 5 \text{ V}$ ,  $R1 = 5.05 \text{ k}\Omega$ ,  $R2 = 20.5 \text{ k}\Omega$ , and  $R5 = 1 \text{ k}\Omega$ .

$$\text{Offset Error (\%FSR)} =$$

$$\left[ \frac{(R1)(R2)(R5) \left( \frac{V_{IN}}{R1} + \frac{V_{REF}}{R2} \right)}{[(R1)(R2) + (R2)(R5) + (R1)(R5)]50\Omega} - IQ1(\text{ideal}) \right] \times 100\% \quad (7)$$

$$\text{Offset Error (\%FSR)} = 0.078\% \text{ at } V_{IN} = 0 \text{ V; } IQ1 = 3.9 \text{ mA}$$

$$\text{Offset Error (\%FSR)} = -0.033\% \text{ at } V_{IN} = 5 \text{ V; } IQ1 = 19.8 \text{ mA}$$

Consequently, for 0 V to 10 V inputs,  $V_{REF} = 5 \text{ V}$ ,  $R3 = 11 \text{ k}\Omega$ ,  $R4 = 22.6 \text{ k}\Omega$ , and  $R5 = 1 \text{ k}\Omega$ :

$$\text{Offset Error (\%FSR)} =$$

$$\left[ \frac{(R3)(R4)(R5) \left( \frac{V_{IN}}{R3} + \frac{V_{REF}}{R4} \right)}{[(R3)(R4) + (R4)(R5) + (R3)(R5)]50\Omega} - IQ1(\text{ideal}) \right] \times 100\% \quad (8)$$

$$\text{Offset Error (\%FSR)} = -0.013\% \text{ at } V_{IN} = 0 \text{ V; } IQ1 = 3.9 \text{ mA}$$

$$\text{Offset Error (\%FSR)} = 0.718\% \text{ at } V_{IN} = 10 \text{ V; } IQ1 = 19.8 \text{ mA}$$

To minimize this offset error, it is also possible to use combination of two 0.1% values to come closer to the calculated resistor values.

### Total Transmitter Circuit Accuracy

A good approximation of the total error contributed by the resistor tolerances is to assume that each of the critical resistors contributes equally to the total error. The four critical resistors are R1 or R3, R2 or R4, R5 and R9. Worst-case tolerance build up of 0.1% resistors yield a total resistor error of 0.4% maximum. If rss errors are assumed, the total rss error is  $0.1\sqrt{4} = 0.2\%$ .

The maximum and rss errors due to the active components in the system using the A grade for [AD8420](#) and B grade for levels of [ADR02](#) are shown in the table below.

**Table 1. Errors Due to Active Components**

| Error Component | Error  | Error Value       | Error %FSR |
|-----------------|--------|-------------------|------------|
| AD8420-A        | Offset | 250 $\mu\text{V}$ | 0.03%      |
| ADR02-B         | Offset | 0.06%             | 0.015%     |
| RSS FS Error    |        |                   | 0.034%     |
| Max FS Error    |        |                   | 0.045%     |

Adding the worst case resistor tolerance error of 0.4% to the worst-case errors due to the offsets of active components yields:

$$\text{Full Scale Error} = 0.4\% + 0.045\% = 0.445\%$$

These errors assume that ideal resistors were selected and the errors resulted from their tolerances.

Actual error data from the circuit is shown in Figure 3 and Figure 4 with a loop supply = 25 V. The total output error (%FSR) is calculated by taking the difference between the measured output current and the ideal output current, dividing by the FSR (16 mA), and multiplying the result by 100.

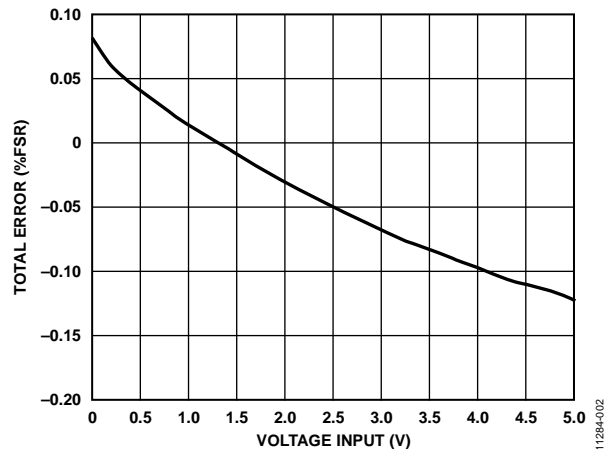

Figure 2. Total Transmitter Error (%FSR) vs. Input Voltage (0 V to 5 V Range)

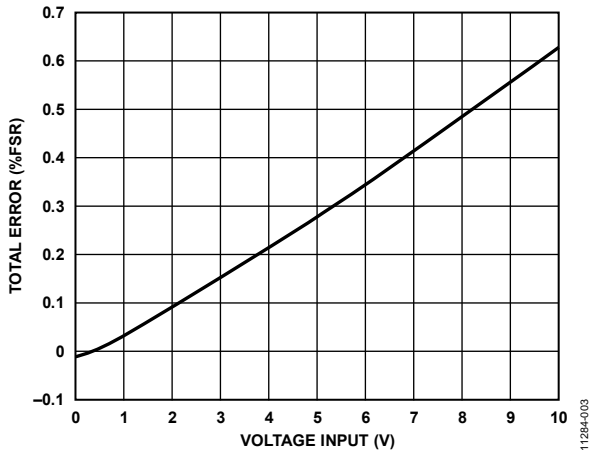
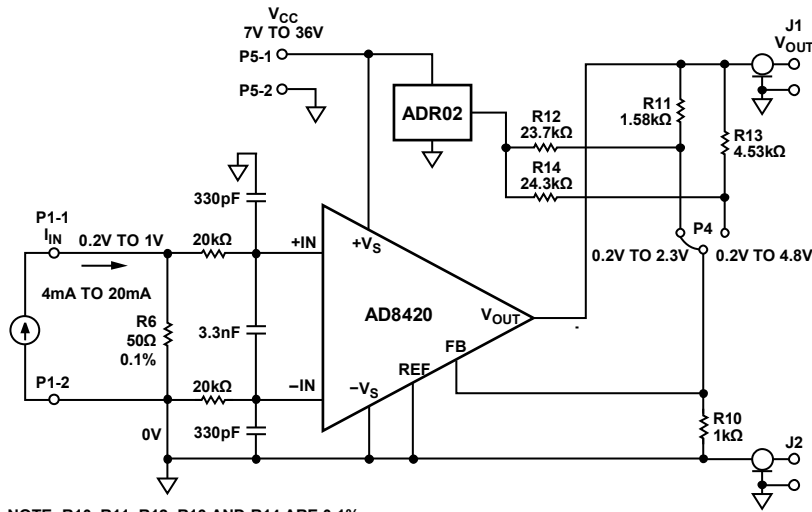

Figure 3. Total Transmitter Error (%FSR) vs. Input Voltage (0V to 10V Range)

**Receiver Configuration**

The simplified receiver configuration is illustrated in Figure 4. The receiver circuit translates the current signal into a voltage level that is compatible with most single-ended input ADCs operating on either 2.5 V or 5 V references.



NOTE: R10, R11, R12, R13 AND R14 ARE 0.1%

Figure 4. Simplified Schematic for 4 mA-to-20 mA Receiver Configuration

Resistor R6 is used to sense the 4 mA-to-20 mA signal and convert it into a 0.2 V to 1 V input voltage to the amplifier. The input voltage is then reflected across the FB and REF pins of the amplifier. Unlike most direct-gain receivers with an output voltage range of 1 V to 5 V, the circuit uses the [ADR02](#) together with gain and scaling resistors to provide an output of 0.2 V to 4.8 V. This maximizes the input dynamic range of ADCs with 5 V references. The extra headroom ensures linearity across the entire input signal range. The receiver circuit can also be configured using Jumper P4 to give an output of 0.2 V to 2.3 V for ADCs that use 2.5 V references.

The key advantage of [AD8420](#) for this application is that it can sense the current near ground without exceeding the input range or running into common-mode restrictions, unlike many other single supply instrumentation amplifiers. Additionally, the [AD8420](#) provides gain and level shifting capability so that it does not waste ADC input range as would be the case with simple resistive dividers.

### Selection of Gain and Scaling Resistors

The gain of the [AD8420](#) is usually set by the ratio of two resistors (R11 and R10). However, the circuit utilizes [ADR02](#) to take advantage of the extra 20% of the range that is wasted with direct gain on the low side. The equations below show how to get the value of the gain and scaling resistors for the desired output voltage ranges.

$$\frac{V_{OUT\_MIN} - 0.200 \text{ V}}{R11} + \frac{V_{REF} - 0.200 \text{ V}}{R12} = \frac{0.200 \text{ V}}{R10} \quad (9)$$

$$\frac{V_{OUT\_MAX} - 1 \text{ V}}{R11} + \frac{V_{REF} - 1 \text{ V}}{R12} = \frac{1 \text{ V}}{R10} \quad (10)$$

where:

$$V_{REF} = 5 \text{ V}$$

$$R10 = 1 \text{ k}\Omega$$

For 0.2 V to 2.3 V output range:

$$\frac{0.2 \text{ V} - 0.200 \text{ V}}{R11} + \frac{5 \text{ V} - 0.200 \text{ V}}{R12} = \frac{0.200 \text{ V}}{1 \text{ k}\Omega} \quad (11)$$

$$\frac{2.3 \text{ V} - 1 \text{ V}}{R11} + \frac{5 \text{ V} - 1 \text{ V}}{R12} = \frac{1 \text{ V}}{1 \text{ k}\Omega} \quad (12)$$

This gives us resistor values of

$$R11 = 1560 \Omega$$

$$R12 = 24000 \Omega$$

For 0.2 V to 4.8 V output range,

$$\frac{0.2 \text{ V} - 0.200 \text{ V}}{R13} + \frac{5 \text{ V} - 0.200 \text{ V}}{R14} = \frac{0.200 \text{ V}}{1 \text{ k}\Omega} \quad (13)$$

$$\frac{4.8 \text{ V} - 1 \text{ V}}{R13} + \frac{5 \text{ V} - 1 \text{ V}}{R14} = \frac{1 \text{ V}}{1 \text{ k}\Omega} \quad (14)$$

Thus,

$$R13 = 4560 \Omega$$

$$R14 = 24000 \Omega$$

The resistor supplied on the circuit board is the value nearest EIA standard 0.1% resistor that is obtainable from and available with the suppliers. Thus, actual values of the resistor supplied on the board are as follows:

$$R11 = 1580 \Omega \text{ and } R12 = 23700 \Omega$$

$$R13 = 4530 \Omega \text{ and } R14 = 24300 \Omega$$

With these values supplied with the board, the offset errors due to the resistor values are as follows:

For a 0.2 V to 2.3 V output range,  $V_{REF} = 5 \text{ V}$ ,  $R11 = 1580 \Omega$ ,  $R12 = 23700 \Omega$ , and  $R10 = 1 \text{ k}\Omega$ .

Offset Error (%FSR) =

$$\left[ \frac{V_{FB} \left( 1 + \frac{R11}{R10} - \frac{R11}{R12} \right) - V_{REF} \left( \frac{R11}{R12} \right) - V_{OUT\_IDEAL}}{V_{OUT\_MAX} - V_{OUT\_MIN}} \right] \times 100\% \quad (15)$$

Offset Error (%FSR) = -0.190% at  $V_{FB} = 0.2 \text{ V}$ ;  $V_{OUT\_IDEAL} = 0.2 \text{ V}$

Offset Error (%FSR) = 0.635% at  $V_{FB} = 1 \text{ V}$ ;  $V_{OUT\_IDEAL} = 2.3 \text{ V}$

For a 0.2 V to 4.8 V output range,  $V_{REF} = 5 \text{ V}$ ,  $R13 = 4530 \Omega$ ,  $R14 = 24300 \Omega$ , and  $R10 = 1 \text{ k}\Omega$ .

Offset Error (%FSR) =

$$\left[ \frac{V_{FB} \left( 1 + \frac{R13}{R10} - \frac{R13}{R14} \right) - V_{REF} \left( \frac{R13}{R14} \right) - V_{OUT\_IDEAL}}{V_{OUT\_MAX} - V_{OUT\_MIN}} \right] \times 100\% \quad (16)$$

Offset Error (%FSR) = 0.243% at  $V_{FB} = 0.2 \text{ V}$ ;  $V_{OUT\_IDEAL} = 0.2 \text{ V}$

Offset Error (%FSR) = -0.341% at  $V_{FB} = 1 \text{ V}$ ;  $V_{OUT\_IDEAL} = 4.8 \text{ V}$

It is also possible to use combination of two 0.1% values to come closer to the calculated values minimize this offset error.

### Total Receiver Circuit Accuracy

A good approximation of the total error contributed by the resistor tolerances is to assume that each of the critical resistors contributes equally to the total error. The four critical resistors are R11 or R13, R12 or R14, R6 and R10. Worst-case tolerance build up of 0.1% resistors yield a total resistor error of 0.4% maximum. If rss errors are assumed, the total rss error is  $0.1\sqrt{4} = 0.2\%$ .

The maximum and rss errors due to the active components in the system using the A grade for AD8420 and B grade for levels of ADR02 are shown in the table below.

**Table 2. Errors Due to Active Components**

| Error Component | Error  | Error Value | Error % FSR |
|-----------------|--------|-------------|-------------|
| ADR02-B         | Offset | 0.06%       | 0.01%       |
| AD8420-A        | Offset | 250 $\mu$ V | 0.01%       |
| AD8420-A        | Gain   | 0.05%       | 0.05%       |
| RSS FS Offset   |        |             | 0.014%      |
| RSS FS Gain     |        |             | 0.05%       |
| RSS FS Error    |        |             | 0.064%      |
| Max FS Offset   |        |             | 0.02%       |
| Max FS Gain     |        |             | 0.05%       |
| Max FS Error    |        |             | 0.07%       |

Adding the worst case resistor tolerance error of 0.4% to the worst-case errors due to the active components yields:

$$\text{Full Scale Error} = 0.4\% + 0.07\% = 0.47\%$$

These errors assume that ideal resistors were selected, and the errors resulted from their tolerances.

Actual error data for the receiver circuit is shown in Figure 5 and Figure 6 with  $V_{CC} = 25$  V. The total output error (%FSR) is calculated by taking the difference between the measured output voltage and the ideal output current, dividing by the FSR of the output voltage, and multiplying the result by 100.

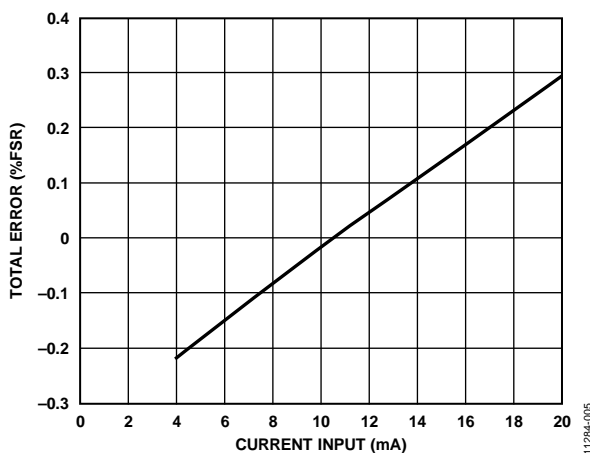

Figure 5. Total Receiver Error (%FSR) vs. Input Current (4 mA-to-20 mA Range) for 0.2 V to 2.3 V Output Range

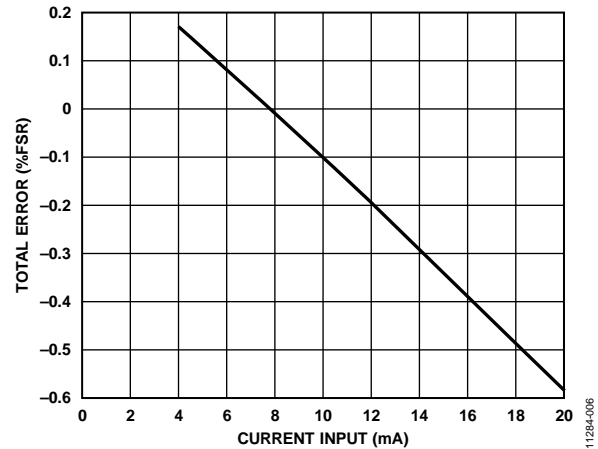

Figure 6. Total Receiver Error (%FSR) vs. Input Voltage (4 mA-to-20 mA Range) for 0.2 V to 4.8 V Output Range

A design support package for the EVAL-CN0314-EB1Z transmitter/receiver board including complete schematics, bill of materials, and layout files, can be found at <http://www.analog.com/CN0314-DesignSupport>.

## COMMON VARIATIONS

The circuit is proven to work with good stability and accuracy with component values shown. Other voltage references and in-amp can be used in this configuration for other various applications for this circuit.

The AD8237, a micropower, zero drift, true rail-to-rail instrumentation amplifier can also be used for low supply voltage versions of this circuit configuration.

The ADR4550, high precision, low power, low noise voltage references can be used to replace the ADR02 for a low voltage supply applications.

**CIRCUIT EVALUATION AND TEST**

**Equipment Required**

- EVAL-CN0314-EB1Z evaluation board
- Agilent E3631A dual dc power supply or equivalent
- Yokogawa 2000 precision dc power supply or equivalent
- Agilent 3458 precision multimeter or equivalent

**Test Setup Configuration and Tests**

The circuit was tested using the test setup shown in Figure 7 and Figure 8. The Agilent 3631A was set to 25 V to serve as the power supply of the board. The Agilent 3458 multimeter was used to measure the actual current or voltage output of the evaluation board. A photo of the EVAL-CN0314-EB1Z is shown in Figure 9.

For the test setup of the transmitter configuration (Figure 8), a Yokogawa 2000 precision dc source was used to generate a 0 V to 5 V or 0 V to 10 V differential input ranges. The S1 switch must be placed in the “V-I” position to configure the circuit as a transmitter



Figure 9. Photo of EVAL-CN0314-EB1Z Board

**Switch and Jumper Settings for 4 mA-to-20 mA Transmitter**

For the transmit configuration shown in Figure 1, Switch S1 should be put in the “V-I” position. Jumper P3 should be put in the “0-10V” position for an input range of 0 V to 10 V, and in the “0-5V” position for an input range of 0 V to 5 V. See also the photo of the evaluation board in Figure 9.

**Switch and Jumper Settings for 4 mA-to-20 mA Receiver**

For the receiver configuration shown in Figure 4, Switch S1 should be put in the “I-V” position. Jumper P4 should be put in the “0.2-2.3V” position for an output voltage of 0.2 V to 2.3 V, and in the “0.2-4.8V” position for an output voltage of 0.2 V to 4.8 V. See also the photo of the evaluation board in Figure 9.

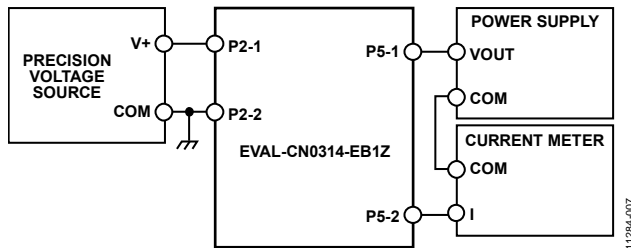

Figure 7. Functional Block Diagram of Test Setup for the Transmitter

For the test setup of the receiver configuration (Figure 9), a second EVAL-CN0314-EB1Z was used to produce a 4 mA-to-20 mA input current. A precision current source can be used if desired. The S1 switch must be placed in the “I-V” position to configure the circuit as a receiver.

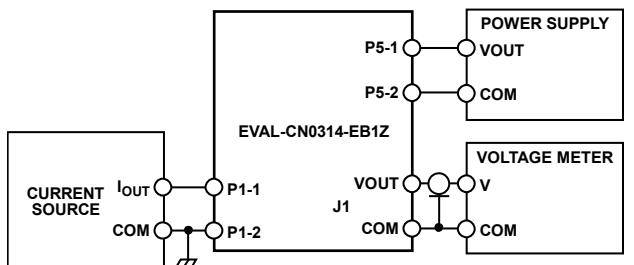

Figure 8. Functional Block Diagram of Test Setup for the Receiver

**LEARN MORE**

CN-0314 Design Support Package:

<http://www.analog.com/CN0314-DesignSupport>

MT-031 Tutorial, *Grounding Data Converters and Solving the Mystery of AGND and DGND*. Analog Devices.

MT-035 Tutorial, *Op Amp Inputs, Outputs, Single-Supply, and Rail-to-Rail Issues*. Analog Devices.

MT-065 Tutorial, *In-Amp Noise*. Analog Devices.

MT-066 Tutorial, *In-Amp Bridge Circuit Error Budget Analysis*. Analog Devices.

MT-087 Tutorial, *Voltage References*. Analog Devices.

MT-101 Tutorial, *Decoupling Techniques*. Analog Devices.

Voltage Reference Wizard Design Tool.

**Data Sheets and Evaluation Boards**

CN-0314 Circuit Evaluation Board (EVAL-CN0314-EB1Z)

AD8420 Data Sheet

ADR02 Data Sheet

**REVISION HISTORY**

3/14—Revision 0: Initial Version

(Continued from first page) Circuits from the Lab reference designs are intended only for use with Analog Devices products and are the intellectual property of Analog Devices or its licensors. While you may use the Circuits from the Lab reference designs in the design of your product, no other license is granted by implication or otherwise under any patents or other intellectual property by application or use of the Circuits from the Lab reference designs. Information furnished by Analog Devices is believed to be accurate and reliable. However, Circuits from the Lab reference designs are supplied "as is" and without warranties of any kind, express, implied, or statutory including, but not limited to, any implied warranty of merchantability, noninfringement or fitness for a particular purpose and no responsibility is assumed by Analog Devices for their use, nor for any infringements of patents or other rights of third parties that may result from their use. Analog Devices reserves the right to change any Circuits from the Lab reference designs at any time without notice but is under no obligation to do so.

©2014 Analog Devices, Inc. All rights reserved. Trademarks and registered trademarks are the property of their respective owners.  
CN11284-0-3/14(0)

