

DUAL FORWARD-CONDUCTING P-GATE THYRISTORS PROGRAMMABLE OVERVOLTAGE PROTECTORS

This model is $\text{Sd } \overline{\text{M}}/\text{R}_\text{Unot}$ recommended for new designs. The Model TISP61521 is functionally similar and pin-to-pin compatible.



BOURNS®

TISP61511D Gated Protectors

Dual Voltage-Programmable Protectors.

- Wide 0 to -80 V Programming Range
- Low 5 mA max. Triggering Current
- High 150 mA min. Holding Current

Rated for International Surge Wave Shapes

Voltage Wave Shape	Standard	I_{TSP} A
2/10 s	TR-NWT-001089	170
1.2/50 s	ETS 300 047-1	90
0.5/700 s	RLM88/I3124	40
10/700 s	K17, K20, K21	40
10/1000 s	TR-NWT-001089	30

Functional Replacements for

Device Type	Package Type	Functional Replacement Order As
LCP1511, LCP1511D, ATTL7591AS, MGSS150-1	8-pin Small-Outline	TISP61511DR-S for Taped and Reeled



..... UL Recognized

Description

The TISP61511D is a dual forward-conducting buffered p-gate over-voltage protector. It is designed to protect monolithic Subscriber Line Interface Circuits, SLICs, against overvoltages on the telephone line caused by lightning, ac power contact and induction. The TISP61511D limits voltages that exceed the SLIC supply rail voltage.

The SLIC line driver section is typically powered from 0 V (ground) and a negative voltage in the region of -10 V to -70 V. The protector gate is connected to this negative supply. This references the protection (clipping) voltage to the negative supply voltage. As the protection voltage will track the negative supply voltage the overvoltage stress on the SLIC is minimized.

Positive overvoltages are clipped to ground by diode forward conduction. Negative overvoltages are initially clipped close to the SLIC negative supply rail value. If sufficient current is available from the overvoltage, then the protector will crowbar into a low voltage on-state condition. As the current subsides the high holding current of the crowbar helps prevent d.c. latchup.

These monolithic protection devices are fabricated in ion-implanted planar vertical power structures for high reliability and in normal system operation they are virtually transparent. The buffered gate design reduces the loading on the SLIC supply during overvoltages caused by power cross and induction.

How To Order

Device	Package	Carrier	Order As
TISP61511	D (8-pin Small-Outline)	Embossed Tape Reeled	TISP61511DR-S

D Package (Top View)

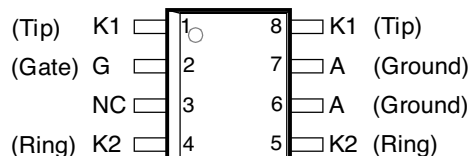

MD6XANB

NC - No internal connection
Terminal typical application names shown in parenthesis

Device Symbol

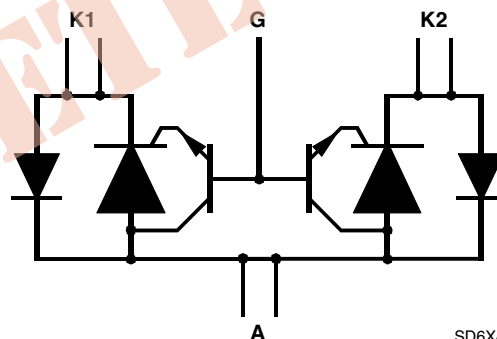

SD6XAE

Terminals K1, K2 and A correspond to the alternative line designators of T, R and G or A, B and C. The negative protection voltage is controlled by the voltage, V_{GG} , applied to the G terminal.

*RoHS Directive 2002/95/EC Jan. 27, 2003 including annex and RoHS Recast 2011/65/EU June 8, 2011.

JULY 1995 — REVISED JANUARY 2016

Specifications are subject to change without notice.

The device characteristics and parameters in this data sheet can and do vary in different applications and actual device performance may vary over time.

Users should verify actual device performance in their specific applications.

TISP61511D Gated Protectors

BOURNS®

Absolute Maximum Ratings

Rating	Symbol	Value	Unit
Repetitive peak off-state voltage, $V_{GK} = 0, -40\text{ °C} \leq T_J \leq 85\text{ °C}$	V_{DRM}	-100	V
Repetitive peak gate-cathode voltage, $V_{KA} = 0, -40\text{ °C} \leq T_J \leq 85\text{ °C}$	V_{GKRM}	-85	V
Non-repetitive peak on-state pulse current (see Notes 1 and 2)	I_{TSP}	30	A
10/1000 μs		40	
5/310 μs		40	
0.2/310 μs		90	
1/20 μs		120	
2/10 μs		170	
		$T_J = -40\text{ °C}$	
		$T_J = 25\text{ °C}, 85\text{ °C}$	
Non-repetitive peak on-state current, 50 Hz (see Notes 1 and 2)	I_{TSM}	5	A
full-sine-wave, 20 ms		3.5	
1 s			
Non-repetitive peak gate current, half-sine-wave, 10 ms (see Notes 1 and 2)	I_{GSM}	2	A
Junction temperature	T_J	-55 to +150	°C
Storage temperature range	T_{stg}	-55 to +150	°C

- NOTES: 1. Initially the protector must be in thermal equilibrium with $-40\text{ °C} \leq T_J \leq 85\text{ °C}$. The surge may be repeated after the device returns to its initial conditions. See the applications section for the details of the impulse generators.
2. The rated current values may be applied either to the Ring to Ground or to the Tip to Ground terminal pairs. Additionally, both terminal pairs may have their rated current values applied simultaneously (in this case the Ground terminal current will be twice the rated current value of an individual terminal pair). Above 85 °C , derate linearly to zero at 150 °C lead temperature.

Recommended Operating Conditions

Component	Min	Typ	Max	Unit
C_G Gate decoupling capacitor		220		nF

Electrical Characteristics, $T_J = 25\text{ °C}$ (Unless Otherwise Noted)

Parameter	Test Conditions	Min	Typ	Max	Unit
I_D Off-state current	$V_D = -85\text{ V}, V_{GK} = 0$			5	μA
				$T_J = 70\text{ °C}$	50
$V_{(BO)}$ Breakover voltage	$I_T = 30\text{ A}, 10/1000\ \mu\text{s}, 1\text{ kV}, R_S = 33\ \Omega, di/dt_{(i)} = 8\text{ A}/\mu\text{s}$ (see Note 3)			-58	V
$V_{GK(BO)}$ Gate-cathode voltage at breakover	$I_T = 30\text{ A}, 10/700\ \mu\text{s}, 1.5\text{ kV}, R_S = 10\ \Omega, di/dt_{(i)} = 14\text{ A}/\mu\text{s}$ (see Note 3)			10	V
	$I_T = 30\text{ A}, 1.2/50\ \mu\text{s}, 1.5\text{ kV}, R_S = 10\ \Omega, di/dt_{(i)} = 70\text{ A}/\mu\text{s}$ (see Note 3)			20	
	$I_T = 38\text{ A}, 2/10\ \mu\text{s}, 2.5\text{ kV}, R_S = 61\ \Omega, di/dt_{(i)} = 40\text{ A}/\mu\text{s}$ (see Note 3)			25	
V_T On-state voltage	$I_T = 0.5\text{ A}, t_w = 500\ \mu\text{s}$			3	V
	$I_T = 3\text{ A}, t_w = 500\ \mu\text{s}$			4	
V_F Forward voltage	$I_F = 5\text{ A}, t_w = 500\ \mu\text{s}$			3	V
V_{FRM} Peak forward recovery voltage	$I_F = 30\text{ A}, 10/1000\ \mu\text{s}, 1\text{ kV}, R_S = 33\ \Omega, di/dt_{(i)} = 8\text{ A}/\mu\text{s}$ (see Note 3)			5	V
	$I_T = 30\text{ A}, 10/700\ \mu\text{s}, 1.5\text{ kV}, R_S = 10\ \Omega, di/dt_{(i)} = 14\text{ A}/\mu\text{s}$ (see Note 3)			5	
	$I_T = 30\text{ A}, 1.2/50\ \mu\text{s}, 1.5\text{ kV}, R_S = 10\ \Omega, di/dt_{(i)} = 70\text{ A}/\mu\text{s}$ (see Note 3)			7	
	$I_T = 38\text{ A}, 2/10\ \mu\text{s}, 2.5\text{ kV}, R_S = 61\ \Omega, di/dt_{(i)} = 40\text{ A}/\mu\text{s}$ (see Note 3)			12	

NOTE 3: All tests have $C_G = 220\text{ nF}$ and $V_{GG} = -48\text{ V}$. R_S is the current limiting resistor between the output of the impulse generator and the R or T terminal. See the applications section for the details of the impulse generators.

JULY 1995 — REVISED JAN 2016

Specifications are subject to change without notice.

Customers should verify actual device performance in their specific applications.

TISP61511D Gated Protectors

BOURNS®

Electrical Characteristics, $T_J = 25^\circ\text{C}$ (Unless Otherwise Noted) (Continued)

Parameter	Test Conditions	Min	Typ	Max	Unit	
I_H Holding current	$I_T = 1\text{ A}$, $di/dt = -1\text{ A/ms}$, $V_{GG} = -48\text{ V}$	150			mA	
I_{GAS} Gate reverse current	$V_{GG} = -75\text{ V}$, K and A terminals connected			$T_J = 25^\circ\text{C}$	5	μA
				$T_J = 70^\circ\text{C}$	50	μA
I_{GT} Gate trigger current	$I_T = 3\text{ A}$, $t_{p(g)} \geq 20\ \mu\text{s}$, $V_{GG} = -48\text{ V}$	0.2		5	mA	
V_{GT} Gate trigger voltage	$I_T = 3\text{ A}$, $t_{p(g)} \geq 20\ \mu\text{s}$, $V_{GG} = -48\text{ V}$			2.5	V	
C_{AK} Anode-cathode off-state capacitance	$f = 1\text{ MHz}$, $V_d = 1\text{ V}$, $I_G = 0$, (see Note 4)			$V_D = -3\text{ V}$	100	pF
				$V_D = -48\text{ V}$	50	pF

NOTE 4: These capacitance measurements employ a three terminal capacitance bridge incorporating a guard circuit. The unmeasured device terminals are a.c. connected to the guard terminal of the bridge.

Thermal Characteristics

Parameter	Test Conditions	Min	Typ	Max	Unit
$R_{\theta JA}$ Junction to free air thermal resistance	$P_{tot} = 0.8\text{ W}$, $T_A = 25^\circ\text{C}$ 5 cm ² , FR4 PCB D Package			170	$^\circ\text{C/W}$

OBSOLETE

Parameter Measurement Information

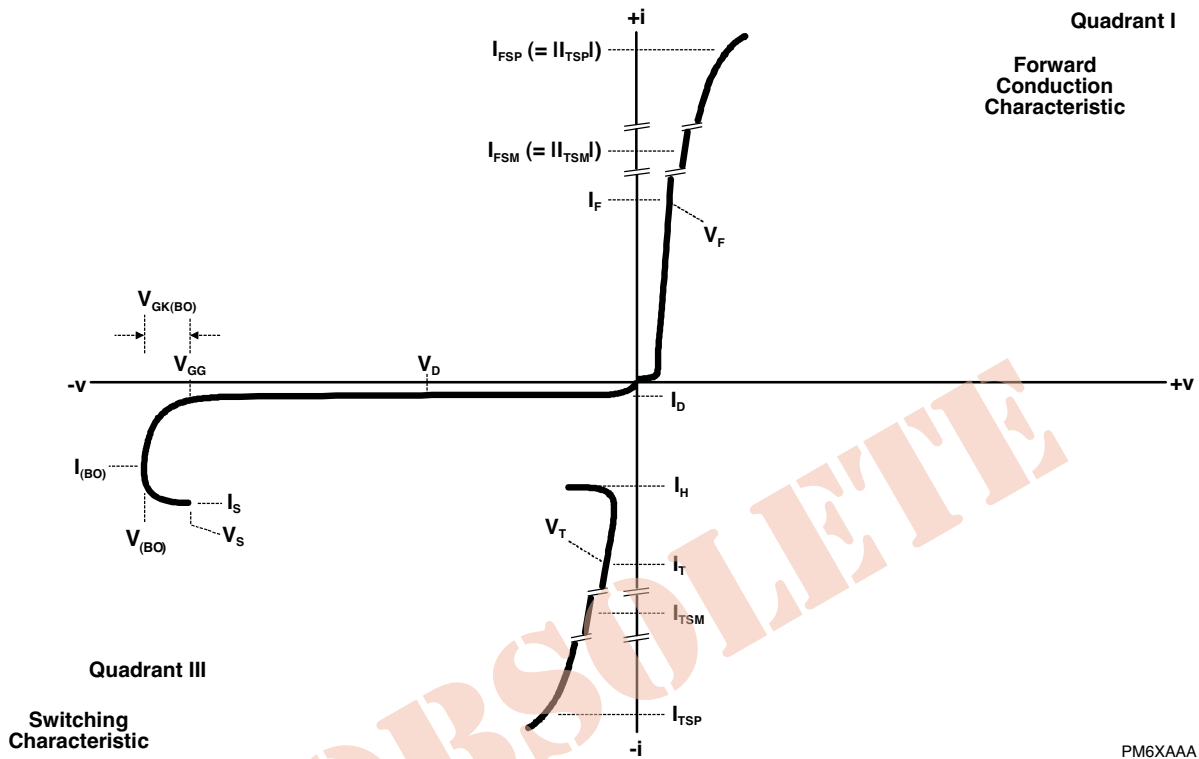

Figure 1. Voltage-Current Characteristic

PM6XAAA

Thermal Information

MAXIMUM NON-RECURRING 50 Hz CURRENT
vs
CURRENT DURATION

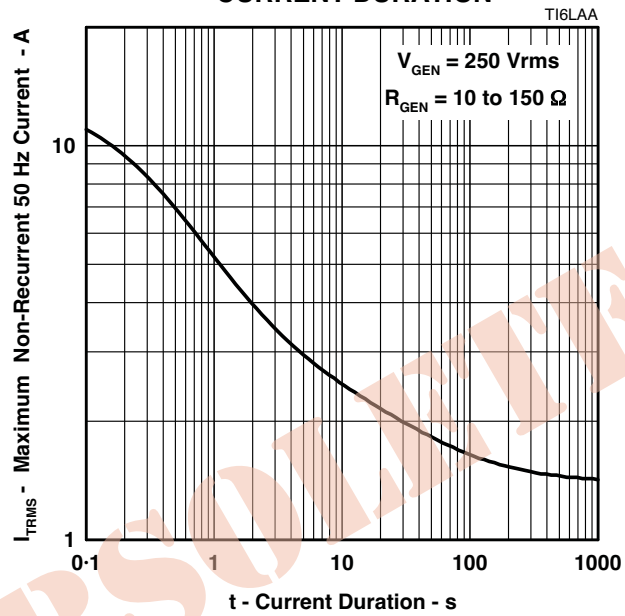

Figure 2.

DEVICE PARAMETERS

General

Thyristor based overvoltage protectors, for telecommunications equipment, became popular in the late 1970s. These were fixed voltage breakover triggered devices, likened to solid state gas discharge tubes. As these were new forms of thyristors, the existing thyristor terminology did not cover their special characteristics. This resulted in the invention of new terms based on the application usage and device characteristic. Initially, there was a wide diversity of terms to describe the same thing, but today the number of terms have reduced and stabilized.

Programmable, (gated), overvoltage protectors are relatively new and require additional parameters to specify their operation. Similarly to the fixed voltage protectors, the introduction of these devices has resulted in a wide diversity of terms to describe the same thing. To help promote an understanding of the terms and their alternatives, this section has a list of alternative terms and the parameter definitions used for this data sheet. In general, the Bourns approach is to use terms related to the device internal structure, rather than its application usage as a single device may have many applications each using a different terminology for circuit connection.

Alternative Symbol Cross-Reference Guide

This guide is intended to help the translation of alternative symbols to those used in this data sheet. As in some cases the alternative symbols have no substance in international standards and are not fully defined by the originators, users must confirm symbol equivalence. No liability will be assumed from the use of this guide.

Parameter	Data Sheet Symbol	Alternative Symbol	Alternative Parameter
Non-repetitive peak on-state pulse current	I_{TSP}	I_{PP}	Peak pulse current
Off-state current	I_D	I_R I_{RM}	Reverse leakage current LINE/GND
Gate reverse current (with A and K terminals connected)	I_{GAS}	I_{RG}	Reverse leakage current GATE/LINE
Off-state voltage	V_D	V_R V_{RM}	Reverse voltage LINE/GND
Peak forward recovery voltage	V_{FRM}	V_{FP}	Peak forward voltage LINE/GND
Breakover voltage	$V_{(BO)}$	V_{SGL}	Dynamic switching voltage GND/LINE
Gate voltage, (V_{GG} is gate supply voltage referenced to the A terminal)	V_G	V_{gate} V_{GATE} V_S	GATE/GND voltage
Repetitive peak off-state voltage	V_{DRM}	V_{MLG}	Maximum voltage LINE/GND
Repetitive peak gate-cathode voltage	V_{GKM}	V_{MGL}	Maximum voltage GATE/LINE
Gate-cathode voltage	V_{GK}	V_{GL}	GATE/LINE voltage
Gate-cathode voltage at breakover	$V_{GK(BO)}$	V_{DGL}	Dynamic switching voltage GATE/LINE
Cathode-anode voltage	V_K	V_{LG} $V_{GND/LINE}$	LINE/GND voltage
Anode-cathode capacitance	C_{AK}	C_{off}	Off-state capacitance LINE/GND
Cathode 1 terminal	K1	Tip	Tip terminal
Cathode 2 terminal	K2	Ring	Ring terminal
Anode terminal	A	GND	Ground terminal
Gate terminal	G	Gate	Gate terminal
Thermal Resistance, junction to ambient	$R_{\theta JA}$	$R_{th} (j-a)$	Thermal Resistance, junction to ambient

APPLICATIONS INFORMATION

Electrical Characteristics

The electrical characteristics of a thyristor overvoltage protector are strongly dependent on junction temperature, T_J . Hence a characteristic value will depend on the junction temperature at the instant of measurement. The values given in this data sheet were measured on commercial testers, which generally minimize the temperature rise caused by testing.

Application Circuit

Figure 3 shows a typical TISP61511D SLIC card protection circuit. The incoming line wires, R and T, connect to the relay matrix via the series overcurrent protection. Fusible resistors, fuses and positive temperature coefficient (PTC) resistors can be used for overcurrent protection. Resistors will reduce the prospective current from the surge generator for both the TISP61511D and the ring/test protector. The TISP7xxxF3 protector has the same protection voltage for any terminal pair. This protector is used when the ring generator configuration may be ground or battery-backed. For dedicated ground-backed ringing generators, the TISP3xxxF3 gives better protection as its inter-wire protection voltage is twice the wire to ground value.

Relay contacts 3a and 3b connect the line wires to the SLIC via the TISP61511D protector. The protector gate reference voltage comes from the SLIC negative supply (V_{BAT}). A 220 nF gate capacitor sources the high gate current pulses caused by fast rising impulses.

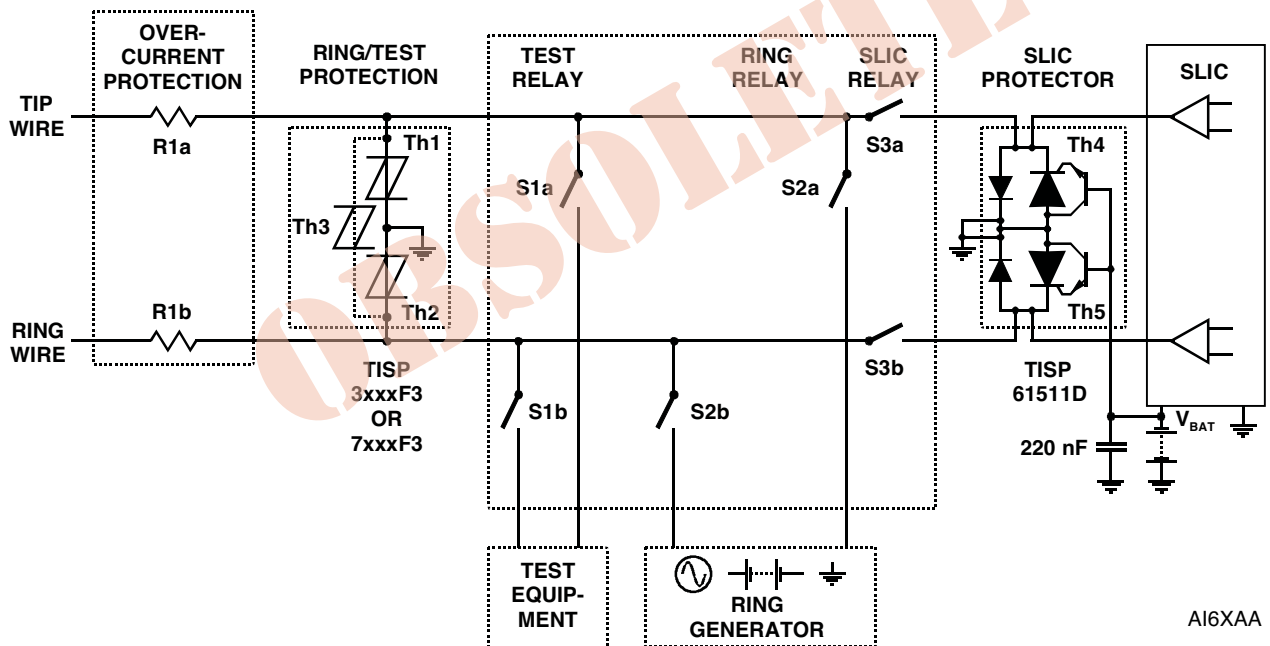

Figure 3. Typical Application Circuit

Impulse Conditions

Most lightning tests, used for equipment verification, specify a unidirectional sawtooth waveform which has an exponential rise and an exponential decay. Wave shapes are classified in terms of Peak Amplitude (voltage or current), rise time and a decay time to 50 % of the maximum amplitude. The notation used for the wave shape is *amplitude, rise time/decay time*. A 38 A, 5/310 μ s wave shape would have a peak current value of 38 A, a rise time of 5 μ s and a decay time of 310 μ s.

There are three categories of surge generator type; single wave shape, combination wave shape and circuit defined. Single wave shape generators have essentially the same waveshape for the open circuit voltage and short circuit current (e.g. 10/1000 μ s open circuit voltage and short circuit current). Combination generators have two wave shapes, one for the open circuit voltage and the other for the short circuit current (e.g. 1.2/50 μ s open circuit voltage and 8/20 μ s short circuit current). Circuit specified generators usually equate to a combination generator, although typically only the open circuit voltage waveshape is referenced (e.g. a 10/700 μ s open circuit voltage generator typically produces a 5/310 μ s short circuit current). If the combination or circuit defined generators operate into a finite resistance the wave shape produced is intermediate between the open circuit and short circuit values.

JULY 1995 — REVISED JAN 2016

Specifications are subject to change without notice.

Customers should verify actual device performance in their specific applications.

Impulse Conditions (Continued)

When the TISP switches into the on-state it has a very low impedance. As a result, although the surge wave shape may be defined in terms of open circuit voltage, it is the current wavelshape that must be used to assess the TISP surge requirement. As an example, the CCITT IX K17 1.5 kV, 10/700 μ s surge is changed to a 38 A 5/310 μ s wavelshape when driving into a short circuit. The impulse generators used for rated values are tabulated below

Impulse Generators used for Rated Values

Standard	Peak Voltage	Voltage	Generator Fictive	External	Peak Current	Current
	Setting	Wave Form		Series Resistance		
	V	μ s	Y	Y	A	μ s
TR-NWF-001089	2500	2/10	5	10	170	2/10
ETS 300 047-1	3000	1.2/50	38	0	80	0.6/18
RLM88/13124	1600	0.5/700	40	0	40	0.2/310
K17, K20, K21	1600	10/700	40	0	40	5/310
TR-NWF-001089	1000	10/1000	10	23	30	10/1000

Figures 4. and 5. show how the TISP61511D limits negative and positive overvoltages. Negative overvoltages (Figure 4.) are initially clipped close to the SLIC negative supply rail value (V_{BAT}). If sufficient current is available from the overvoltage, then the protector (Th5) will crowbar into a low voltage on-state condition. As the overvoltage subsides the high holding current of the crowbar prevents dc latchup. The protection voltage will be the sum of the gate supply (V_{BAT}) and the peak gate-cathode voltage ($V_{GK(BO)}$). The protection voltage will be increased if there is a long connection between the gate decoupling capacitor, C, and the gate terminal. During the initial rise of a fast impulse, the gate current (I_G) is the same as the cathode current (I_K). Rates of 70 A/ μ s can cause inductive voltages of 0.7 V in 2.5 cm of printed wiring track. To minimize this inductive voltage increase of protection voltage, the length of the capacitor to gate terminal tracking should be minimized. Inductive voltages in the protector cathode wiring can increase the protection voltage. These voltages can be minimized by routing the SLIC connection through the protector as shown in Figure 3.

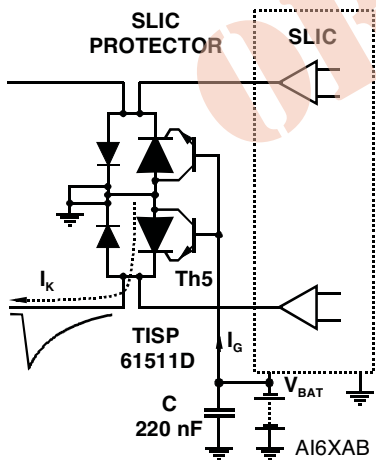

Figure 4. Negative Overvoltage Condition

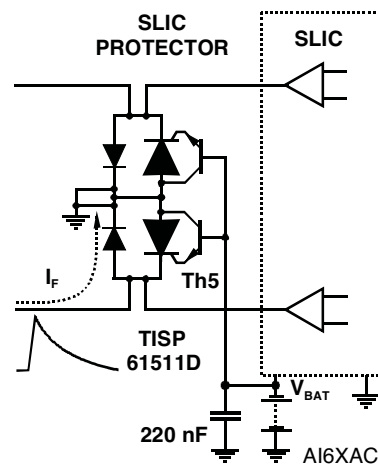

Figure 5. Positive Overvoltage Condition

Positive overvoltages (Figure 5.) are clipped to ground by forward conduction of the diode section in protector (Th5). Fast rising impulses will cause short term overshoots in forward voltage (V_{FRM}).

The thyristor protection voltage, (V_{BO}) increases under lightning surge conditions due to thyristor regeneration time. This increase is dependent on the rate of current rise, di/dt , when the TISP is clamping the voltage in its breakdown region. The diode protection voltage, known as the forward recovery voltage, (V_{FRM}) is dependent on the rate of current rise, di/dt . An estimate of the circuit di/dt can be made from the surge generator voltage rate of rise, dv/dt , and the circuit resistance. The impulse generators used for characterizing the protection voltages are tabulated on the next page.

TISP61511D Gated Protectors

BOURNS®

Impulse Generators used for Electrical Characteristic Values

Standard	Peak Voltage Setting V	Voltage Wave Form μs	Generator Fictive Source Impedance Y	External Series Resistance Y	Peak Current A	$di/dt_{(i)}$ Initial Rate Of Rise A/ μs	Current Wave Form μs
TR-NWT-001089	2500	2/10	5	61	38	40	2/10
ETS 300 047-1	1500	1.2/50	38	12	30	70	0.6/21
K17, K20, K21	1500	10/700	40	10	30	14	5/350
TR-NWT-001089	1000	10/1000	10	23	30	8	10/1000

OBSOLETE

"TISP" is a trademark of Bourns, Ltd., a Bourns Company, and is Registered in U.S. Patent and Trademark Office.
"Bourns" is a registered trademark of Bourns, Inc. in the U.S. and other countries.

JULY 1995 — REVISED JAN 2016

Specifications are subject to change without notice.

Customers should verify actual device performance in their specific applications.