

### FEATURES

- No opto feedback
- Patents protected
- Optimised bipolar output voltages for IGBT/ SiC & Mosfet gate drives
- Configurable dual outputs for all gate drive applications: +15V/-5V, +15V/-10V & +20V/-5V outputs
- Reinforced insulation to UL60950 recognised
- ANSI/AAMI ES60601-1 1MOPP/2MOOPs recognised
- Characterised CMTI >100kV/μS
- Characterised partial discharge performance
- 5.2kVDC isolation test voltage 'Hi Pot Test'
- Ultra low isolation capacitance 15pF
- Continuous barrier withstand voltage 3kVDC
- 5V, 12V & 24V input voltages
- 105°C operating temperature

### PRODUCT OVERVIEW

Offering configurable dual output voltages of +15V/-10V, +20V/-5V and +15V/-5V, the MGJ3 series of DC-DC converters is ideal for powering 'high side' and 'low side' gate drive circuits for IGBTs, Silicon and Silicon Carbide Mosfets in bridge circuits. A choice of asymmetric output voltages allows optimum drive levels for best system efficiency and EMI. The MGJ3 series is characterised for high isolation and dv/dt requirements commonly seen in bridge circuits used in motor drives and inverters. A disable/frequency synchronisation pin simplifies EMC filter design. The MGJ3 protection features include short circuit protection and overload protection.



### SELECTION GUIDE

Order Code <sup>1</sup>	Input Voltage Range	Typical Application	Output 1			Output 2		
			Rated Output Voltage	Rated Output Current	Output Power	Rated Output Voltage	Rated Output Current	Output Power
			V	mA	W	V	mA	W
MGJ3T05150505MC	4.5 - 9	IGBT	+15	120	1.8	-10	120	1.2
MGJ3T12150505MC	9 - 18	IGBT	+15	120	1.8	-10	120	1.2
MGJ3T24150505MC	18 - 36	IGBT	+15	120	1.8	-10	120	1.2
MGJ3T05150505MC	4.5 - 9	SiC	+20	120	2.4	-5	120	0.6
MGJ3T12150505MC	9 - 18	SiC	+20	120	2.4	-5	120	0.6
MGJ3T24150505MC	18 - 36	SiC	+20	120	2.4	-5	120	0.6
MGJ3T05150505MC	4.5 - 9	MOSFET	+15	150	2.25	-5	150	0.75
MGJ3T12150505MC	9 - 18	MOSFET	+15	150	2.25	-5	150	0.75
MGJ3T24150505MC	18 - 36	MOSFET	+15	150	2.25	-5	150	0.75

### SELECTION GUIDE (Continued)

Order Code <sup>1</sup>	Input Voltage Range	Typical Application	Output 1				Output 2			
			Load Regulation (Typ) <sup>3</sup>	Load Regulation (Max) <sup>3</sup>	Ripple & Noise (Typ) <sup>2</sup>	Ripple & Noise (Max) <sup>2</sup>	Load Regulation (Typ) <sup>3</sup>	Load Regulation (Max) <sup>3</sup>	Ripple & Noise (Typ) <sup>2</sup>	Ripple & Noise (Max) <sup>2</sup>
			%	%	mVp-p	mVp-p	%	%	mVp-p	mVp-p
MGJ3T05150505MC	4.5 - 9	IGBT	3	10	69	200	3	10	98	150
MGJ3T12150505MC	9 - 18	IGBT	3	10	85	200	3	10	108	150
MGJ3T24150505MC	18 - 36	IGBT	3	10	83	200	3	10	104	150
MGJ3T05150505MC	4.5 - 9	SiC	3	10	118	275	3	10	49	75
MGJ3T12150505MC	9 - 18	SiC	3	10	139	275	3	10	54	75
MGJ3T24150505MC	18 - 36	SiC	3	10	135	275	3	10	52	75
MGJ3T05150505MC	4.5 - 9	MOSFET	3	10	69	200	3	10	49	75
MGJ3T12150505MC	9 - 18	MOSFET	3	10	85	200	3	10	54	75
MGJ3T24150505MC	18 - 36	MOSFET	3	10	83	200	3	10	52	75

1. Components are supplied in tape and reel packaging, please refer to package specification section. Orderable part numbers are MGJ3TXX150505MC-R7 (23 pieces per reel), or MGJ3TXX150505MC-R13 (92 pieces per reel).

2. See ripple & noise test method.

3. Between 50% and 100% rated output current.

All specifications typical at T<sub>a</sub>=25°C, nominal input voltage and rated output current unless otherwise specified.

SELECTION GUIDE (Continued)							
Order Code	Nominal Input Voltage	Input Current at Rated Load	Efficiency (Min)	Efficiency (Typ)	Isolation Capacitance	MTTF <sup>1</sup>	
						MIL 217	Telecordia
	V	mA	%	pF	kHrs		
MGJ3T05150505MC	5	760	75	78.5	15	889	6662
MGJ3T12150505MC	12	310	78	82	15	939	6596
MGJ3T24150505MC	24	155	77	81	15	915	6596

INPUT CHARACTERISTICS						
Parameter	Conditions	Min.	Typ.	Max.	Units	
Voltage range	5V input types	4.5	5	9	V	
	12V input types	9	12	18		
	24V input types	18	24	36		
Under voltage lock out	Turn on threshold MGJ3T05		4.1		V	
	Turn off threshold MGJ3T05		3.0			
	Turn on threshold MGJ3T12		8.1			
	Turn off threshold MGJ3T12		7.5			
	Turn on threshold MGJ3T24		16.7			
	Turn off threshold MGJ3T24		16.1			
Input ripple current	5V input types		18		mA p-p	
	12V input types		12			
	24V input types		9			

OUTPUT CHARACTERISTICS						
Parameter	Conditions	Min.	Typ.	Max.	Units	
Minimum load	Below 10% load, 5V and 15V outputs are clamped to 6V and 16V respectively	10			%	
Voltage set point accuracy	Nominal output voltages are at 75% loading		±4		%	
Line regulation	Low line to high line			2	%	
Transient response	Peak deviation (50-100% & 100-50% load swing)		1.2		%V <sub>out</sub>	
	Settling time		0.25		ms	

ISOLATION CHARACTERISTICS						
Parameter	Conditions	Min.	Typ.	Max.	Units	
Isolation test voltage	Flash tested for 1 second	5200			VDC	
	Qualification tested for 1 minute	5200				
Resistance	Viso = 1kVDC	100			GΩ	
Continuous barrier withstand voltage	Non-safety barrier application			3000	V	
Safety standard	UL60950-1	Reinforced	Creepage and clearance 7mm		250	Vrms
	ANSI/AAMI ES60601-1	1 MOPP/2 MOOP			250	

GENERAL CHARACTERISTICS						
Parameter	Conditions	Min.	Typ.	Max.	Units	
Switching frequency			100		kHz	

TEMPERATURE CHARACTERISTICS						
Parameter	Conditions	Min.	Typ.	Max.	Units	
Operation	See derating graphs	-40		105	°C	
Storage		-50		125		
Product temperature rise above ambient	100% Load, Nom V <sub>in</sub> , Still Air		18			

ABSOLUTE MAXIMUM RATINGS						
Parameter	Conditions	Min.	Typ.	Max.	Units	
Short-circuit protection		Continuous				
Input voltage, MGJ3 5V input types		12V				
Input voltage, MGJ3 12V input types		20V				
Input voltage, MGJ3 24V input types		40V				

1. Calculated using MIL-HDBK-217 FN2 and Telecordia SR-332 calculation model with nominal input voltage at full load.

**TECHNICAL NOTES**

**ISOLATION VOLTAGE**

'Hi Pot Test', 'Flash Tested', 'Withstand Voltage', 'Proof Voltage', 'Dielectric Withstand Voltage' & 'Isolation Test Voltage' are all terms that relate to the same thing, a test voltage, applied for a specified time, across a component designed to provide electrical isolation, to verify the integrity of that isolation.

Murata Power Solutions MGJ3 series of DC-DC converters are all 100% production tested at 5.2kVDC for 1 second and qualification tested at 5.2kVDC for 1 minute.

The MGJ3 series is recognised by Underwriters Laboratory, please see safety approval section for more information. When the insulation in the MGJ3 series is not used as a safety barrier, i.e. provides functional isolation only, continuous or switched voltages across the barrier up to 3kV are sustainable. This is established by measuring the partial discharge inception voltage in accordance with IEC 60270. Please contact Murata for further information.

**REPEATED HIGH-VOLTAGE ISOLATION TESTING**

It is well known that repeated high-voltage isolation testing of a barrier component can actually degrade isolation capability, to a lesser or greater degree depending on materials, construction and environment. We therefore strongly advise against repeated high voltage isolation testing, but if it is absolutely required, that the voltage be reduced by 20% from specified test voltage.

**SAFETY APPROVAL**

**ANSI/AAMI ES60601-1**

The MGJ3 series is recognised to ANSI/AAMI ES60601-1 and provides 1 MOPP (Means Of Patient Protection) and 2 MOOP (Means Of Operator Protection) based upon a working voltage of 250 Vrms max, between Primary and Secondary.

**UL 60950**

The MGJ3 series has been recognised by Underwriters Laboratory (UL) to UL 60950 for reinforced insulation to a working voltage of 250Vrms with a maximum measured product operating temperature of 105°C.

Creepage and clearance 7mm.

**FUSING**

The MGJ3 Series of converters are not internally fused so to meet the requirements of UL an anti-surge input line fuse should always be used with ratings as defined below.

Input Voltage, 5V 2A

Input Voltage, 12V 1A

Input Voltage, 24V 0.5A

All fuses should be UL recognised, 125V rated.

**RoHS COMPLIANCE, MSL, PSL AND REFLOW SOLDERING INFORMATION**



This series is compatible with RoHS soldering systems with a peak reflow solder temperature of 245°C and Time Above Liquidus for 90 seconds, as per J-STD-020. Please refer to [application notes](#) for further information. The pin termination finish on this product series is Gold with Nickel Pre-plate. The series is backward compatible with Sn/Pb soldering systems. The series has a Moisture Sensitivity Level (MSL) 2. Samples of the product series were tested in accordance with the conditioning described for MSL level 2 in IPC/J-STD-020. The product series passed electrical tests, co-planarity and visual inspection criteria.

### ENVIRONMENTAL VALIDATION TESTING

The following tests have been conducted on this product series, please contact Murata if further information about the tests is required.

Test	Standard	Condition
Temperature cycling	MIL-STD-883 Method 1010, Condition B	10 cycles between two chambers set to achieve -55°C and +125°C. The dwell time shall not be less than 10min and the load shall reach the specified temperature in 15min.
HAST (Unbiased)	JEDEC JESD22-A118	96Hrs +2/-0Hrs at 130°C ± 2°C, 85% ± 5% R.H.
High Temperature Storage life	JEDEC JESD22-A103 Condition A	125°C +10/-0°C for ≥1000 hours.
Vibration	BS EN 61373 with respect to BS EN60068-2-64, Test Fh Category 1 Class B	5 – 150Hz. Level at each axis – Vertical, Traverse and Longitudinal: 5.72m/s <sup>2</sup> rms. 5 hours in each axis. Crest factor: 3 Sigma. Device is secured via surface mount pins.
Shock	BS EN 61373, Category 1 class B	Test is 30ms duration, 3 shocks in each sense of 3 mutually perpendicular axis (18 shocks total). Level at each axis: Vertical, Traverse and Longitudinal: 50m/s <sup>2</sup> . Device is secured via surface mount pins.
Solderability	EIA/IPC/JEDEC J-STD-002, Test S and S1	The parts are conditioned in a steam ager for 8 hours ±15 min. at a temperature of 93±3°C. SnPb (Test S): The parts are placed onto a stencil with Sn60Pb40 solder paste on and then placed into the reflow oven at 215 ±5°C for 50–70 seconds. Pb-free (Test S1): The parts are placed onto a stencil with Sn96.5Ag3.0Cu0.5 solder paste on and then placed into the reflow oven at 245±5°C for 30–60 seconds.
Solvent cleaning	Resistance to cleaning agents	Solvent – Novec 71IPA & Topklean EL-20A. Pulsed ultrasonic immersion 45°C - 65°C.
Solvent Resistance	MIL-STD-883 Method 2015	The parts and the bristle portion of the brush are immersed in Isopropanol for a minimum of 1 minute. The parts are brushed 3 times, after the third time the parts are blown dry and inspected.
Moisture sensitivity level (MSL 2)	Based on IPC/JEDEC J-STD-020	Bake samples at 125 +5/-0°C for 24hours minimum before conditioning in the temperature/humidity chamber for 168 hours at 85°C/60%RH and Pb Free JEDEC Max profile conditioning with electrical testing, co-planarity inspection before and after.

### PART NUMBER STRUCTURE

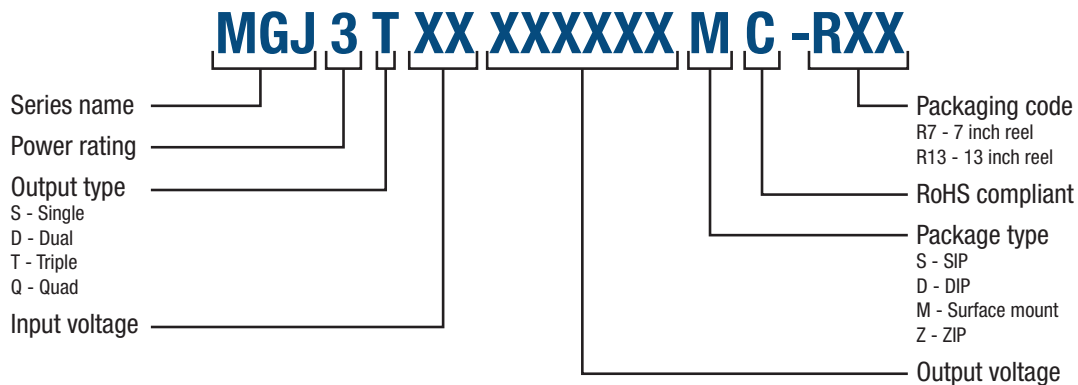

**CHARACTERISATION TEST METHODS**

Ripple & Noise Characterisation Method

Ripple and noise measurements are performed with the following test configuration.

C1	1µF X7R multilayer ceramic capacitor, voltage rating to be a minimum of 3 times the output voltage of the DC-DC converter
C2	10µF tantalum capacitor, voltage rating to be a minimum of 1.5 times the output voltage of the DC-DC converter with an ESR of less than 100mΩ at 100 kHz
C3	100nF multilayer ceramic capacitor, general purpose
R1	450Ω resistor, carbon film, ±1% tolerance
R2	50Ω BNC termination
T1	3T of the coax cable through a ferrite toroid
RLOAD	Resistive load to the maximum power rating of the DC-DC converter. Connections should be made via twisted wires

Measured values are multiplied by 10 to obtain the specified values.

Differential Mode Noise Test Schematic

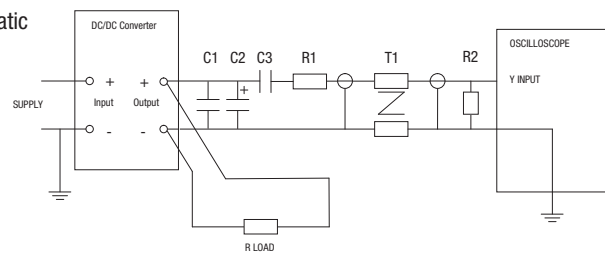

**APPLICATION NOTES**

**Disable/Frequency synchronisation**

Please refer to application notes for further information.

		Min	Typ	Max	Units
Disable/Sync <sup>1</sup>	Pull Down Current		0.5		mA
	Input High	2		60	V
	Input Low	-0.6		0.8	V
Synchronisation	Frequency Range	90	100	110	kHz
	Duty Cycle	25		75	%

The  $\overline{\text{Dis}}/\text{Sync}$  pin has three modes:

1. When a DC logic low voltage is applied to this pin the MGJ3 is disabled and enters a low quiescent current sleep mode.
2. When this pin is left floating or a DC logic high (CMOS/TTL compatible) voltage is applied the MGJ3 is enabled and operates at the programmed frequency of 100kHz.
3. When a square wave of between 90kHz and 110kHz is applied to this pin, the switcher operates at the same frequency as the square wave. The falling edge of the square wave corresponds to the start of the switching cycle. If the signal is slower than 25Hz, it will be interpreted as enabling and disabling the part. If the MGJ3 is disabled, it must be disabled for 7 clock cycles before being re-enabled.

Note: The  $\overline{\text{Dis}}/\text{Sync}$  pin is a high impedance TTL input and can be triggered by noise from external circuits if not treated carefully.

Please refer to "LAYOUT CONSIDERATIONS" and "SYNCHRONISATION CIRCUIT" for further details.

[Click here for general guidance for gate drive applications.](#)

**LAYOUT CONSIDERATIONS**

Unlike standard isolated DC-DC products the MGJ3 series has been designed specifically for high side gate drive applications where the outputs are being driven to a high voltage at a very high dV/dT. This is possible due to minimum transformer isolation capacitance and considered circuit design regarding common mode transient immunity. It is important that these few simple pcb layout guidelines are implemented so as not to compromise the performance of the DC-DC and that of the overall system.

1. The keep clear area shown must not have any copper traces even on internal layers. This is not only to avoid compromising the creepage and clearance distance but also to minimise capacitive isolation between the noisy output circuits and input control circuits. In general it is good practice to maintain the same band of clearance area running directly through both the DC-DC and the gate drive isolators as shown so that input and output are kept separate and do not overlap or mesh together at any point.
2. A top layer ground plane copper area connected to  $-V_{in}$  can be used to create an effective screen to the underside of the MGJ3 series and can also be used as a guard ring for the gate drive isolator inputs. If the  $\overline{\text{Dis}}/\text{Sync}$  pin is being used then it is imperative that it follows a route covered by this screen to avoid differential pick up. It should also be kept as short as possible.

Please refer to "PACKAGE SPECIFICATIONS" for recommended layout.

**SYNCHRONISATION CIRCUIT**

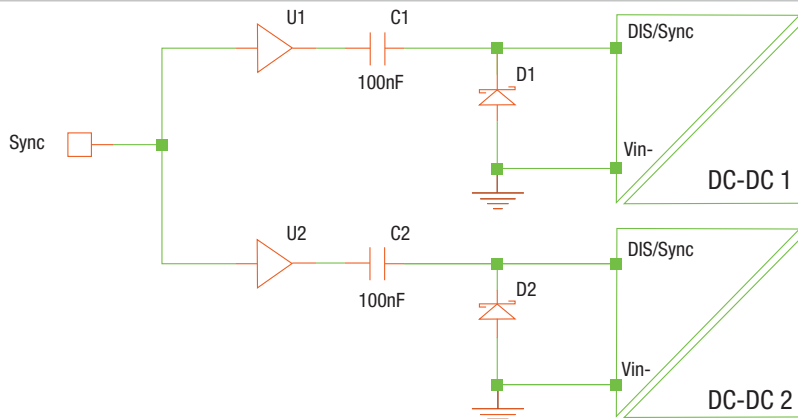

1. A suggested synchronisation circuit is shown. C1 and C2 are 100nF capacitors. D1 and D2 are schottky diodes. The capacitive isolation and close connected diode ensures that a transition from high to low is seen at the input pin even in a noisy environment or when there is a slight ground shift between devices.
2. If the  $\overline{\text{Dis}}/\text{Sync}$  pin is not used for synchronisation, then a 22nF capacitor can be added between the  $\overline{\text{Dis}}/\text{Sync}$  pin and  $-V_{in}$  pin to improve noise immunity. If the functionality of  $\overline{\text{Dis}}/\text{Sync}$  is not required, the  $\overline{\text{Dis}}/\text{Sync}$  pin can be connected directly to the  $+V_{in}$  pin to improve noise immunity.
3. One very effective method to reduce common mode transient interference is to add a common mode filter to the DC input. It may only be necessary to add one before splitting the supply to each DC-DC.

**APPLICATION NOTES (Continued)**

**Start-up times**

Typical start up times for this series, with no additional output capacitance are:

Output capacitance must not exceed:

Part No.	Start-up times
	ms
<b>MGJ3T05150505MC</b>	15
<b>MGJ3T12150505MC</b>	15
<b>MGJ3T24150505MC</b>	15

Output Voltage	Maximum output capacitance
V	µF
15	120
5	220

**Output configurations for power switches**

Terminal	IGBT	SIC	MOSFET
(P10) 15V Output	+15V 0.12A	+20V 0.12A	+15V 0.15A
(P9) 15V Return 5VA Output	0V	No connection	0V
(P7) 5VA Return 5VB Output	No connection	0V	-5V 0.15A
(P8) 5VB Return	-10V 0.12A	-5V 0.12A	No connection

**APPLICATION NOTES (Continued)**

Schematic for driving IGBT, SiC & MOSFET

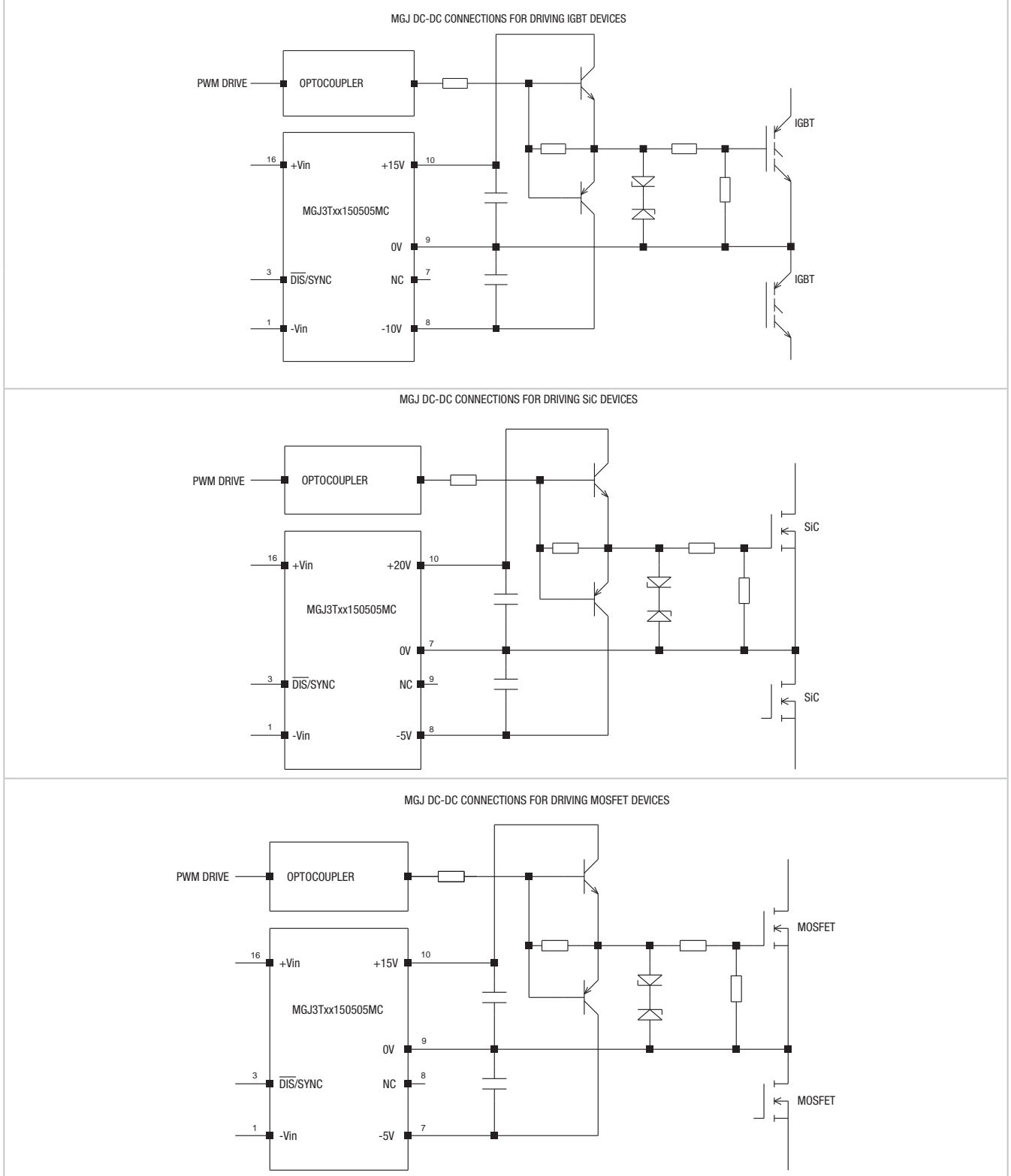



## EFFICIENCY VS LOAD

**MGJ3T05150505MC**

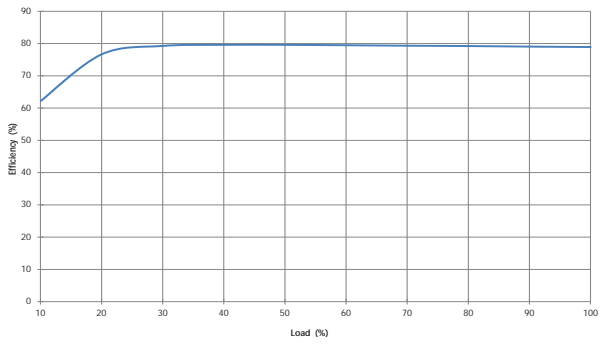

**MGJ3T12150505MC**

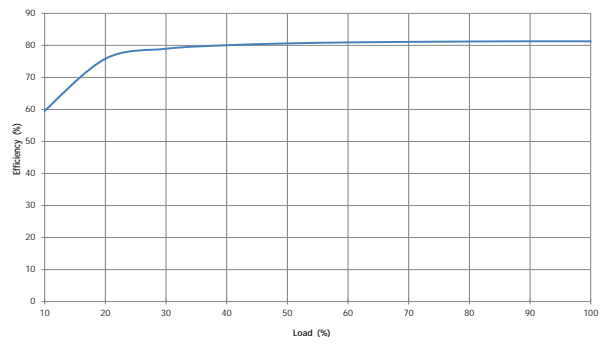

**MGJ3T24150505MC**

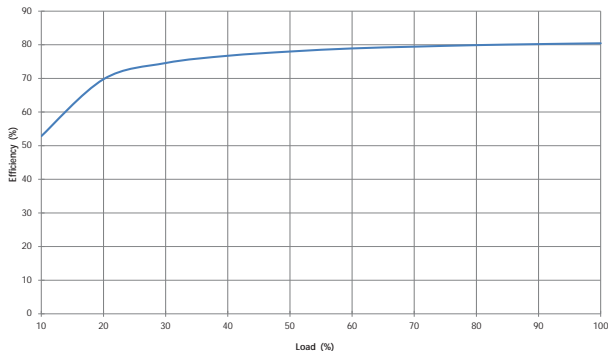

**DERATING GRAPHS**

Derating curves are based on IPC-9592. With no derating some components may be operating at the manufacturers maximum temperature ratings.

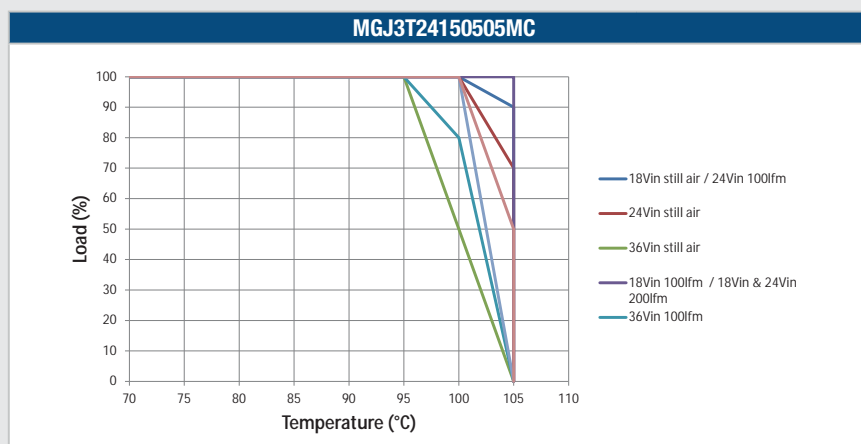
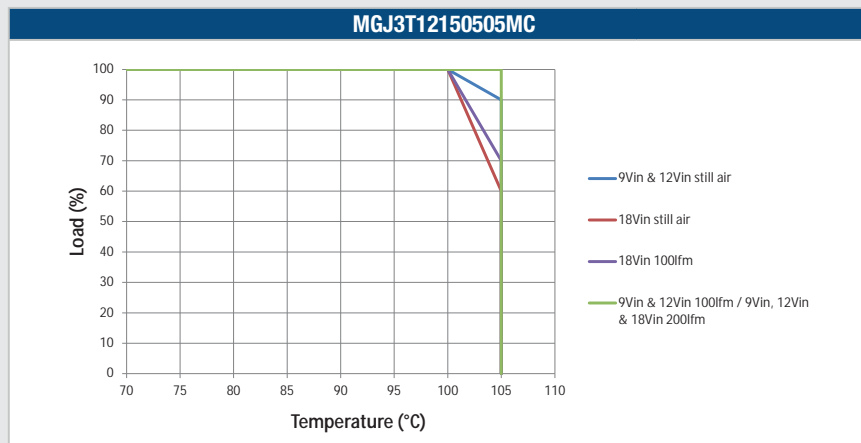
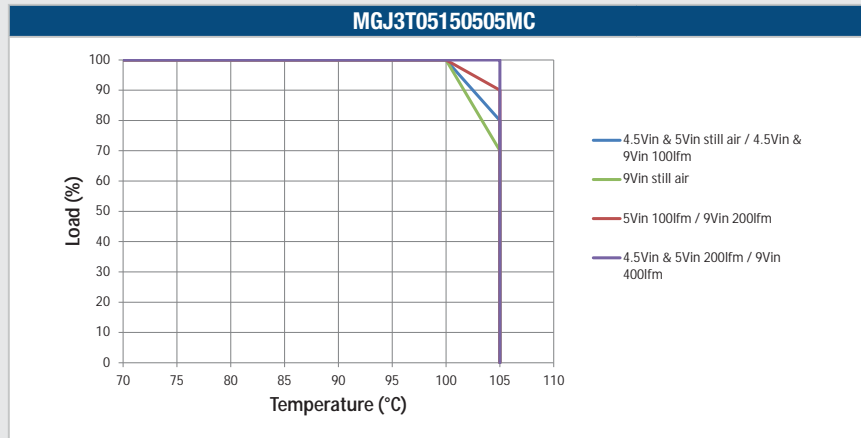

**EMC FILTERING AND SPECTRA**

**FILTERING**

The following filter circuit and filter table shows the input filters typically required to meet EN55022 Quasi-Peak Curve A or B. If a high dv/dt above 80kV/us is expected from output to input it is advised that a common mode filter is used on the input without Y capacitors. This will reduce the common mode current and reduce interference with primary side circuits.

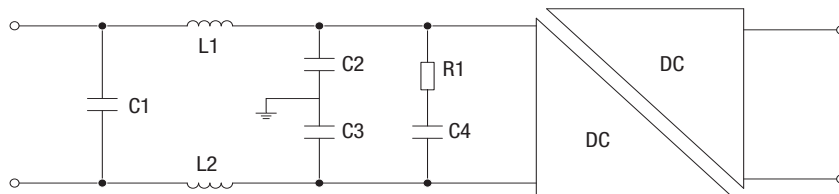

**TO MEET CURVE B**

Part Number	C1	L1	L2	C2	C3	R1	C4
MGJ3T05150505MC	1.5μF	476R8SC		10nF	10nF	500mΩ	220μF
MGJ3T12150505MC	1.5μF	476R8SC		10nF	10nF	500mΩ	220μF
MGJ3T24150505MC	1.5μF	476R8SC		10nF	10nF	500mΩ	220μF

**C1, C2 & C3** Polyester or ceramic capacitor

**C4** Electrolytic capacitor (note R1 could be omitted if C4 has ESR >= R1)

**MGJ3T05150505MC**

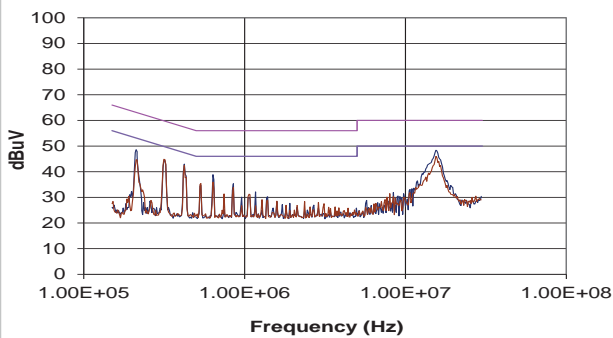

**MGJ3T12150505MC**

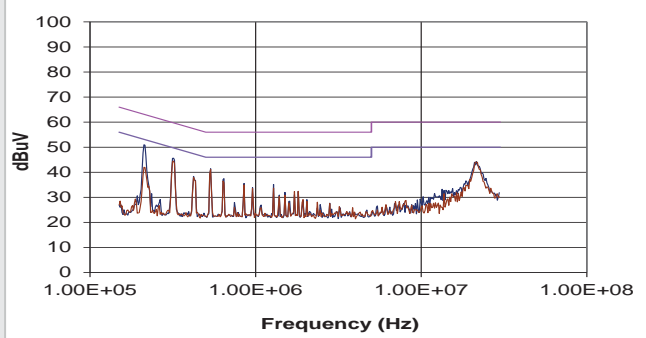

**MGJ3T24150505MC**

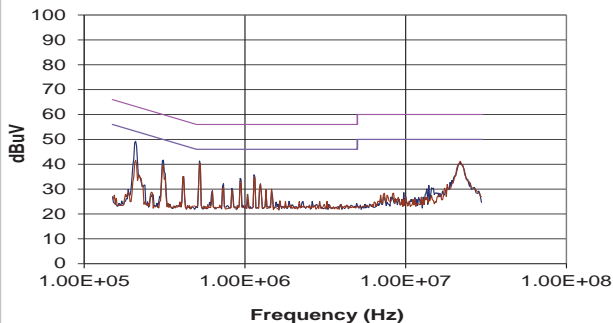

**PACKAGE SPECIFICATIONS**

**MECHANICAL DIMENSIONS**

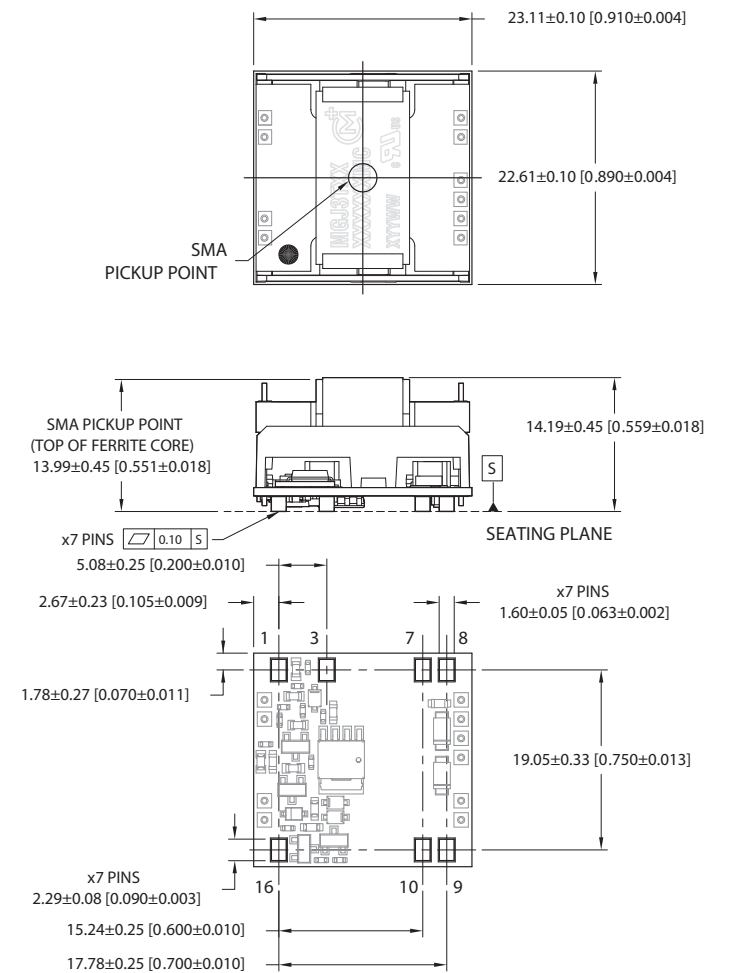

All dimensions in mm (inches). Controlling dimensions in mm.  
Components shown for reference only

Weight: 10.70g

**PIN CONNECTIONS**

Pin	Function
1	-Vin
3	Dis/Sync
7	5VA RTN
	5VB
8	5VB RTN
	15V RTN
9	5VA
	15Vout
10	15Vout
16	+Vin

**RECOMMENDED FOOTPRINT DETAILS**

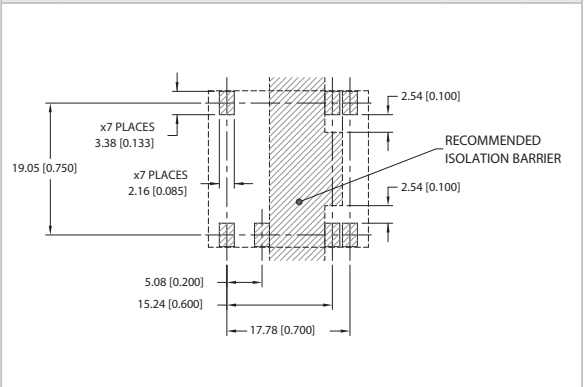

**RECOMMENDED LAYOUT**

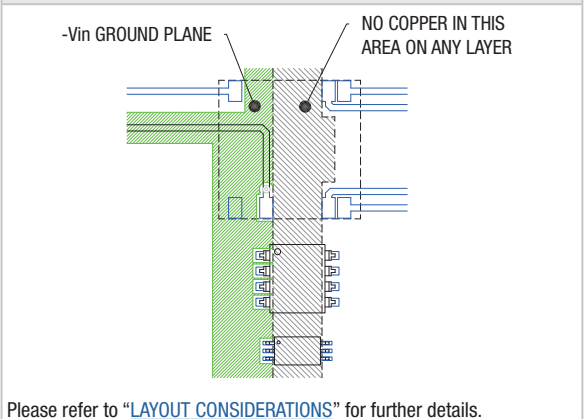

**TAPE & REEL SPECIFICATIONS**

**REEL OUTLINE DIMENSIONS**

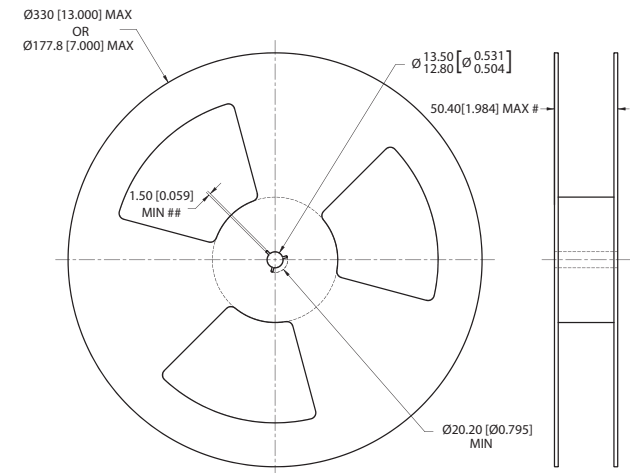

Tape & Reel specifications shall conform with current EIA-481 standard  
 Unless otherwise stated all dimensions in mm(inches)  
 Controlling dimension is mm  
 # Measured at hub  
 ## Six equally-spaced slots on 180mm/7" reel

**REEL PACKAGING DETAILS**

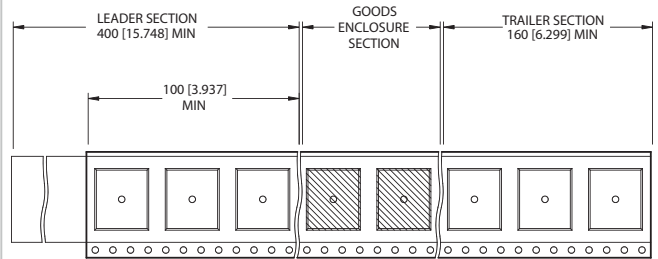

Reel Quantity: 7" - 23 or 13" - 92

**TAPE OUTLINE DIMENSIONS**

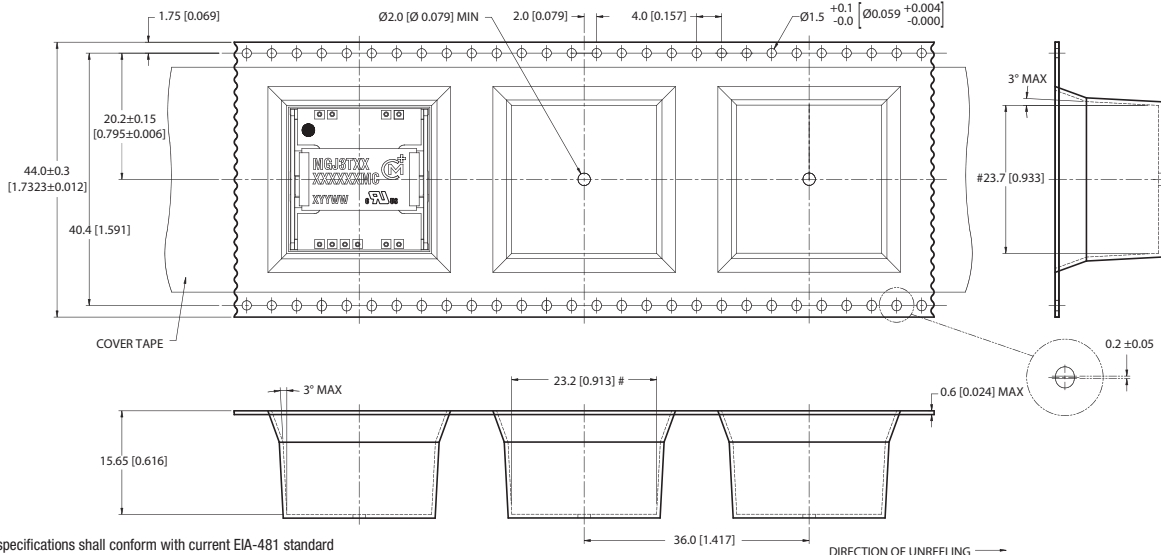

Tape & Reel specifications shall conform with current EIA-481 standard  
 Unless otherwise stated all dimensions in mm(inches) ±0.1mm (±0.004 inches)  
 Controlling dimension is mm  
 Components shall be orientated within the carrier tape as indicated  
 # Measured on a plane 0.3mm above the bottom pocket

**DISCLAIMER**

Unless otherwise stated in the datasheet, all products are designed for standard commercial and industrial applications and NOT for safety-critical and/or life-critical applications.

Particularly for safety-critical and/or life-critical applications, i.e. applications that may directly endanger or cause the loss of life, inflict bodily harm and/or loss or severe damage to equipment/property, and severely harm the environment, a prior explicit written approval from Murata is strictly required. Any use of Murata standard products for any safety-critical, life-critical or any related applications without any prior explicit written approval from Murata shall be deemed unauthorised use.

These applications include but are not limited to:

- Aircraft equipment
- Aerospace equipment
- Undersea equipment
- Power plant control equipment
- Medical equipment
- Transportation equipment ( automobiles, trains, ships, etc.)
- Traffic signal equipment
- Disaster prevention / crime prevention equipment
- Data Processing equipment

Murata makes no express or implied warranty, representation, or guarantee of suitability, fitness for any particular use/purpose and/or compatibility with any application or device of the buyer, nor does Murata assume any liability whatsoever arising out of unauthorised use of any Murata product for the application of the buyer. The suitability, fitness for any particular use/purpose and/or compatibility of Murata product with any application or device of the buyer remain to be the responsibility and liability of the buyer.

Buyer represents and agrees that it has all the necessary expertise to create and implement safeguards that anticipate dangerous consequences of failures, monitor failures and their consequences, lessen the likelihood of failures that might cause harm, and take appropriate remedial actions. Buyer will fully indemnify and hold Murata, its affiliated companies, and its representatives harmless against any damages arising out of unauthorised use of any Murata products in any safety-critical and/or life-critical applications.

Remark: Murata in this section refers to Murata Manufacturing Company and its affiliated companies worldwide including, but not limited to, Murata Power Solutions.



This product is subject to the following **operating requirements** and the **Life and Safety Critical Application Sales Policy**:

Refer to: <https://www.murata.com/en-eu/products/power/requirements>

Murata Power Solutions (Milton Keynes) Ltd. makes no representation that the use of its products in the circuits described herein, or the use of other technical information contained herein, will not infringe upon existing or future patent rights. The descriptions contained herein do not imply the granting of licenses to make, use, or sell equipment constructed in accordance therewith. Specifications are subject to change without notice.

© 2021 Murata Power Solutions (Milton Keynes) Ltd.