

## FEATURES

Frequency range: 5.9 GHz to 8.5 GHz

Typical gain of 25 dB

Low noise input

Noise figure: <1.7 dB typical from 5.9 GHz to 8.5 GHz

High linearity input

>4.0 dBm typical input third-order intercept (IIP3)

>-10.6 dBm typical input 1 dB compression point (P1dB)

Matched 50  $\Omega$  single-ended input

Matched 100  $\Omega$  differential outputs

8-lead, 2.00 mm  $\times$  2.00 mm LFCSP microwave packaging

## APPLICATIONS

Point to point microwave radios

Instrumentation

Satellite communications (SATCOM)

Phased arrays

## GENERAL DESCRIPTION

The [ADL5721](#) is a narrow-band, high performance, low noise amplifier targeting microwave radio link receiver designs. The monolithic silicon germanium (SiGe) design is optimized for microwave radio link bands ranging from 5.9 GHz to 8.5 GHz. The unique design offers a single-ended 50  $\Omega$  input impedance and provides a 100  $\Omega$  balanced differential output that is ideal for driving Analog Devices, Inc., differential downconverters and radio frequency (RF) sampling analog-to-digital converters (ADCs). This low noise amplifier (LNA) provides noise figure

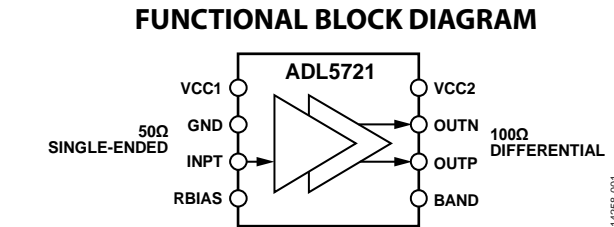

Figure 1.

performance that, in the past, required more expensive three-five (III-V) compounds process technology to achieve. This LNA uses a band switch feature to allow the input P1dB and noise figure to trade off for optimum system performance.

The [ADL5721](#) and [ADL5723](#) to [ADL5726](#) family of narrow-band LNAs are each packaged in a tiny, thermally enhanced, 2.00 mm  $\times$  2.00 mm LFCSP package. The [ADL5721](#) and [ADL5723](#) to [ADL5726](#) family operates over the temperature range of  $-40^{\circ}\text{C}$  to  $+85^{\circ}\text{C}$ .

Rev. 0

[Document Feedback](#)

Information furnished by Analog Devices is believed to be accurate and reliable. However, no responsibility is assumed by Analog Devices for its use, nor for any infringements of patents or other rights of third parties that may result from its use. Specifications subject to change without notice. No license is granted by implication or otherwise under any patent or patent rights of Analog Devices. Trademarks and registered trademarks are the property of their respective owners.

One Technology Way, P.O. Box 9106, Norwood, MA 02062-9106, U.S.A.  
Tel: 781.329.4700 ©2016 Analog Devices, Inc. All rights reserved.  
[Technical Support](#) [www.analog.com](http://www.analog.com)

## TABLE OF CONTENTS

Features .....	1	Low Band (BAND = 0 V) .....	6
Applications .....	1	High Band (BAND = 1.8 V) .....	8
Functional Block Diagram .....	1	Theory of Operation .....	10
General Description .....	1	Applications Information .....	11
Revision History .....	2	Layout .....	11
Specifications .....	3	Differential vs. Single-Ended Output .....	11
AC Specifications .....	3	Evaluation Board .....	13
DC Specifications .....	3	Initial Setup .....	13
Absolute Maximum Ratings .....	4	Results .....	13
Thermal Resistance .....	4	Basic Connections for Operation .....	14
ESD Caution .....	4	Outline Dimensions .....	15
Pin Configuration and Function Descriptions .....	5	Ordering Guide .....	15
Typical Performance Characteristics .....	6		

## REVISION HISTORY

4/16—Revision 0: Initial Version

## SPECIFICATIONS

### AC SPECIFICATIONS

$T_A = 25^\circ\text{C}$ ,  $V_{CC1} = 1.8\text{ V}$ ,  $V_{CC2} = 3.3\text{ V}$ ,  $Z_{SOURCE} = 50\ \Omega$ ,  $Z_{LOAD} = 100\ \Omega$  differential, unless otherwise noted.

Table 1.

Parameter	Test Conditions/Comments	Min	Typ	Max	Unit
FREQUENCY RANGE					
Low Band, BAND = 0 V		5.9		7.2	GHz
High Band, BAND = 1.8 V		7.1		8.5	GHz
FREQUENCY = 5.9 GHz	Low band, BAND = 0 V				
Gain (S21)			25.0		dB
Noise Figure			1.7		dB
Input Third-Order Intercept (IIP3)	$\Delta f = 1\text{ MHz}$ , input power ( $P_{IN}$ ) = -30 dBm per tone		4.3		dBm
Input 1 dB Compression Point (P1dB)			-10.6		dBm
Input Return Loss (S11)			10		dB
Output Return Loss (S22)			9		dB
FREQUENCY = 7.2 GHz	Low band, BAND = 0 V				
Gain (S21)			25.9		dB
Noise Figure			1.6		dB
Input Third-Order Intercept (IIP3)	$\Delta f = 1\text{ MHz}$ , $P_{IN} = -30\text{ dBm}$ per tone		4.0		dBm
Input 1 dB Compression Point (P1dB)			-9.3		dBm
Input Return Loss (S11)			10		dB
Output Return Loss (S22)			10		dB
FREQUENCY = 8.5 GHz	High band, BAND = 1.8 V				
Gain (S21)			24.6		dB
Noise Figure			1.5		dB
Input Third-Order Intercept (IIP3)	$\Delta f = 1\text{ MHz}$ , $P_{IN} = -30\text{ dBm}$ per tone		5.7		dBm
Input 1 dB Compression Point (P1dB)			-8.6		dBm
Input Return Loss (S11)			10		dB
Output Return Loss (S22)			10		dB

### DC SPECIFICATIONS

Table 2.

Parameter	Test Conditions/Comments	Min	Typ	Max	Unit
POWER INTERFACE					
VCC1 Voltage		1.65	1.8	1.95	V
VCC2 Voltage		3.1	3.3	3.5	V
Quiescent Current vs. Temperature					
VCC1	$T_A = 25^\circ\text{C}$		11.6		mA
	$-40^\circ\text{C} \leq T_A \leq +85^\circ\text{C}$		12.1		mA
VCC2	$T_A = 25^\circ\text{C}$		74.1		mA
	$-40^\circ\text{C} \leq T_A \leq +85^\circ\text{C}$		74.4		mA

## ABSOLUTE MAXIMUM RATINGS

Table 3.

Parameter	Rating
Supply Voltages	
VCC1	2.25 V
VCC2	4.1 V
Maximum Junction Temperature	150°C
Operating Temperature Range	−40°C to +85°C
Storage Temperature Range	−55°C to +125°C
Lead Temperature Range (Soldering 60 sec)	−65°C to +150°C

Stresses at or above those listed under Absolute Maximum Ratings may cause permanent damage to the product. This is a stress rating only; functional operation of the product at these or any other conditions above those indicated in the operational section of this specification is not implied. Operation beyond the maximum operating conditions for extended periods may affect product reliability.

## THERMAL RESISTANCE

$\theta_{JA}$  is thermal resistance, junction to ambient (°C/W),  $\theta_{JB}$  is thermal resistance, junction to board (°C/W), and  $\theta_{JC}$  is thermal resistance, junction to case (°C/W).

Table 4. Thermal Resistance

Package Type	$\theta_{JA}^1$	$\theta_{JB}^1$	$\theta_{JC}^1$	Unit
8-Lead LFCSP	39.90	23.88	3.71	°C/W

<sup>1</sup> See JEDEC standard JESD51-2 for additional information on optimizing the thermal impedance for a printed circuit board (PCB) with 3 × 4 vias.

## ESD CAUTION



### ESD (electrostatic discharge) sensitive device.

Charged devices and circuit boards can discharge without detection. Although this product features patented or proprietary protection circuitry, damage may occur on devices subjected to high energy ESD. Therefore, proper ESD precautions should be taken to avoid performance degradation or loss of functionality.

## PIN CONFIGURATION AND FUNCTION DESCRIPTIONS

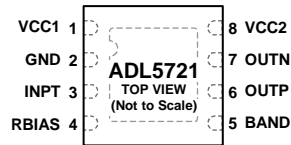

### NOTES

1. THE EXPOSED PAD MUST BE SOLDERED TO A LOW IMPEDANCE GROUND PLANE.
2. THE DEVICE NUMBER ON THE FIGURE DOES NOT INDICATE THE LABEL ON THE PACKAGE. REFER TO THE PIN 1 INDICATOR FOR THE PIN LOCATIONS.

14258-002

Figure 2. Pin Configuration

Table 5. Pin Function Descriptions

Pin No.	Mnemonic	Description
1	VCC1	1.8 V Power Supply. It is recommended to place the decoupling capacitors as close to this pin as possible.
2	GND	Ground.
3	INPT	RF Input. This pin is a 50 $\Omega$ single-ended input.
4	RBIAS	Resistor Bias. For typical operation, connect a 442 $\Omega$ resistor from RBIAS to GND. It is recommended to place the RBIAS resistor as close to the pin as possible.
5	BAND	Band Select Control. Select a logic low of 0 V for the lower frequency range from 5.9 GHz to 7.2 GHz. Select a logic high of 1.8 V for the higher frequency range from 7.1 GHz to 8.5 GHz.
6, 7	OUTP, OUTN	RF Outputs. These pins are 100 $\Omega$ differential outputs.
8	VCC2 EPAD (EP)	3.3 V Power Supply. It is recommended to place the decoupling capacitors as close to this pin as possible. Exposed Pad. The exposed pad must be soldered to a low impedance ground plane.

# TYPICAL PERFORMANCE CHARACTERISTICS

$T_A = 25^\circ\text{C}$ ,  $V_{CC1} = 1.8\text{ V}$ ,  $V_{CC2} = 3.3\text{ V}$ ,  $Z_{SOURCE} = 50\ \Omega$ ,  $Z_{LOAD} = 100\ \Omega$  differential, unless otherwise noted.

## LOW BAND (BAND = 0 V)

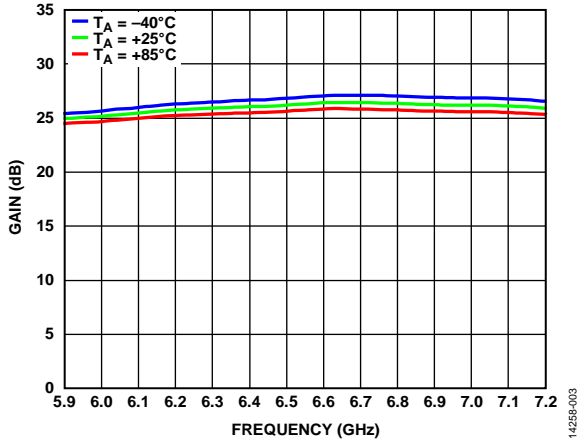

Figure 3. Gain vs. Frequency for Various Temperatures

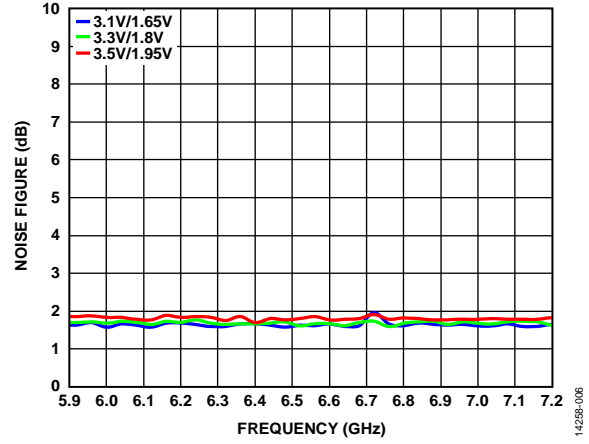

Figure 6. Noise Figure vs. Frequency for Various Supply Voltages

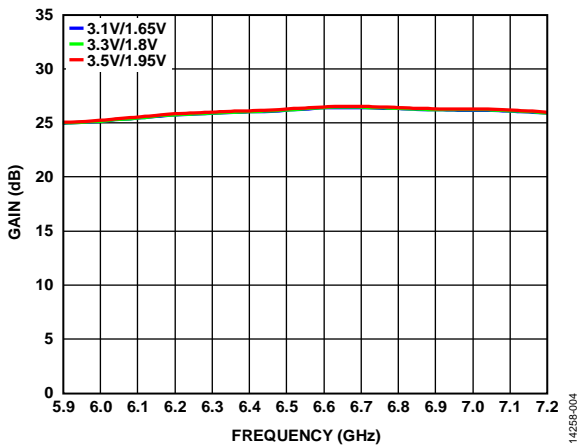

Figure 4. Gain vs. Frequency for Various Supply Voltages

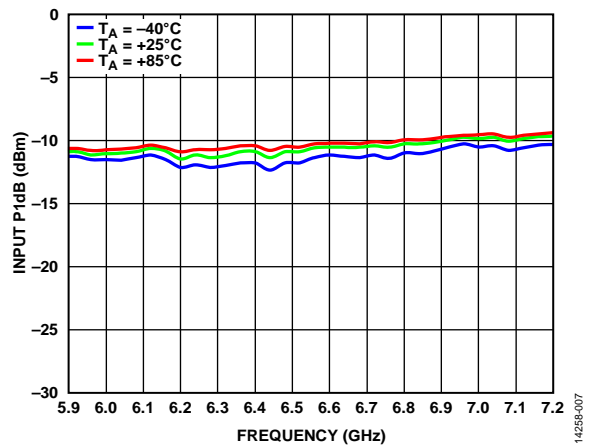

Figure 7. Input P1dB vs. Frequency for Various Temperatures

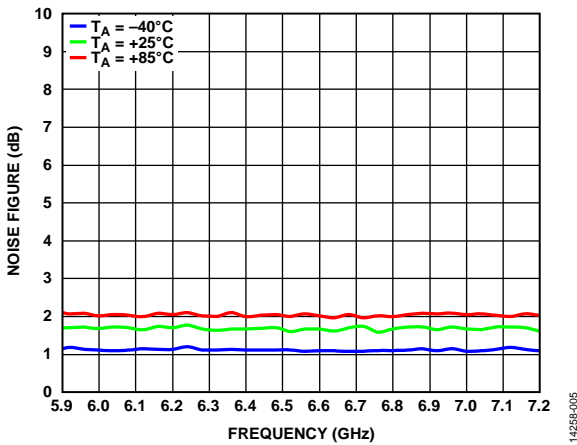

Figure 5. Noise Figure vs. Frequency for Various Temperatures

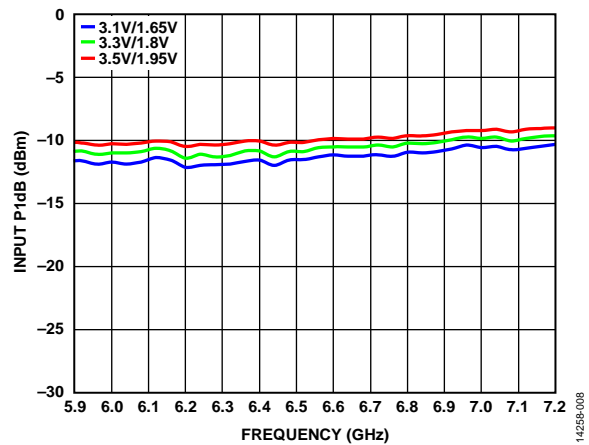

Figure 8. Input P1dB vs. Frequency for Various Supply Voltages

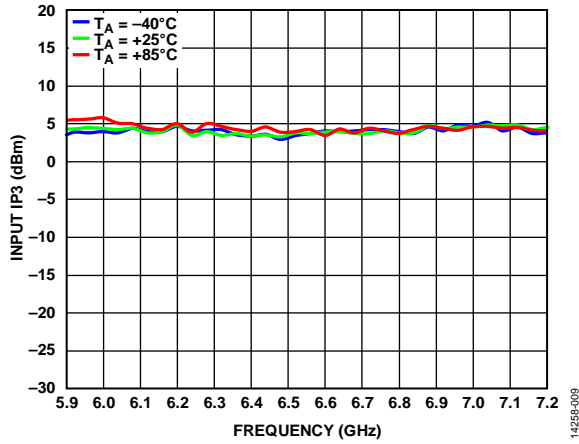

Figure 9. Input IP3 vs. Frequency for Various Temperatures

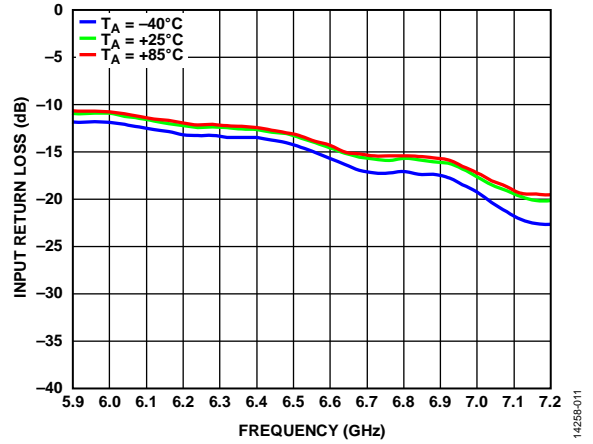

Figure 11. Input Return Loss vs. Frequency for Various Temperatures

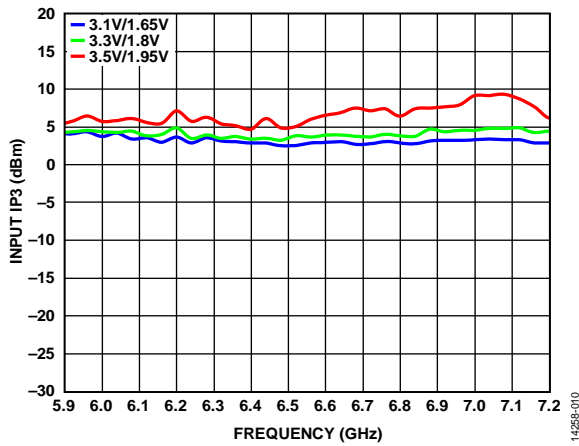

Figure 10. Input IP3 vs. Frequency for Various Supply Voltages

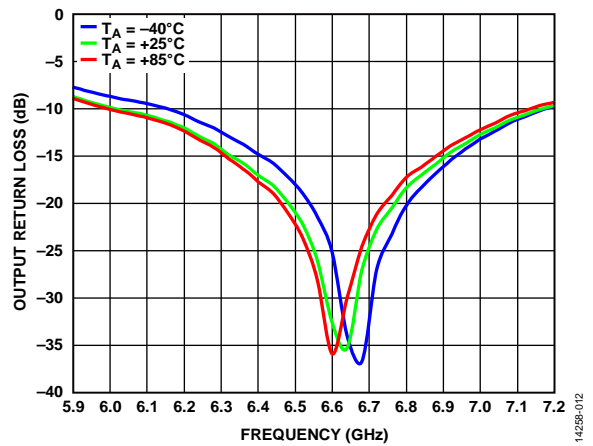

Figure 12. Output Return Loss vs. Frequency for Various Temperatures

HIGH BAND (BAND = 1.8 V)

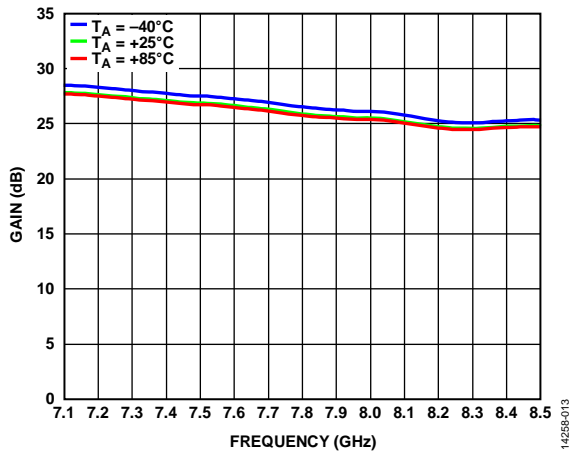

Figure 13. Gain vs. Frequency for Various Temperatures

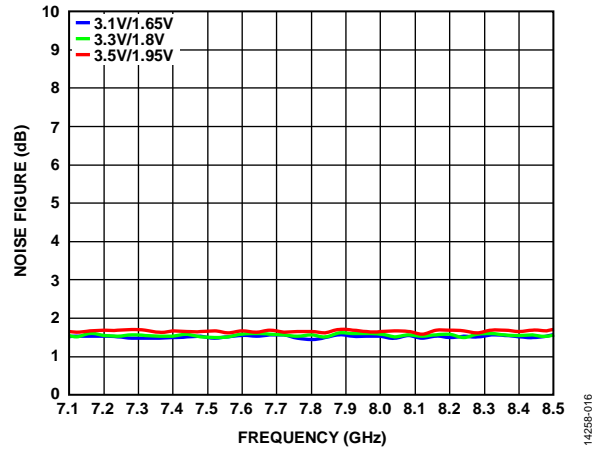

Figure 16. Noise Figure vs. Frequency for Various Supply Voltages

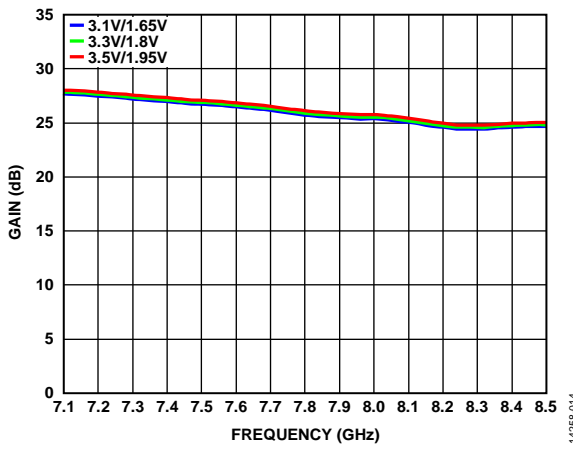

Figure 14. Gain vs. Frequency for Various Supply Voltages

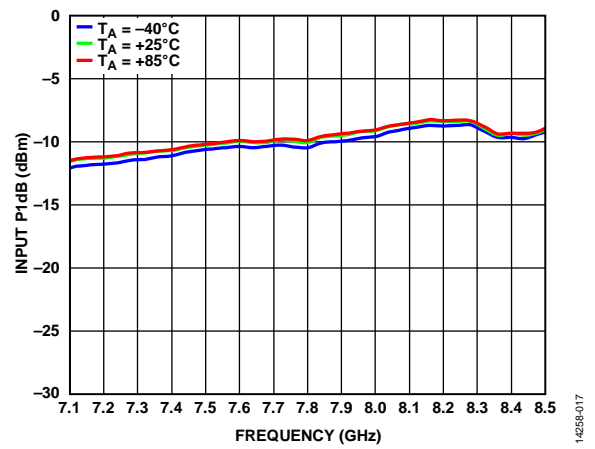

Figure 17. Input P1dB vs. Frequency for Various Temperatures

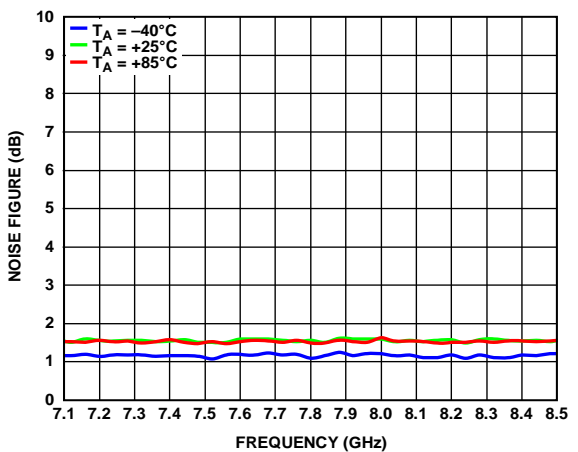

Figure 15. Noise Figure vs. Frequency for Various Temperatures

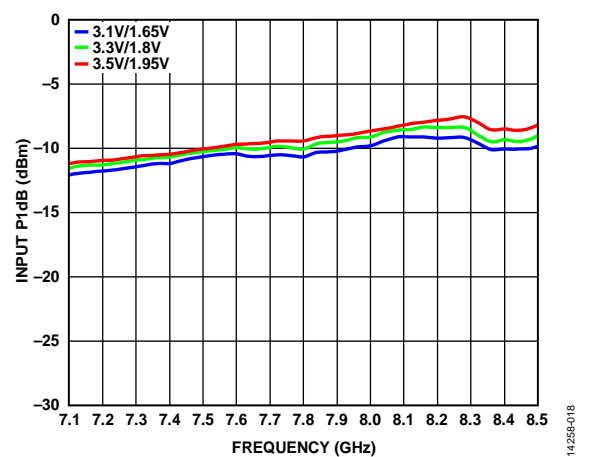

Figure 18. Input P1dB vs. Frequency for Various Supply Voltages



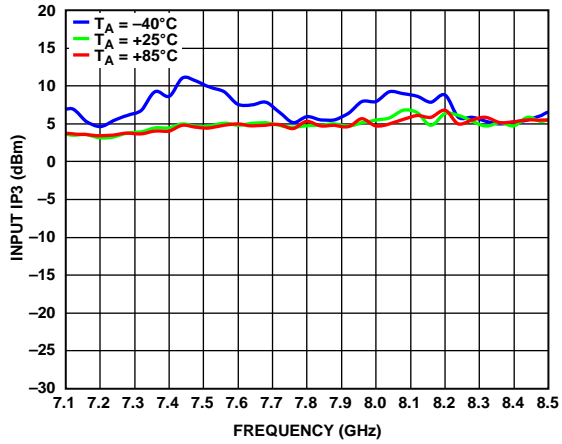

Figure 19. Input IP3 vs. Frequency for Various Temperatures

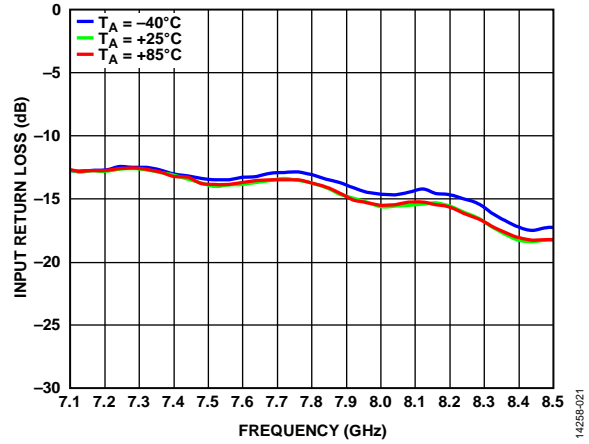

Figure 21. Input Return Loss vs. Frequency for Various Temperatures

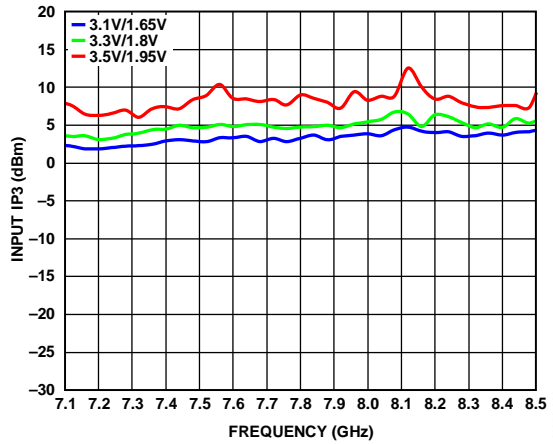

Figure 20. Input IP3 vs. Frequency for Various Supply Voltages

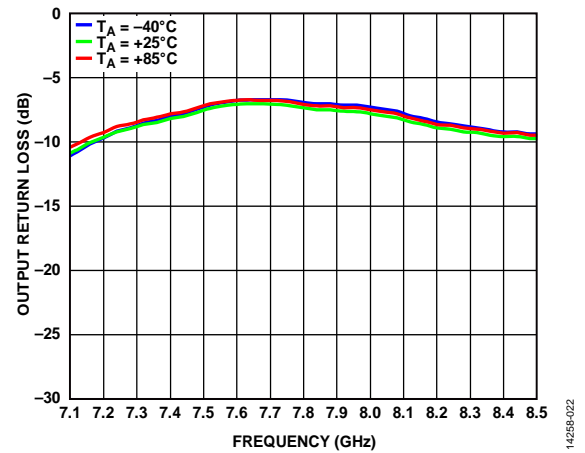

Figure 22. Output Return Loss vs. Frequency for Various Temperatures

## THEORY OF OPERATION

The [ADL5721](#) is a narrow-band, high performance, low noise amplifier targeting microwave radio link receiver designs. The monolithic SiGe design is optimized for microwave radio link bands ranging from 5.9 GHz to 8.5 GHz.

The unique design of the [ADL5721](#) offers a single-ended 50  $\Omega$  input impedance and provides a 100  $\Omega$  balanced differential output. This LNA is ideal for driving Analog Devices differential downconverters and RF sampling ADCs.

The [ADL5721](#) provides cost-effective noise figure performance without requiring more expensive III-V compounds process technology.

This LNA uses a band switch feature to allow the input P1dB and noise figure to trade off for optimum system performance. The BAND pin allows the user to select between two frequency ranges. A logic low of 0 V on the BAND pin selects the lower frequency range from 5.9 GHz to 7.2 GHz, whereas a logic high of 1.8 V selects the higher frequency range from 7.1 GHz to 8.5 GHz.

The [ADL5721](#) is available in an 8-lead, 2.00 mm  $\times$  2.00 mm LFCSP package, and operates over the temperature range of  $-40^{\circ}\text{C}$  to  $+85^{\circ}\text{C}$ .

# APPLICATIONS INFORMATION

## LAYOUT

Solder the exposed pad on the underside of the ADL5721 to a low thermal and electrical impedance ground plane. This pad is typically soldered to an exposed opening in the solder mask on the evaluation board. Connect these ground vias to all other ground layers on the evaluation board to maximize heat dissipation from the device package.

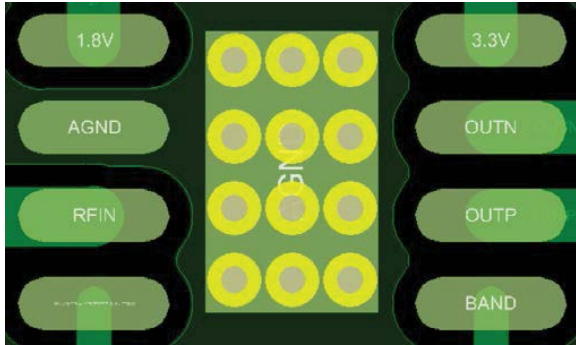

Figure 23. Evaluation Board Layout for the ADL5721 Package

## DIFFERENTIAL vs. SINGLE-ENDED OUTPUT

This section provides the test results that compare the ADL5721 using a differential vs. a single-ended output. When using the device as a single-ended output, use the RFOP output of the evaluation board and terminate RFON to 50 Ω. Note that the converse can be done as well; however, doing so produces slightly different results from the plots shown in this section, caused by some amplitude imbalance between the two differential ports, RFOP and RFON. The output trace and connector loss were not deembedded for these measurements.

Note that this performance is typical and not guaranteed.

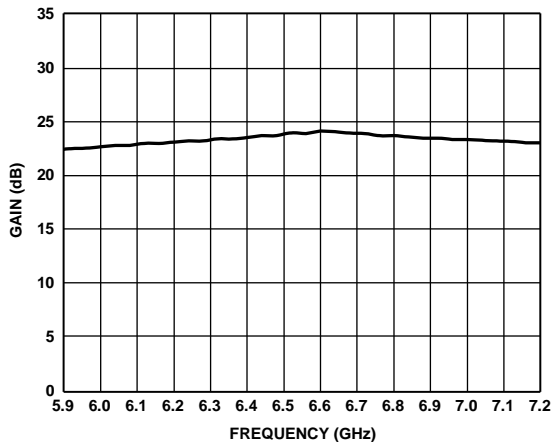

Figure 24. Gain vs. Frequency, BAND = 0 V

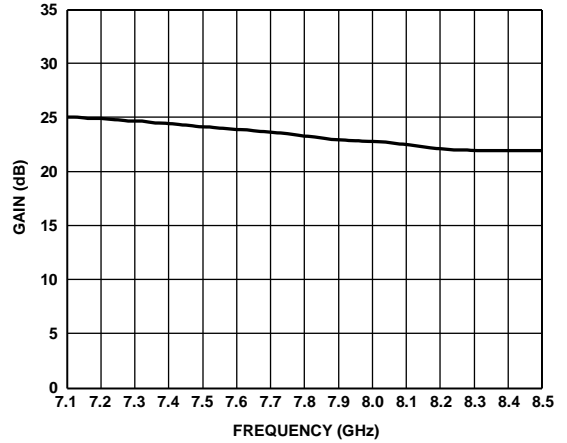

Figure 25. Gain vs. Frequency, BAND = 1.8 V

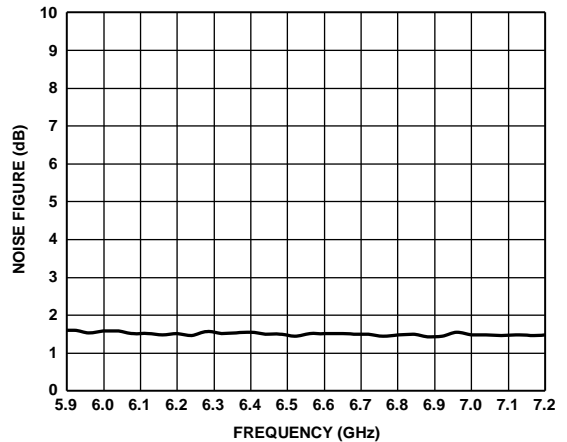

Figure 26. Noise Figure vs. Frequency, BAND = 0 V

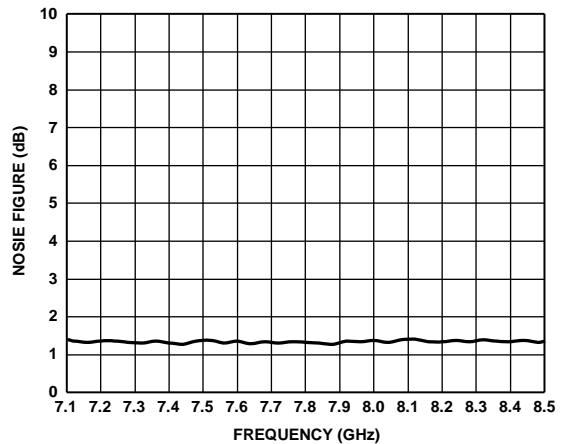

Figure 27. Noise Figure vs. Frequency, BAND = 1.8 V

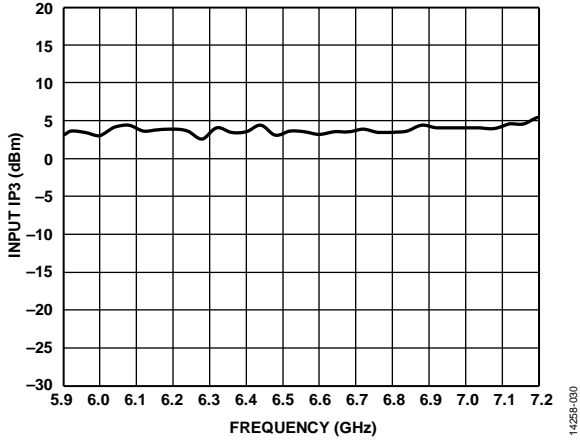

Figure 28. Input IP3 vs. Frequency, BAND = 0 V

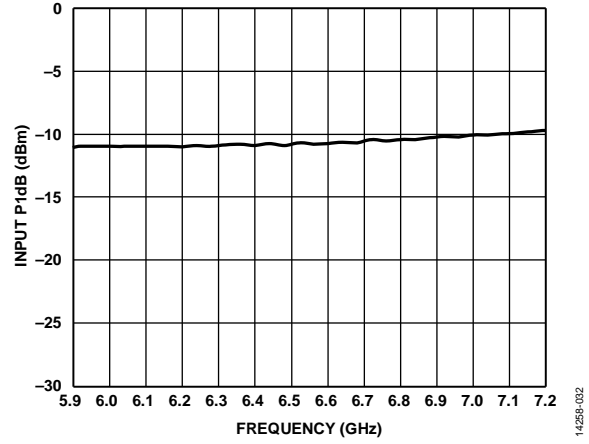

Figure 30. Input P1dB vs. Frequency, BAND = 0 V

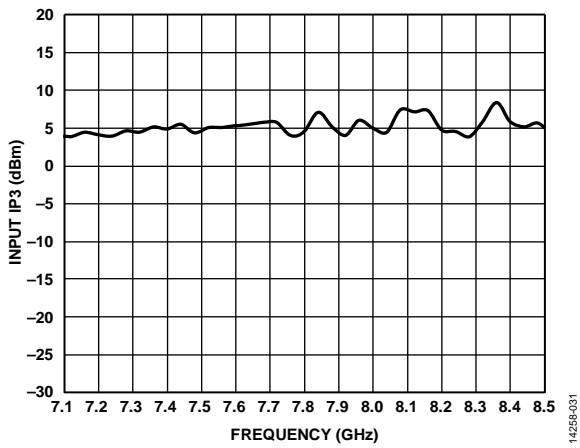

Figure 29. Input IP3 vs. Frequency, BAND = 1.8 V

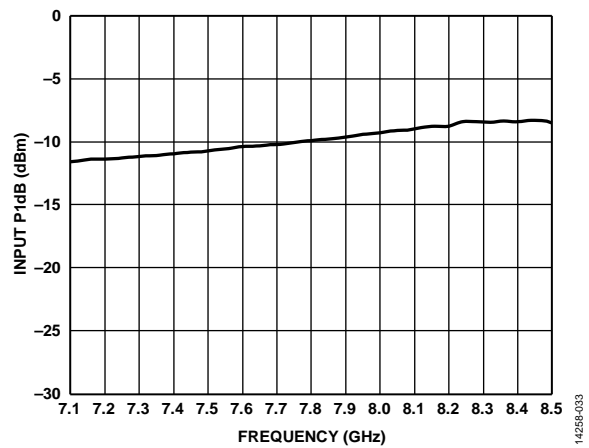

Figure 31. Input P1dB vs. Frequency, BAND = 1.8 V

### EVALUATION BOARD

The **ADL5721-EVALZ** comes with an **ADL5721** chip. It supports a single 5 V supply for ease of use. For 5 V operation, the 3.3 V and 1.8 V test loops are for evaluation purposes only. When the 3.3 V and 1.8 V supply is used, remove the R1 and R2 resistors from the evaluation board. Figure 34 shows a picture of the **ADL5721-EVALZ** lab bench setup.

The band switch feature allows the input P1dB and noise figure to trade off for optimum system performance. For the lower frequency band (BAND = 0 V), short Pin 1 and Pin 2 of the P1 connector. For the higher frequency band (BAND = 1.8 V), open Pin 1 and Pin 2 of the P1 connector to obtain better system performance.

### INITIAL SETUP

To set up the **ADL5721-EVALZ**, take the following steps:

1. Power up the **ADL5721-EVALZ** with a 5 V dc supply. The supply current of the evaluation board is approximately 88 mA, which is a combination of the VCC1 (1.8 V) and the VCC2 (3.3 V) currents.
2. Connect the signal generator to the input of the **ADL5721-EVALZ**.
3. Connect RFOP and RFON to a 180° hybrid that can work within the 5.9 GHz to 8.5 GHz frequency range.
4. Connect the difference output of the hybrid to the spectrum analyzer. Terminate the sum port of the hybrid to 50 Ω.

See Figure 34 for the **ADL5721-EVALZ** lab bench setup.

### RESULTS

Figure 32 and Figure 33 show the expected results when testing the **ADL5721-EVALZ** using the Rev. A version of the evaluation board and its software. Note that future iterations of the software may produce different results. See the **ADL5721** product page for the most recent software version.

Figure 32 shows the results of the differential output for an input of 7.2 GHz at -15 dBm with a BAND = 0 V, with Pin 1 and Pin 2 of the P1 connector shorted. The hybrid and board loss were not deembedded.

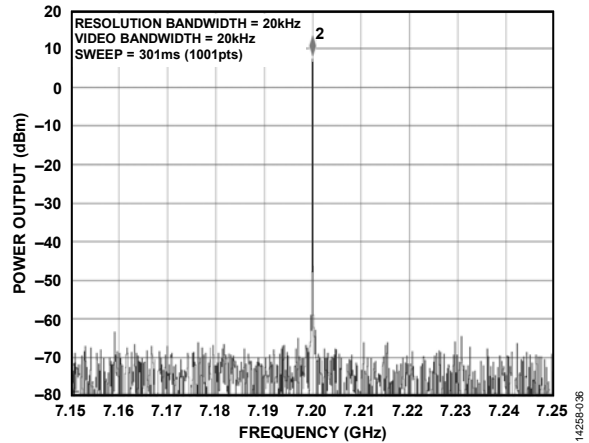

Figure 32. Results of the **ADL5721** with an Input of 7.2 GHz at -15 dBm, BAND = 0 V

Figure 33 shows the results of the differential output for an input of 8.5 GHz at -15 dBm with a BAND = 1.8 V, with Pin 1 and Pin 2 of the P1 connector open. The hybrid and board loss were not deembedded.

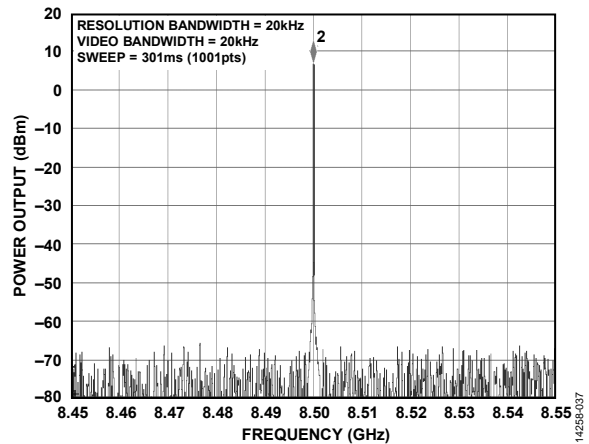

Figure 33. Results of the **ADL5721** with an Input of 8.5 GHz at -15 dBm, BAND = 1.8 V

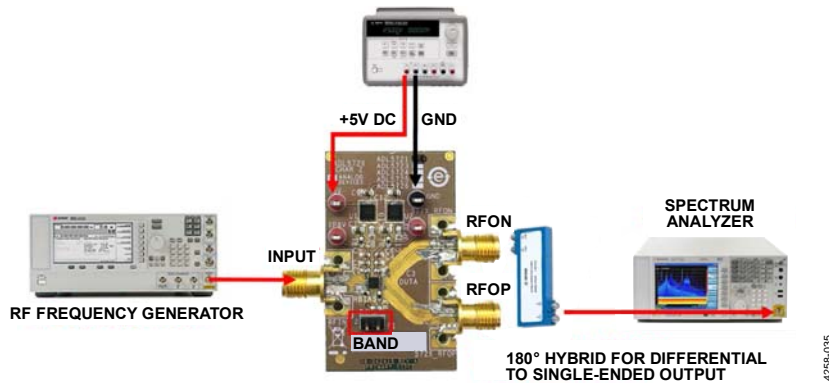

Figure 34. **ADL5721-EVALZ** Lab Bench Setup

**BASIC CONNECTIONS FOR OPERATION**

Figure 35 shows the basic connections for operating the [ADL5721](#) as it is implemented on the evaluation board of the device.

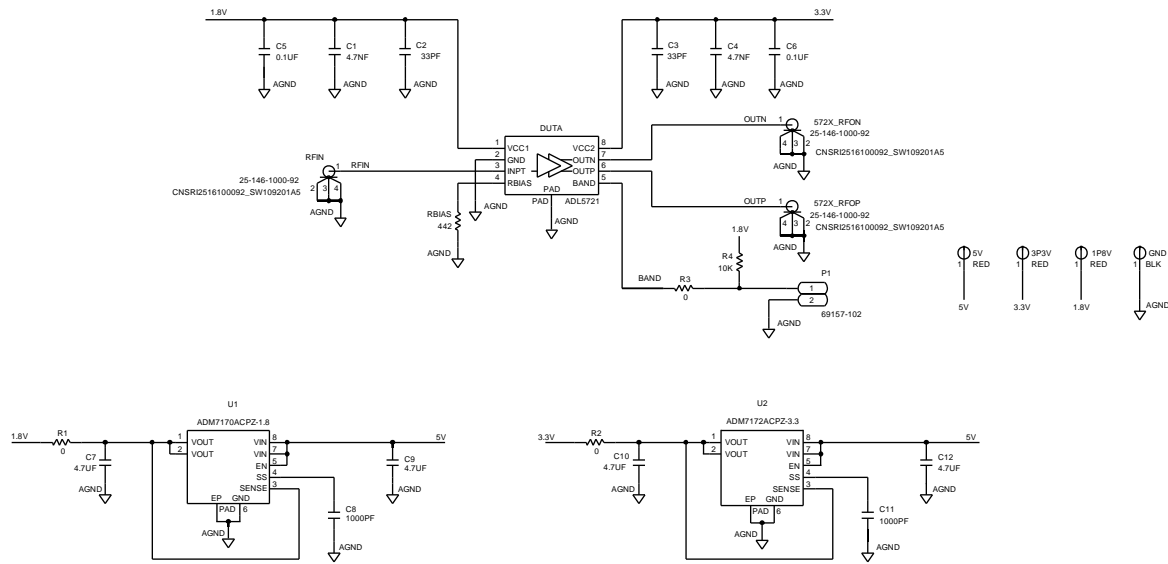
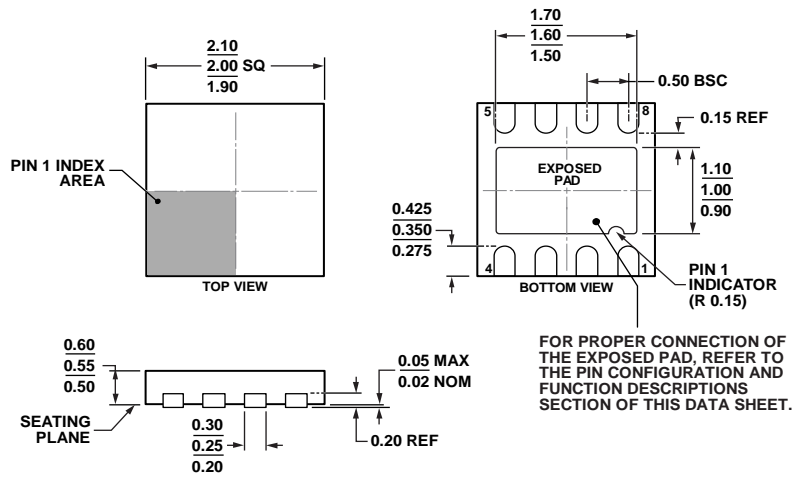

Figure 35. Evaluation Board Schematic

**Table 6. Evaluation Board Configuration Options**

Component	Function	Default Condition
3P3V, 1P8V, GND, 5V	Power supplies and ground.	Not applicable
RFIN, 572X_RFOP, 572x_RFON, BAND	Input, output, and data.	Not applicable
RBIAS	442 Ω for RBIAS.	RBIAS = 442 Ω (0402)
R1, R2	1.8 V and 3.3 V regulator connections.	R1, R2 = 0 Ω (0402)
R3	Band select.	R3 = 0 Ω (0603)
R4	Pull-up or pull-down resistor.	R4 = 10 kΩ (0402)
C1 to C12	The capacitors provide the required decoupling of the supply related pins.	C1, C4 = 4.7 nF (0402), C2, C3 = 33 pF (0402), C5, C6 = 0.1 μF (0402), C7, C9, C10, C12 = 4.7 μF (0603), C8, C11 = 1000 pF (0603)
P1	Jumper to change bands, 2-pin jumper.	Not applicable
U1	<a href="#">ADM7170ACPZ-1.8</a> 1.8 V regulator.	Not applicable
U2	<a href="#">ADM7172ACPZ-3.3</a> 3.3 V regulator.	Not applicable
DUTA	<a href="#">ADL5721</a> device under test (DUT).	Not applicable

OUTLINE DIMENSIONS



01-14-2013-C

Figure 36. 8-Lead Lead Frame Chip Scale Package [LFCSP]  
 2.00 mm x 2.00 mm Body and 0.55 mm Package Height  
 (CP-8-10)  
 Dimensions shown in millimeters

ORDERING GUIDE

Model <sup>1</sup>	Temperature Range	Package Description	Package Option
ADL5721ACPZN	-40°C to +85°C	8-Lead Lead Frame Chip Scale Package [LFCSP]	CP-8-10
ADL5721ACPZN-R7	-40°C to +85°C	8-Lead Lead Frame Chip Scale Package [LFCSP]	CP-8-10
ADL5721-EVALZ		Evaluation Board	

<sup>1</sup> Z = RoHS-Compliant Part.