

FEATURES

- High dynamic range, dual DACs
- Low noise and intermodulation distortion
- Single carrier WCDMA ACLR = 80 dBc at 61.44 MHz IF
- Innovative switching output stage permits useable outputs beyond Nyquist frequency
- LVC MOS inputs with dual-port or optional interleaved single-port operation
- Differential analog current outputs are programmable from 8.6 mA to 31.7 mA full scale
- Auxiliary 10-bit current DACs with source/sink capability for external offset nulling
- Internal 1.2 V precision reference voltage source
- Operates from 1.8 V and 3.3 V supplies
- 315 mW power dissipation
- Small footprint, Pb-free, 72-pin LFCSP

APPLICATIONS

- Wireless infrastructure:**
 - WCDMA, CDMA2000, TD-SCDMA, WiMAX
- Wideband communications:**
 - LMDS/MMDS, point-to-point
- Instrumentation:**
 - RF signal generators, arbitrary waveform generators

GENERAL DESCRIPTION

The AD9741/AD9743/AD9745/AD9746/AD9747 are pin-compatible, high dynamic range, dual digital-to-analog converters (DACs) with 8-/10-/12-/14-/16-bit resolutions and sample rates of up to 250 MSPS. The devices include specific features for direct conversion transmit applications, including gain and offset compensation, and they interface seamlessly with analog quadrature modulators, such as the ADL5370.

A proprietary, dynamic output architecture permits synthesis of analog outputs even above Nyquist by shifting energy away from the fundamental and into the image frequency.

Full programmability is provided through a serial peripheral interface (SPI) port. In addition, some pin-programmable features are offered for those applications without a controller.

PRODUCT HIGHLIGHTS

1. Low noise and intermodulation distortion (IMD) enables high quality synthesis of wideband signals.
2. Proprietary switching output for enhanced dynamic performance.
3. Programmable current outputs and dual auxiliary DACs provide flexibility and system enhancements.

FUNCTIONAL BLOCK DIAGRAM

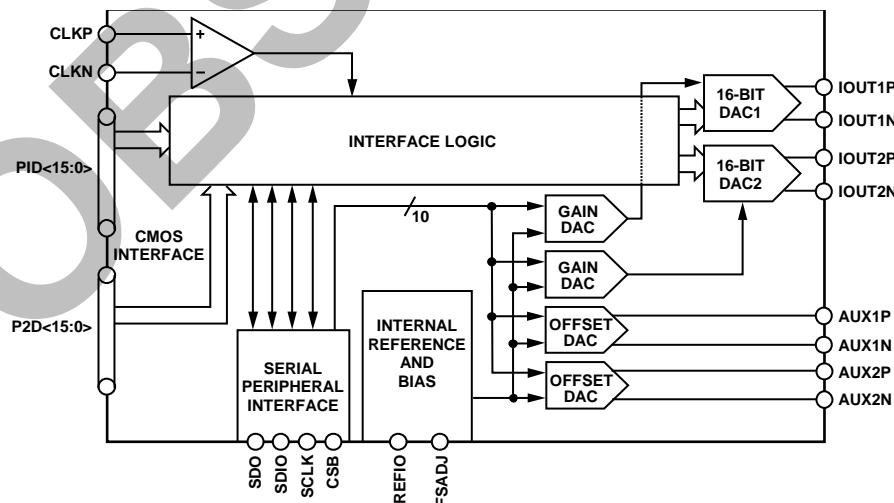

Figure 1.

Rev. B

[Document Feedback](#)

Information furnished by Analog Devices is believed to be accurate and reliable. However, no responsibility is assumed by Analog Devices for its use, nor for any infringements of patents or other rights of third parties that may result from its use. Specifications subject to change without notice. No license is granted by implication or otherwise under any patent or patent rights of Analog Devices. Trademarks and registered trademarks are the property of their respective owners.

One Technology Way, P.O. Box 9106, Norwood, MA 02062-9106, U.S.A.
 Tel: 781.329.4700 ©2007–2014 Analog Devices, Inc. All rights reserved.
[Technical Support](#) www.analog.com

TABLE OF CONTENTS

| | | | |
|--|----|--|----|
| Features | 1 | Instruction Byte | 18 |
| Applications | 1 | MSB/LSB Transfers | 19 |
| General Description | 1 | Serial Interface Port Pin Descriptions | 19 |
| Product Highlights | 1 | SPI Register Map | 20 |
| Functional Block Diagram | 1 | SPI Register Descriptions | 21 |
| Revision History | 2 | Digital Inputs and Outputs | 22 |
| Specifications | 3 | Input Data Timing | 22 |
| DC Specifications | 3 | Dual-Port Mode Timing | 22 |
| AC Specifications | 5 | Single-Port Mode Timing | 22 |
| Digital and Timing Specifications | 7 | SPI Port, Reset, and Pin Mode | 22 |
| Absolute Maximum Ratings | 8 | Driving the DAC Clock Input | 23 |
| Thermal Resistance | 8 | Full-Scale Current Generation | 23 |
| ESD Caution | 8 | DAC Transfer Function | 24 |
| Pin Configurations and Function Descriptions | 9 | Analog Modes of Operation | 24 |
| Typical Performance Characteristics | 14 | Auxiliary DACS | 25 |
| Terminology | 17 | Power Dissipation | 25 |
| Theory of Operation | 18 | Outline Dimensions | 27 |
| Serial Peripheral Interface | 18 | Ordering Guide | 27 |
| General Operation of the Serial Interface | 18 | | |

REVISION HISTORY

1/14—Rev. 0 to Rev. A

| | |
|----------------------------------|----|
| Changes to Table 15 | 21 |
| Updated Outline Dimensions | 27 |
| Changes to Ordering Guide | 27 |

5/07—Revision 0: Initial Version

SPECIFICATIONS

DC SPECIFICATIONS

T_{MIN} to T_{MAX} , $AVDD33 = 3.3$ V, $DVDD33 = 3.3$ V, $DVDD18 = 1.8$ V, $CVDD18 = 1.8$ V, $I_{FS} = 20$ mA, full-scale digital input, maximum sample rate, unless otherwise noted.

Table 1. AD9741, AD9743, and AD9745

| Parameter | AD9741 | | | AD9743 | | | AD9745 | | | Unit |
|--|--------|-----|------|--------|-----|------|--------|-----|------|--------|
| | Min | Typ | Max | Min | Typ | Max | Min | Typ | Max | |
| RESOLUTION | 8 | | | 10 | | | 12 | | | Bits |
| ACCURACY | | | | | | | | | | |
| Differential Nonlinearity (DNL) | ±0.03 | | | ±0.05 | | | ±0.13 | | | LSB |
| Integral Nonlinearity (INL) | ±0.05 | | | ±0.10 | | | ±0.25 | | | LSB |
| MAIN DAC OUTPUTS | | | | | | | | | | |
| Offset Error | ±0.001 | | | ±0.001 | | | ±0.001 | | | %FSR |
| Offset Error Temperature Coefficient | 1.0 | | | 1.0 | | | 1.0 | | | ppm/°C |
| Gain Error | ±2.0 | | | ±2.0 | | | ±2.0 | | | %FSR |
| Gain Error Temperature Coefficient | 100 | | | 100 | | | 100 | | | ppm/°C |
| Gain Matching (DAC1 to DAC2) | ±1.0 | | | ±1.0 | | | ±1.0 | | | %FSR |
| Full-Scale Output Current | 8.6 | | 31.7 | 8.6 | | 31.7 | 8.6 | | 31.7 | mA |
| Output Compliance Voltage | -1.0 | | +1.0 | -1.0 | | +1.0 | -1.0 | | +1.0 | V |
| Output Resistance | 10 | | | 10 | | | 10 | | | MΩ |
| AUXILIARY DAC OUTPUTS | | | | | | | | | | |
| Resolution | 10 | | | 10 | | | 10 | | | Bits |
| Full-Scale Output Current | -2.0 | | +2.0 | -2.0 | | +2.0 | -2.0 | | +2.0 | mA |
| Output Compliance Voltage Range—Sink Current | 0.8 | | 1.6 | 0.8 | | 1.6 | 0.8 | | 1.6 | V |
| Output Compliance Voltage Range—Source Current | 0 | | 1.6 | 0 | | 1.6 | 0 | | 1.6 | V |
| Output Resistance | 1 | | | 1 | | | 1 | | | MΩ |
| Monotonicity | 10 | | | 10 | | | 10 | | | Bits |
| REFERENCE INPUT/OUTPUT | | | | | | | | | | |
| Output Voltage | 1.2 | | | 1.2 | | | 1.2 | | | V |
| Output Voltage Temperature Coefficient | 10 | | | 10 | | | 10 | | | ppm/°C |
| External Input Voltage Range | 1.15 | | 1.3 | 1.15 | | 1.3 | 1.15 | | 1.3 | V |
| Input or Output Resistance | 5 | | | 5 | | | 5 | | | kΩ |
| POWER SUPPLY VOLTAGES | | | | | | | | | | |
| AVDD33, DVDD33 | 3.13 | | 3.47 | 3.13 | | 3.47 | 3.13 | | 3.47 | V |
| CVDD18, DVDD18 | 1.70 | | 1.90 | 1.70 | | 1.90 | 1.70 | | 1.90 | V |
| POWER SUPPLY CURRENTS | | | | | | | | | | |
| I_{AVDD33} | 56 | | 60 | 56 | | 60 | 56 | | 60 | mA |
| I_{DVDD33} | 10 | | 14 | 10 | | 14 | 11 | | 15 | mA |
| I_{CVDD18} | 18 | | 22 | 18 | | 22 | 18 | | 22 | mA |
| I_{DVDD18} | 28 | | 32 | 29 | | 33 | 30 | | 34 | mA |
| POWER DISSIPATION | | | | | | | | | | |
| $f_{DAC} = 250$ MSPS, $f_{OUT} = 20$ MHz | 300 | | 345 | 300 | | 345 | 305 | | 350 | mW |
| DAC Outputs Disabled | 115 | | | 115 | | | 120 | | | mW |
| Full Device Power-Down | 3 | | | 3 | | | 3 | | | mW |
| OPERATING TEMPERATURE | -40 | | +85 | -40 | | +85 | -40 | | +85 | °C |

T_{MIN} to T_{MAX} , AVDD33 = 3.3 V, DVDD33 = 3.3 V, DVDD18 = 1.8 V, CVDD18 = 1.8 V, I_{FS} = 20 mA, full-scale digital input, maximum sample rate, unless otherwise noted. The AD9745 is repeated in Table 2 so the user can compare it with all other parts.

Table 2. AD9745, AD9746, and AD9747

| Parameter | AD9745 | | | AD9746 | | | AD9747 | | | Unit |
|--|--------|-----|------|--------|-----|------|--------|-----|------|--------|
| | Min | Typ | Max | Min | Typ | Max | Min | Typ | Max | |
| RESOLUTION | 12 | | | 14 | | | 16 | | | Bits |
| ACCURACY | | | | | | | | | | |
| Differential Nonlinearity (DNL) | ±0.13 | | | ±0.5 | | | ±2.0 | | | LSB |
| Integral Nonlinearity (INL) | ±0.25 | | | ±1.0 | | | ±4.0 | | | LSB |
| MAIN DAC OUTPUTS | | | | | | | | | | |
| Offset Error | ±0.001 | | | ±0.001 | | | ±0.001 | | | %FSR |
| Offset Error Temperature Coefficient | 0.1 | | | 0.1 | | | 0.1 | | | ppm/°C |
| Gain Error | ±2.0 | | | ±2.0 | | | ±2.0 | | | %FSR |
| Gain Error Temperature Coefficient | 100 | | | 100 | | | 100 | | | ppm/°C |
| Gain Matching (DAC1 to DAC2) | ±1.0 | | | ±1.0 | | | ±1.0 | | | %FSR |
| Full-Scale Output Current | 8.6 | | 31.7 | 8.6 | | 31.7 | 8.6 | | 31.7 | mA |
| Output Compliance Voltage | -1.0 | | +1.0 | -1.0 | | +1.0 | -1.0 | | +1.0 | V |
| Output Resistance | 10 | | | 10 | | | 10 | | | MΩ |
| AUXILIARY DAC OUTPUTS | | | | | | | | | | |
| Resolution | 10 | | | 10 | | | 10 | | | Bits |
| Full-Scale Output Current | -2.0 | | +2.0 | -2.0 | | +2.0 | -2.0 | | +2.0 | mA |
| Output Compliance Voltage Range—Sink Current | 0.8 | | 1.6 | 0.8 | | 1.6 | 0.8 | | 1.6 | V |
| Output Compliance Voltage Range—Source Current | 0 | | 1.6 | 0 | | 1.6 | 0 | | 1.6 | V |
| Output Resistance | 1 | | | 1 | | | 1 | | | MΩ |
| Monotonicity | 10 | | | 10 | | | 10 | | | Bits |
| REFERENCE INPUT/OUTPUT | | | | | | | | | | |
| Output Voltage | 1.2 | | | 1.2 | | | 1.2 | | | V |
| Output Voltage Temperature Coefficient | 10 | | | 10 | | | 10 | | | ppm/°C |
| External Input Voltage Range | 1.15 | | 1.3 | 1.15 | | 1.3 | 1.15 | | 1.3 | V |
| Input or Output Resistance | 5 | | | 5 | | | 5 | | | kΩ |
| POWER SUPPLY VOLTAGES | | | | | | | | | | |
| AVDD33, DVDD33 | 3.13 | | 3.47 | 3.13 | | 3.47 | 3.13 | | 3.47 | V |
| CVDD18, DVDD18 | 1.70 | | 1.90 | 1.70 | | 1.90 | 1.70 | | 1.90 | V |
| POWER SUPPLY CURRENTS | | | | | | | | | | |
| I_{AVDD33} | 56 | | 60 | 56 | | 60 | 56 | | 60 | mA |
| I_{DVDD33} | 11 | | 15 | 12 | | 16 | 12 | | 16 | mA |
| I_{CVDD18} | 18 | | 22 | 18 | | 22 | 18 | | 22 | mA |
| I_{DVDD18} | 30 | | 34 | 31 | | 35 | 32 | | 36 | mA |
| POWER DISSIPATION | | | | | | | | | | |
| $f_{DAC} = 250$ MSPS, $f_{OUT} = 20$ MHz | 305 | | 350 | 310 | | 355 | 310 | | 355 | mW |
| DAC Outputs Disabled | 120 | | | 125 | | | 125 | | | mW |
| Full Device Power-Down | 3 | | | 3 | | | 3 | | | mW |
| OPERATING TEMPERATURE | -40 | | +85 | -40 | | +85 | -40 | | +85 | °C |

AC SPECIFICATIONS

T_{MIN} to T_{MAX} , $AVDD33 = 3.3$ V, $DVDD33 = 3.3$ V, $DVDD18 = 1.8$ V, $CVDD18 = 1.8$ V, $I_{FS} = 20$ mA, full-scale digital input, maximum sample rate, unless otherwise noted.

Table 3. AD9741, AD9743, and AD9745

| Parameter | AD9741 | | | AD9743 | | | AD9745 | | | Unit |
|--|--------|------|-----|--------|------|-----|--------|------|-----|--------|
| | Min | Typ | Max | Min | Typ | Max | Min | Typ | Max | |
| SPURIOUS FREE DYNAMIC RANGE (SFDR) | | | | | | | | | | |
| $f_{DAC} = 250$ MSPS, $f_{OUT} = 20$ MHz | | 70 | | | 80 | | | 82 | | dBc |
| $f_{DAC} = 250$ MSPS, $f_{OUT} = 70$ MHz | | 70 | | | 70 | | | 70 | | dBc |
| $f_{DAC} = 250$ MSPS, $f_{OUT} = 180$ MHz ¹ | | 64 | | | 64 | | | 66 | | dBc |
| INTERMODULATION DISTORTION (IMD) | | | | | | | | | | |
| $f_{DAC} = 250$ MSPS, $f_{OUT} = 20$ MHz | | 80 | | | 80 | | | 86 | | dBc |
| $f_{DAC} = 250$ MSPS, $f_{OUT} = 70$ MHz | | 80 | | | 80 | | | 80 | | dBc |
| $f_{DAC} = 250$ MSPS, $f_{OUT} = 180$ MHz ¹ | | 72 | | | 72 | | | 74 | | dBc |
| CROSSTALK | | | | | | | | | | |
| $f_{DAC} = 250$ MSPS, $f_{OUT} = 20$ MHz | | 80 | | | 80 | | | 80 | | dBc |
| $f_{DAC} = 250$ MSPS, $f_{OUT} = 70$ MHz | | 80 | | | 80 | | | 80 | | dBc |
| $f_{DAC} = 250$ MSPS, $f_{OUT} = 180$ MHz ¹ | | 80 | | | 80 | | | 80 | | dBc |
| ADJACENT CHANNEL LEAKAGE RATIO (ACLR) SINGLE CARRIER WCDMA | | | | | | | | | | |
| $f_{DAC} = 245.76$ MSPS, $f_{OUT} = 15.36$ MHz | | 54 | | | 66 | | | 76 | | dBc |
| $f_{DAC} = 245.76$ MSPS, $f_{OUT} = 61.44$ MHz | | 54 | | | 66 | | | 76 | | dBc |
| $f_{DAC} = 245.76$ MSPS, $f_{OUT} = 184.32$ MHz ¹ | | 54 | | | 64 | | | 72 | | dBc |
| NOISE SPECTRAL DENSITY (NSD) | | | | | | | | | | |
| $f_{DAC} = 245.76$ MSPS, $f_{OUT} = 15.36$ MHz | | -132 | | | -144 | | | -155 | | dBm/Hz |
| $f_{DAC} = 245.76$ MSPS, $f_{OUT} = 61.44$ MHz | | -132 | | | -144 | | | -155 | | dBm/Hz |
| $f_{DAC} = 245.76$ MSPS, $f_{OUT} = 184.32$ MHz ¹ | | -135 | | | -147 | | | -155 | | dBm/Hz |

¹ Mix Mode.

T_{MIN} to T_{MAX}, AVDD33 = 3.3 V, DVDD33 = 3.3 V, DVDD18 = 1.8 V, CVDD18 = 1.8 V, I_{FS} = 20 mA, full-scale digital input, maximum sample rate, unless otherwise noted. The AD9745 is repeated in Table 4 so the user can compare it with all other parts.

Table 4. AD9745, AD9746, and AD9747

| Parameter | AD9745 | | | AD9746 | | | AD9747 | | | Unit |
|--|--------|------|-----|--------|------|-----|--------|------|-----|--------|
| | Min | Typ | Max | Min | Typ | Max | Min | Typ | Max | |
| SPURIOUS FREE DYNAMIC RANGE (SFDR) | | | | | | | | | | |
| f _{DAC} = 250 MSPS, f _{OUT} = 20 MHz | | 82 | | | 82 | | | 82 | | dBc |
| f _{DAC} = 250 MSPS, f _{OUT} = 70 MHz | | 70 | | | 70 | | | 70 | | dBc |
| f _{DAC} = 250 MSPS, f _{OUT} = 180 MHz ¹ | | 66 | | | 66 | | | 66 | | dBc |
| INTERMODULATION DISTORTION (IMD) | | | | | | | | | | |
| f _{DAC} = 250 MSPS, f _{OUT} = 20 MHz | | 86 | | | 86 | | | 86 | | dBc |
| f _{DAC} = 250 MSPS, f _{OUT} = 70 MHz | | 80 | | | 80 | | | 80 | | dBc |
| f _{DAC} = 250 MSPS, f _{OUT} = 180 MHz ¹ | | 74 | | | 74 | | | 74 | | dBc |
| CROSSTALK | | | | | | | | | | |
| f _{DAC} = 250 MSPS, f _{OUT} = 20 MHz | | 80 | | | 80 | | | 80 | | dBc |
| f _{DAC} = 250 MSPS, f _{OUT} = 70 MHz | | 80 | | | 80 | | | 80 | | dBc |
| f _{DAC} = 250 MSPS, f _{OUT} = 180 MHz ¹ | | 80 | | | 80 | | | 80 | | dBc |
| ADJACENT CHANNEL LEAKAGE RATIO (ACLR) SINGLE CARRIER WCDMA | | | | | | | | | | |
| f _{DAC} = 245.76 MSPS, f _{OUT} = 15.36 MHz | | 76 | | | 78 | | | 82 | | dBc |
| f _{DAC} = 245.76 MSPS, f _{OUT} = 61.44 MHz | | 76 | | | 78 | | | 80 | | dBc |
| f _{DAC} = 245.76 MSPS, f _{OUT} = 184.32 MHz ¹ | | 72 | | | 74 | | | 74 | | dBc |
| NOISE SPECTRAL DENSITY (NSD) | | | | | | | | | | |
| f _{DAC} = 245.76 MSPS, f _{OUT} = 15.36 MHz | | -155 | | | -163 | | | -165 | | dBm/Hz |
| f _{DAC} = 245.76 MSPS, f _{OUT} = 61.44 MHz | | -155 | | | -160 | | | -162 | | dBm/Hz |
| f _{DAC} = 245.76 MSPS, f _{OUT} = 184.32 MHz ¹ | | -155 | | | -158 | | | -160 | | dBm/Hz |

¹ Mix Mode.

DIGITAL AND TIMING SPECIFICATIONS

T_{MIN} to T_{MAX} , $AVDD33 = 3.3$ V, $DVDD33 = 3.3$ V, $DVDD18 = 1.8$ V, $CVDD18 = 1.8$ V, $I_{FS} = 20$ mA, full-scale digital input, maximum sample rate, unless otherwise noted.

Table 5. AD9741/AD9743/AD9745/AD9746/AD9747

| Parameter | Min | Typ | Max | Unit |
|---|------|------|------|---------|
| DAC CLOCK INPUTS (CLKP, CLKN) | | | | |
| Differential Peak-to-Peak Voltage | 400 | 800 | 1600 | mV |
| Single-Ended Peak-to-Peak Voltage | | | 800 | mV |
| Common-Mode Voltage | 300 | 400 | 500 | mV |
| Input Current | | | 1 | μ A |
| Input Frequency | | | 250 | MHz |
| DATA CLOCK OUTPUT (DCO) | | | | |
| Output Voltage High | 2.4 | | | V |
| Output Voltage Low | | | 0.4 | V |
| Output Current | | | 10 | mA |
| DAC Clock to Data Clock Output Delay (t_{DCO}) | 2.0 | 2.2 | 2.8 | ns |
| DATA PORT INPUTS | | | | |
| Input Voltage High | 2.0 | | | V |
| Input Voltage Low | | | 0.8 | V |
| Input Current | | | 1 | μ A |
| Data to DAC Clock Setup Time (t_{DBS} Dual-Port Mode) | 400 | | | ps |
| Data to DAC Clock Hold Time (t_{DBH} Dual-Port Mode) | 1200 | | | ps |
| DAC Clock to Analog Output Data Latency (Dual-Port Mode) | | | 7 | Cycles |
| Data or IQSEL Input to DAC Clock Setup Time (t_{DBS} Single-Port Mode) | 400 | | | ps |
| Data or IQSEL Input to DAC Clock Hold Time (t_{DBH} Single-Port Mode) | 1200 | | | ps |
| DAC Clock to Analog Output Data Latency (Single-Port Mode) | | | 8 | Cycles |
| SERIAL PERIPHERAL INTERFACE | | | | |
| SCLK Frequency (f_{SCLK}) | | | 40 | MHz |
| SCLK Pulse Width High (t_{PWH}) | 10 | | | ns |
| SCLK Pulse Width Low (t_{PWL}) | 10 | | | ns |
| CSB to SCLK Setup Time (t_s) | 1 | | | ns |
| CSB to SCLK Hold Time (t_H) | 0 | | | ns |
| SDIO to SCLK Setup Time (t_{DS}) | 1 | | | ns |
| SDIO to SCLK Hold Time (t_{DH}) | 0 | | | ns |
| SCLK to SDIO/SDO Data Valid Time (t_{DV}) | | | 1 | ns |
| RESET Pulse Width High | 10 | | | ns |
| WAKE-UP TIME AND OUTPUT LATENCY | | | | |
| From DAC Outputs Disabled | | 200 | | μ s |
| From Full Device Power-Down | | 1200 | | μ s |
| DAC Clock to Analog Output Latency (Dual-Port Mode) | | 7 | | Cycles |
| DAC Clock to Analog Output Latency (Single-Port Mode) | | 8 | | Cycles |

ABSOLUTE MAXIMUM RATINGS

Table 6.

| Parameter | With Respect to | Rating |
|--|-------------------|--------------------------|
| AVDD33, DVDD33 | AVSS DVSS CVSS | -0.3 V to +3.6 V |
| DVDD18, CVDD18 | AVSS DVSS CVSS | -0.3 V to +1.98 V |
| AVSS | DVSS CVSS | -0.3 V to +0.3 V |
| DVSS | AVSS CVSS | -0.3 V to +0.3 V |
| CVSS | AVSS DVSS | -0.3 V to +0.3 V |
| REFIO | AVSS | -0.3 V to AVDD33 + 0.3 V |
| IOUT1P, IOUT1N, IOUT2P, IOUT2P, AUX1P, AUX1N, AUX2P, AUX2N | AVSS | -1.0 V to AVDD33 + 0.3 V |
| P1D15 to P1D0, P2D15 to P2D0 | DVSS | -0.3 V to DVDD33 + 0.3 V |
| CLKP, CLKN | CVSS | -0.3 V to CVDD18 + 0.3 V |
| RESET, CSB, SCLK, SDIO, SDO | DVSS | -0.3 V to DVDD33 + 0.3 V |
| Junction Temperature | | 125°C |
| Storage Temperature | | -65°C to +150°C |

THERMAL RESISTANCE

Thermal resistance tested using JEDEC standard 4-layer thermal test board with no airflow.

Table 7.

| Package Type | θ_{JA} | Unit |
|---------------------------------------|---------------|------|
| CP-72-1 (Exposed Pad Soldered to PCB) | 25 | °C/W |

Stresses above those listed under Absolute Maximum Ratings may cause permanent damage to the device. This is a stress rating only; functional operation of the device at these or any other conditions above those indicated in the operational section of this specification is not implied. Exposure to absolute maximum rating conditions for extended periods may affect device reliability.

ESD CAUTION



ESD (electrostatic discharge) sensitive device.

Charged devices and circuit boards can discharge without detection. Although this product features patented or proprietary protection circuitry, damage may occur on devices subjected to high energy ESD. Therefore, proper ESD precautions should be taken to avoid performance degradation or loss of functionality.

PIN CONFIGURATIONS AND FUNCTION DESCRIPTIONS

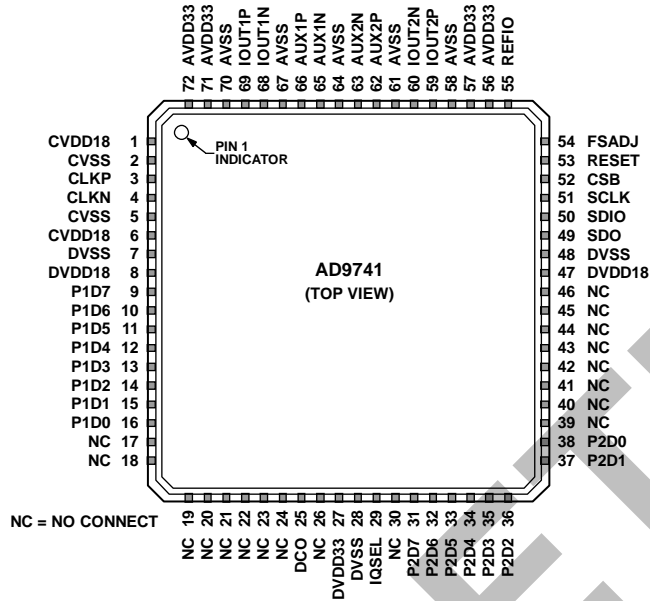

Figure 2. AD9741 Pin Configuration

Table 8. AD9741 Pin Function Descriptions

| Pin No. | Mnemonic | Description |
|----------------------------|----------|---|
| 1, 6 | CVDD18 | Clock Supply Voltage (1.8 V). |
| 2, 5 | CVSS | Clock Supply Common (0 V). |
| 3 | CLKP | Differential DAC Clock Input. |
| 4 | CLKN | Complementary Differential DAC Clock Input. |
| 7, 28, 48 | DVSS | Digital Supply Common (0V). |
| 8, 47 | DVDD18 | Digital Core Supply Voltage (1.8 V). |
| 9 to 16 | P1D<7:0> | Port 1 Data Bit Inputs. |
| 17 to 24, 26, 30, 39 to 46 | NC | No Connect. |
| 25 | DCO | Data Clock Output. Use to clock data source. |
| 27 | DVDD33 | Digital I/O Supply Voltage (3.3 V). |
| 29 | IQSEL | I/Q Framing Signal for Single-Port Mode Operation. |
| 31 to 38 | P2D<7:0> | Port 2 Data Bit Inputs. |
| 49 | SDO | Serial Peripheral Interface Data Output. |
| 50 | SDIO | Serial Peripheral Interface Data Input and Optional Data Output. |
| 51 | SCLK | Serial Peripheral Interface Clock Input. |
| 52 | CSB | Serial Peripheral Interface Chip Select Input. Active low. |
| 53 | RESET | Hardware Reset. Active high. |
| 54 | FSADJ | Full-Scale Current Output Adjust. Connect a 10 kΩ resistor to AVSS. |
| 55 | REFIO | Reference Input/Output. Connect a 0.1 μF capacitor to AVSS. |
| 56, 57, 71, 72 | AVDD33 | Analog Supply Voltage (3.3 V). |
| 58, 61, 64, 67, 70 | AVSS | Analog Supply Common (0 V). |
| 59 | IOUT2P | DAC2 Current Output True. Sources full-scale current when input data bits are all 1. |
| 60 | IOUT2N | DAC2 Current Output Complement. Sources full-scale current when data bits are all 0. |
| 62 | AUX2P | Auxiliary DAC2 Default Current Output Pin. |
| 63 | AUX2N | Auxiliary DAC2 Optional Output Pin. Enable through SPI. |
| 65 | AUX1N | Auxiliary DAC1 Optional Output Pin. Enable through SPI. |
| 66 | AUX1P | Auxiliary DAC1 Default Current Output Pin. |
| 68 | IOUT1N | Complementary DAC1 Current Output. Sources full-scale current when data bits are all 0. |
| 69 | IOUT1P | DAC1 Current Output. Sources full-scale current when data bits are all 1. |
| EPAD | AVSS | Exposed Thermal Pad. Must be soldered to copper pour on top surface of PCB for mechanical stability and must be electrically tied to low impedance GND plane for low noise performance. |

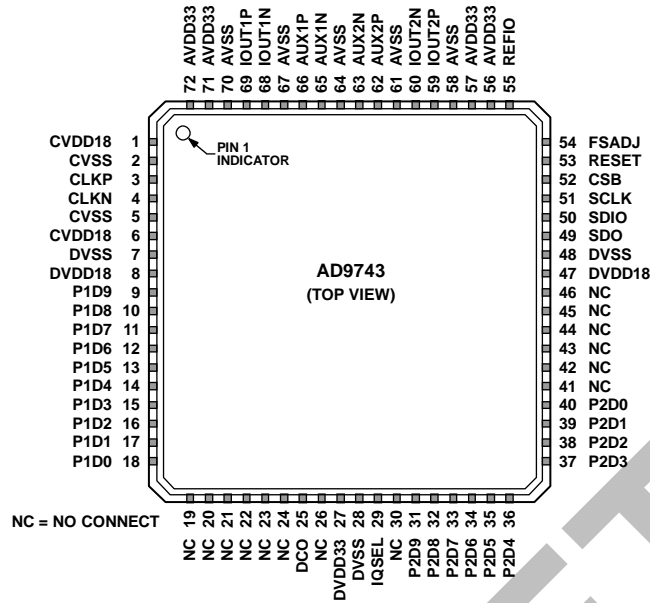

Figure 3. AD9743 Pin Configuration

Table 9. AD9743 Pin Function Descriptions

| Pin No. | Mnemonic | Description |
|----------------------------|----------|---|
| 1, 6 | CVDD18 | Clock Supply Voltage (1.8 V). |
| 2, 5 | CVSS | Clock Supply Common (0 V). |
| 3 | CLKP | Differential DAC Clock Input. |
| 4 | CLKN | Complementary Differential DAC Clock Input. |
| 7, 28, 48 | DVSS | Digital Supply Common (0 V). |
| 8, 47 | DVDD18 | Digital Core Supply Voltage (1.8 V). |
| 9 to 18 | P1D<9:0> | Port 1 Data Bit Inputs. |
| 19 to 24, 26, 30, 41 to 46 | NC | No Connect. |
| 25 | DCO | Data Clock Output. Use to clock data source. |
| 27 | DVDD33 | Digital I/O Supply Voltage (3.3 V). |
| 29 | IQSEL | I/Q Framing Signal for Single-Port Mode Operation. |
| 31 to 40 | P2D<9:0> | Port 2 Data Bit Inputs. |
| 49 | SDO | Serial Peripheral Interface Data Output. |
| 50 | SDIO | Serial Peripheral Interface Data Input and Optional Data Output. |
| 51 | SCLK | Serial Peripheral Interface Clock Input. |
| 52 | CSB | Serial Peripheral Interface Chip Select Input. Active low. |
| 53 | RESET | Hardware Reset. Active high. |
| 54 | FSADJ | Full-Scale Current Output Adjust. Connect a 10 kΩ resistor to AVSS. |
| 55 | REFIO | Reference Input/Output. Connect a 0.1 μF capacitor to AVSS. |
| 56, 57, 71, 72 | AVDD33 | Analog Supply Voltage (3.3 V). |
| 58, 61, 64, 67, 70 | AVSS | Analog Supply Common (0 V). |
| 59 | IOOUT2P | DAC2 Current Output True. Sources full-scale current when input data bits are all 1. |
| 60 | IOOUT2N | DAC2 Current Output Complement. Sources full-scale current when data bits are all 0. |
| 62 | AUX2P | Auxiliary DAC2 Default Current Output Pin. |
| 63 | AUX2N | Auxiliary DAC2 Optional Output Pin. Enable through SPI. |
| 65 | AUX1N | Auxiliary DAC1 Optional Output Pin. Enable through SPI. |
| 66 | AUX1P | Auxiliary DAC1 Default Current Output Pin. |
| 68 | IOOUT1N | Complementary DAC1 Current Output. Sources full-scale current when data bits are all 0. |
| 69 | IOOUT1P | DAC1 Current Output. Sources full-scale current when data bits are all 1. |
| EPAD | AVSS | Exposed Thermal Pad. Must be soldered to copper pour on top surface of PCB for mechanical stability and must be electrically tied to low impedance GND plane for low noise performance. |

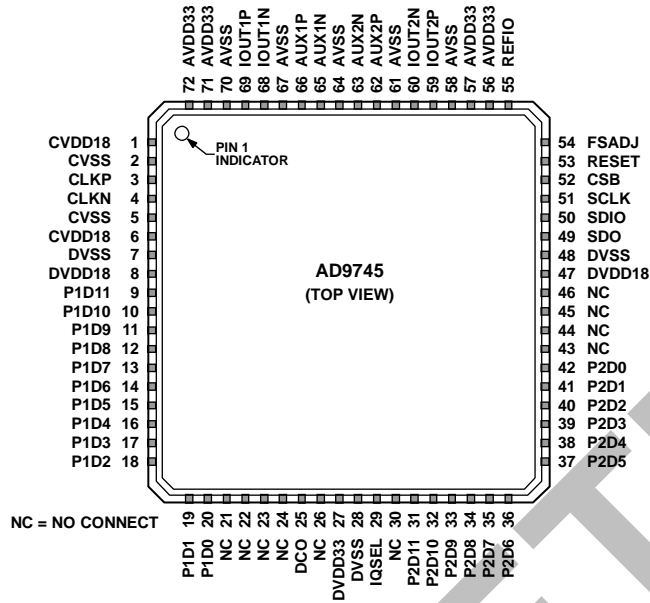

Figure 4. AD9745 Pin Configuration

Table 10. AD9745 Pin Function Descriptions

| Pin No. | Mnemonic | Description |
|----------------------------|-----------|---|
| 1, 6 | CVDD18 | Clock Supply Voltage (1.8 V). |
| 2, 5 | CVSS | Clock Supply Common (0 V). |
| 3 | CLKP | Differential DAC Clock Input. |
| 4 | CLKN | Complementary Differential DAC Clock Input. |
| 7, 28, 48 | DVSS | Digital Supply Common (0 V). |
| 8, 47 | DVDD18 | Digital Core Supply Voltage (1.8 V). |
| 9 to 20 | P1D<11:0> | Port 1 Data Bit Inputs. |
| 21 to 24, 26, 30, 43 to 46 | NC | No Connect. |
| 25 | DCO | Data Clock Output. Use to clock data source. |
| 27 | DVDD33 | Digital I/O Supply Voltage (3.3 V). |
| 29 | IQSEL | I/Q Framing Signal for Single-Port Mode Operation. |
| 31 to 42 | P2D<11:0> | Port 2 Data Bit Inputs. |
| 49 | SDO | Serial Peripheral Interface Data Output. |
| 50 | SDIO | Serial Peripheral Interface Data Input and Optional Data Output. |
| 51 | SCLK | Serial Peripheral Interface Clock Input. |
| 52 | CSB | Serial Peripheral Interface Chip Select Input. Active low. |
| 53 | RESET | Hardware Reset. Active high. |
| 54 | FSADJ | Full-Scale Current Output Adjust. Connect 10 kΩ resistor to AVSS. |
| 55 | REFIO | Reference Input/Output. Connect a 0.1 μF capacitor to AVSS. |
| 56, 57, 71, 72 | AVDD33 | Analog Supply Voltage (3.3 V). |
| 58, 61, 64, 67, 70 | AVSS | Analog Supply Common (0 V). |
| 59 | IOUT2P | DAC2 Current Output True. Sources full-scale current when input data bits are all 1. |
| 60 | IOUT2N | DAC2 Current Output Complement. Sources full-scale current when data bits are all 0. |
| 62 | AUX2P | Auxiliary DAC2 Default Current Output Pin. |
| 63 | AUX2N | Auxiliary DAC2 Optional Output Pin. Enable through SPI. |
| 65 | AUX1N | Auxiliary DAC1 Optional Output Pin. Enable through SPI. |
| 66 | AUX1P | Auxiliary DAC1 Default Current Output Pin. |
| 68 | IOUT1N | Complementary DAC1 Current Output. Sources full-scale current when data bits are all 0. |
| 69 | IOUT1P | DAC1 Current Output. Sources full-scale current when data bits are all 1. |
| EPAD | AVSS | Exposed Thermal Pad. Must be soldered to copper pour on top surface of PCB for mechanical stability and must be electrically tied to low impedance GND plane for low noise performance. |

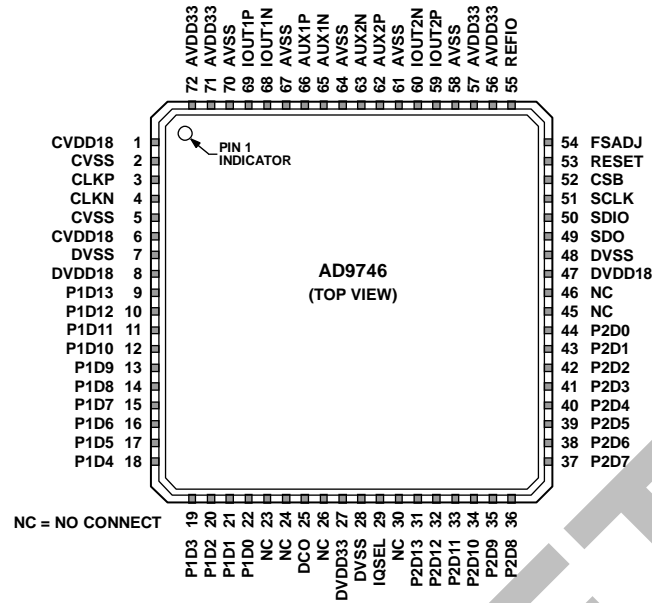

Figure 5. AD9746 Pin Configuration

Table 11. AD9746 Pin Function Descriptions

| Pin No. | Mnemonic | Description |
|------------------------|-----------|---|
| 1, 6 | CVDD18 | Clock Supply Voltage (1.8 V). |
| 2, 5 | CVSS | Clock Supply Common (0 V). |
| 3 | CLKP | Differential DAC Clock Input. |
| 4 | CLKN | Complementary Differential DAC Clock Input. |
| 7, 28, 48 | DVSS | Digital Supply Common (0 V). |
| 8, 47 | DVDD18 | Digital Core Supply Voltage (1.8 V). |
| 9 to 22 | P1D<13:0> | Port 1 Data Bit Inputs. |
| 23, 24, 26, 30, 45, 46 | NC | No Connect. |
| 25 | DCO | Data Clock Output. Use to clock data source. |
| 27 | DVDD33 | Digital I/O Supply Voltage (3.3 V). |
| 29 | IQSEL | I/Q Framing Signal for Single-Port Mode Operation. |
| 31 to 44 | P2D<13:0> | Port 2 Data Bit Inputs. |
| 49 | SDO | Serial Peripheral Interface Data Output. |
| 50 | SDIO | Serial Peripheral Interface Data Input and Optional Data Output. |
| 51 | SCLK | Serial Peripheral Interface Clock Input. |
| 52 | CSB | Serial Peripheral Interface Chip Select Input. Active low. |
| 53 | RESET | Hardware Reset. Active high. |
| 54 | FSADJ | Full-Scale Current Output Adjust. Connect a 10 kΩ resistor to AVSS. |
| 55 | REFIO | Reference Input/Output. Connect a 0.1 μF capacitor to AVSS. |
| 56, 57, 71, 72 | AVDD33 | Analog Supply Voltage (3.3 V). |
| 58, 61, 64, 67, 70 | AVSS | Analog Supply Common (0 V). |
| 59 | IOUT2P | DAC2 Current Output True. Sources full-scale current when input data bits are all 1. |
| 60 | IOUT2N | DAC2 Current Output Complement. Sources full-scale current when data bits are all 0. |
| 62 | AUX2P | Auxiliary DAC2 Default Current Output Pin. |
| 63 | AUX2N | Auxiliary DAC2 Optional Output Pin. Enable through SPI. |
| 65 | AUX1N | Auxiliary DAC1 Optional Output Pin. Enable through SPI. |
| 66 | AUX1P | Auxiliary DAC1 Default Current Output Pin. |
| 68 | IOUT1N | Complementary DAC1 Current Output. Sources full-scale current when data bits are all 0. |
| 69 | IOUT1P | DAC1 Current Output. Sources full-scale current when data bits are all 1. |
| EPAD | AVSS | Exposed Thermal Pad. Must be soldered to copper pour on top surface of PCB for mechanical stability and must be electrically tied to low impedance GND plane for low noise performance. |

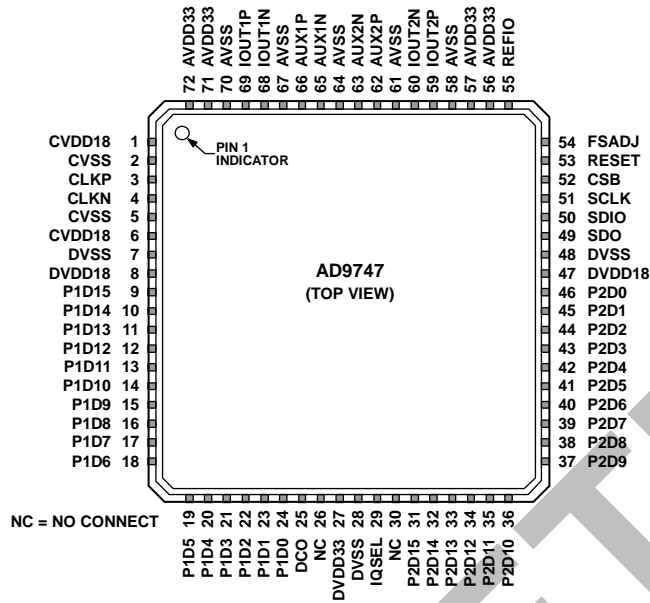

Figure 6. AD9747 Pin Configuration

Table 12. AD9747 Pin Function Descriptions

| Pin No. | Mnemonic | Description |
|--------------------|-----------|---|
| 1, 6 | CVDD18 | Clock Supply Voltage (1.8 V). |
| 2, 5 | CVSS | Clock Supply Common (0 V). |
| 3 | CLKP | Differential DAC Clock Input. |
| 4 | CLKN | Complementary Differential DAC Clock Input. |
| 7, 28, 48 | DVSS | Digital Supply Common (0 V). |
| 8, 47 | DVDD18 | Digital Core Supply Voltage (1.8 V). |
| 9 to 24 | P1D<15:0> | Port 1 Data Bit Inputs. |
| 25 | DCO | Data Clock Output. Use to clock data source. |
| 26, 30 | NC | No Connect. |
| 27 | DVDD33 | Digital I/O Supply Voltage (3.3 V). |
| 29 | IQSEL | I/Q Framing Signal for Single-Port Mode Operation. |
| 31 to 46 | P2D<15:0> | Port 2 Data Bit Inputs. |
| 49 | SDO | Serial Peripheral Interface Data Output. |
| 50 | SDIO | Serial Peripheral Interface Data Input and Optional Data Output. |
| 51 | SCLK | Serial Peripheral Interface Clock Input. |
| 52 | CSB | Serial Peripheral Interface Chip Select Input. Active low. |
| 53 | RESET | Hardware Reset. Active high. |
| 54 | FSADJ | Full-Scale Current Output Adjust. Connect a 10 kΩ resistor to AVSS. |
| 55 | REFIO | Reference Input/Output. Connect a 0.1 μF capacitor to AVSS. |
| 56, 57, 71, 72 | AVDD33 | Analog Supply Voltage (3.3 V). |
| 58, 61, 64, 67, 70 | AVSS | Analog Supply Common (0 V). |
| 59 | IOUT2P | DAC2 Current Output. Sources full-scale current when input data bits are all 1. |
| 60 | IOUT2N | Complementary DAC2 Current Output. Sources full-scale current when data bits are all 0. |
| 62 | AUX2P | Auxiliary DAC2 Default Current Output Pin. |
| 63 | AUX2N | Auxiliary DAC2 Optional Output Pin. Enable through SPI. |
| 65 | AUX1N | Auxiliary DAC1 Optional Output Pin. Enable through SPI. |
| 66 | AUX1P | Auxiliary DAC1 Default Current Output Pin. |
| 68 | IOUT1N | Complementary DAC1 Current Output. Sources full-scale current when data bits are all 0. |
| 69 | IOUT1P | DAC1 Current Output. Sources full-scale current when data bits are all 1. |
| EPAD | AVSS | Exposed Thermal Pad. Must be soldered to copper pour on top surface of PCB for mechanical stability and must be electrically tied to low impedance GND plane for low noise performance. |

TYPICAL PERFORMANCE CHARACTERISTICS

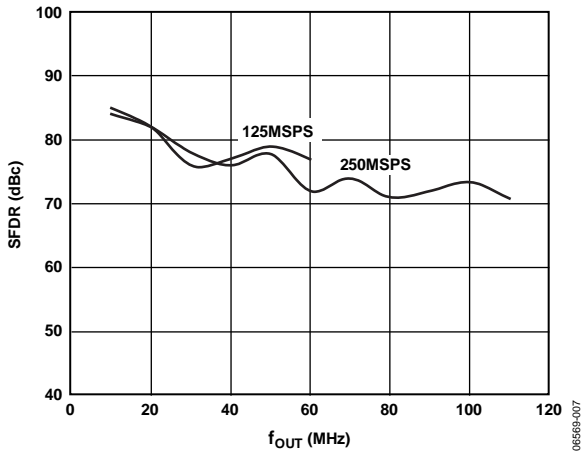

Figure 7. AD9747 SFDR vs. f_{OUT} , Normal Mode

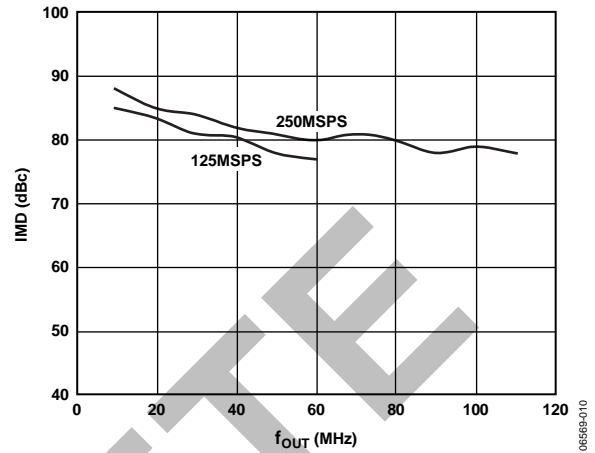

Figure 10. AD9747 IMD vs. f_{OUT} , Normal Mode

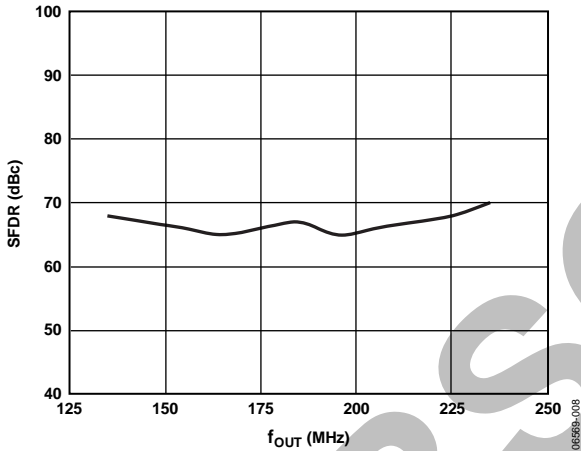

Figure 8. AD9747 SFDR vs. f_{OUT} , Mix Mode, 250 MSPS

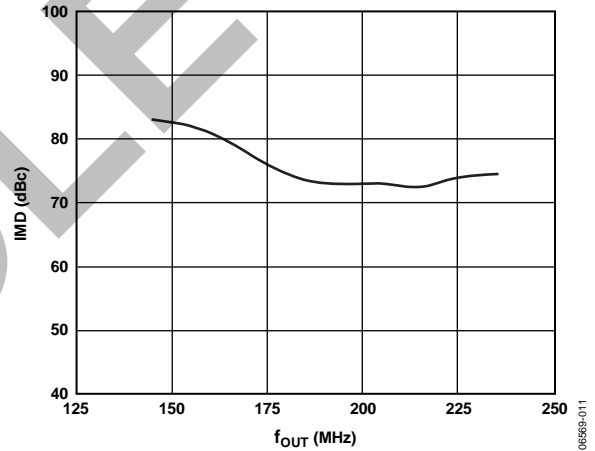

Figure 11. AD9747 IMD vs. f_{OUT} , Mix Mode, 250 MSPS

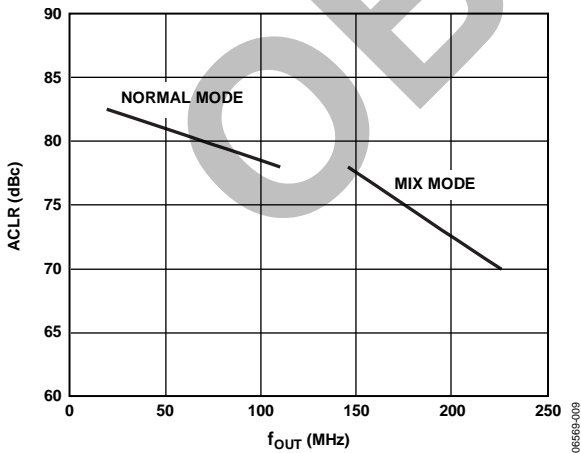

Figure 9. AD9747 ACLR vs. f_{OUT} , Single Carrier WCDMA, 245.76 MSPS

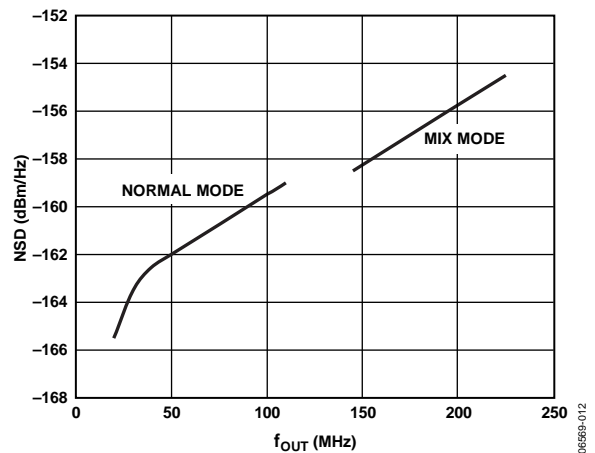

Figure 12. AD9747 NSD vs. f_{OUT} , Single Carrier WCDMA, 245.76 MSPS

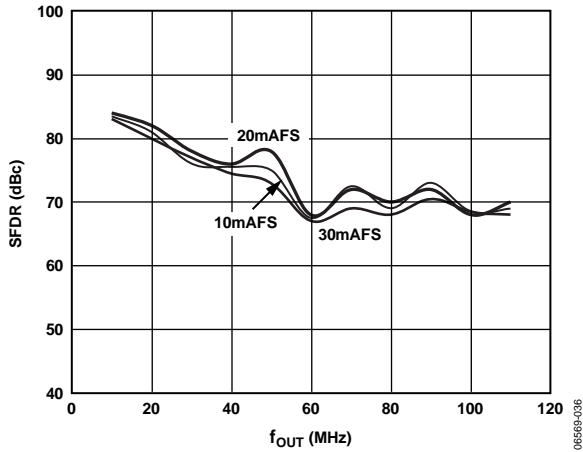

Figure 13. AD9747 SFDR vs. Analog Output, 250 MSPS

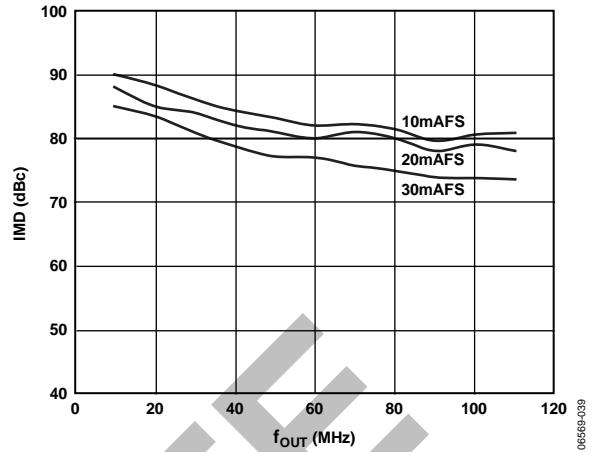

Figure 16. AD9747 IMD vs. Analog Output, 250 MSPS

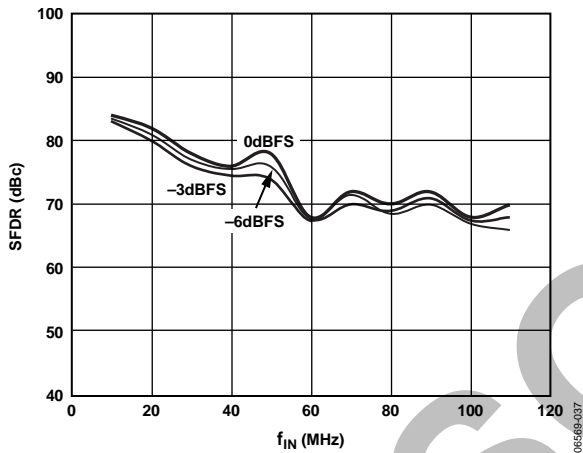

Figure 14. AD9747 SFDR vs. Digital Input, 250 MSPS

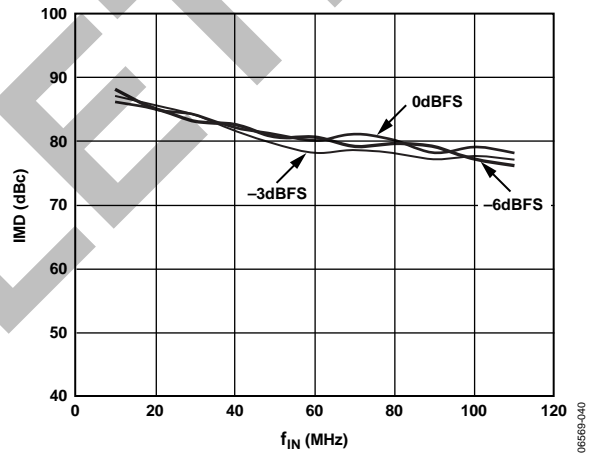

Figure 17. AD9747 IMD vs. Digital Input, 250 MSPS

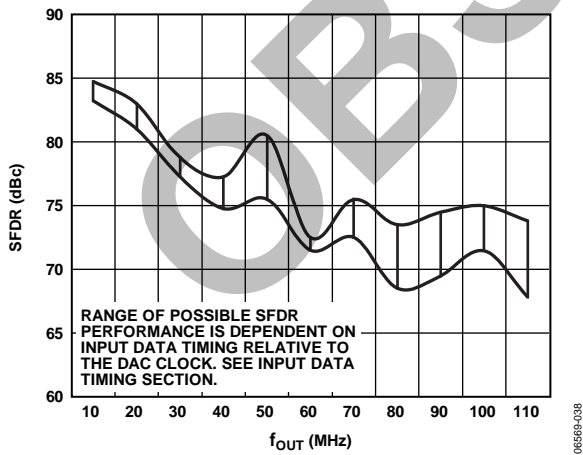

Figure 15. AD9747 SFDR vs. f_{OUT} Over Input Data Timing

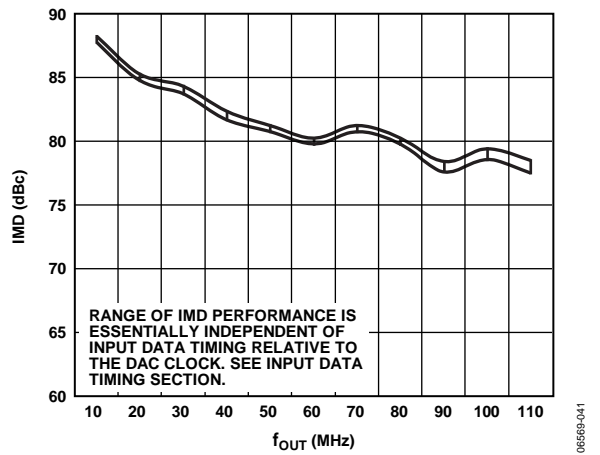

Figure 18. AD9747 IMD vs. f_{OUT} Over Input Data Timing

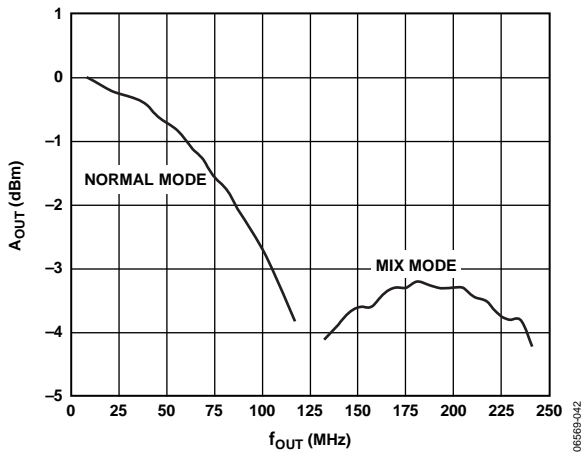

Figure 19. Nominal Power in the Fundamental, $I_{FS} = 20\text{ mA}$

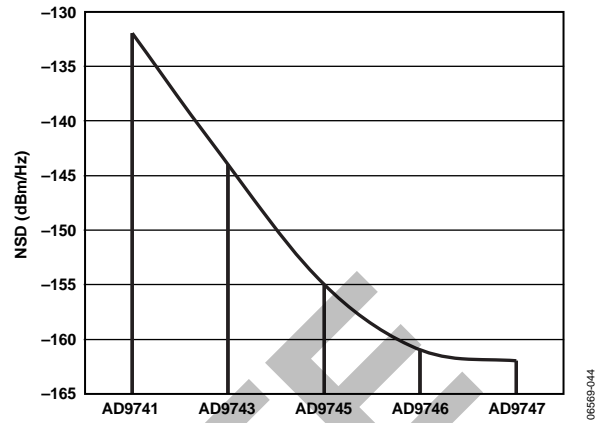

Figure 21. NSD vs. Bit Resolution, Single Carrier WCDMA, 245.76 MSPS, $f_{CARRIER} = 61.44\text{ MHz}$

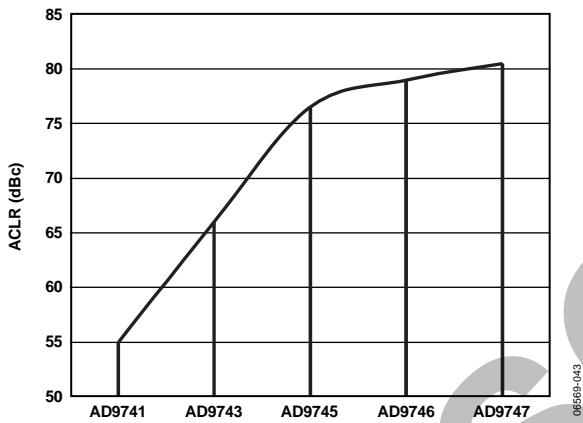

Figure 20. ACLR vs. Bit Resolution, Single Carrier WCDMA, 245.76 MSPS, $f_{CARRIER} = 61.44\text{ MHz}$

TERMINOLOGY

Integral Nonlinearity (INL)

The maximum deviation of the actual analog output from the ideal output, as determined by a straight line drawn from zero scale to full scale.

Differential Nonlinearity (DNL)

A measure of the maximum deviation in analog output associated with any single value change in the digital input code relative to an ideal LSB.

Monotonicity

A DAC is monotonic if the analog output increases or remains constant in response to an increase in the digital input.

Offset Error

The deviation of the output current from the ideal zero-scale current. For differential outputs, 0 mA is expected at I_{OUTP} when all inputs are low, and 0 mA is expected at I_{OUTN} when all inputs are high.

Gain Error

The deviation of the output current from the ideal full-scale current. Actual full-scale output current is determined by subtracting the output (when all inputs are low) from the output (when all inputs are high).

Output Compliance Range

The range of allowable voltage seen by the analog output of a current output DAC. Operation beyond the compliance limits may cause output stage saturation and/or a breakdown resulting in nonlinear performance.

Temperature Drift

Temperature drift is specified as the maximum change in a parameter from ambient temperature (25°C) to either T_{MIN} or T_{MAX} and is typically reported as ppm/°C.

Spurious-Free Dynamic Range (SFDR)

The difference in decibels between the peak amplitude of a test tone and the peak amplitude of the largest spurious signal over the specified bandwidth.

Intermodulation Distortion (IMD)

The difference in decibels between the maximum peak amplitude of two test tones and the maximum peak amplitude of the distortion products created from the sum or difference of integer multiples of the test tones.

Adjacent Channel Leakage Ratio (ACLR)

The ratio between the measured power of a wideband signal within a channel relative to the measured power in an empty adjacent channel.

Noise Spectral Density (NSD)

The measured noise power over a 1 Hz bandwidth seen at the analog output.

THEORY OF OPERATION

The AD9741/AD9743/AD9745/AD9746/AD9747 combine many features to make them very attractive for wired and wireless communications systems. The dual DAC architecture facilitates easy interfacing to common quadrature modulators when designing single sideband transmitters. In addition, the speed and performance of the devices allow wider bandwidths and more carriers to be synthesized than in previously available products.

All features and options are software programmable through the SPI port.

SERIAL PERIPHERAL INTERFACE

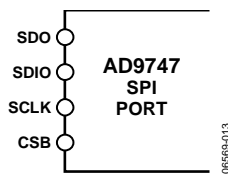

Figure 22. SPI Port

The SPI port is a flexible, synchronous serial communications port allowing easy interfacing to many industry-standard microcontrollers and microprocessors. The port is compatible with most synchronous transfer formats including both the Motorola SPI and Intel® SSR protocols.

The interface allows read and write access to all registers that configure the AD9741/AD9743/AD9745/AD9746/AD9747. Single or multiple byte transfers are supported as well as MSB-first or LSB-first transfer formats. Serial data input/output can be accomplished through a single bidirectional pin (SDIO) or through two unidirectional pins (SDIO/SDO).

The serial port configuration is controlled by Register 0x00, Bits<7:6>. It is important to note that any change made to the serial port configuration occurs immediately upon writing to the last bit of this byte. Therefore, it is possible with a multibyte transfer to write to this register and change the configuration in the middle of a communication cycle. Care must be taken to compensate for the new configuration within the remaining bytes of the current communication cycle.

Use of a single-byte transfer when changing the serial port configuration is recommended to prevent unexpected device behavior.

GENERAL OPERATION OF THE SERIAL INTERFACE

There are two phases to any communication cycle with the AD9741/AD9743/AD9745/AD9746/AD9747: Phase 1 and Phase 2. Phase 1 is the instruction cycle, which writes an instruction byte into the device. This byte provides the serial port controller with information regarding Phase 2 of the communication cycle: the data transfer cycle.

The Phase 1 instruction byte defines whether the upcoming data transfer is read or write, the number of bytes in the data

transfer, and a reference register address for the first byte of the data transfer. A logic high on the CSB pin followed by a logic low resets the SPI port to its initial state and defines the start of the instruction cycle. From this point, the next eight rising SCLK edges define the eight bits of the instruction byte for the current communication cycle.

The remaining SCLK edges are for Phase 2 of the communication cycle, which is the data transfer between the serial port controller and the system controller. Phase 2 can be a transfer of 1, 2, 3, or 4 data bytes as determined by the instruction byte. Using multibyte transfers is usually preferred although single-byte data transfers are useful to reduce CPU overhead or when only a single register access is required.

All serial port data is transferred to and from the device in synchronization with the SCLK pin. Input data is always latched on the rising edge of SCLK whereas output data is always valid after the falling edge of SCLK. Register contents change immediately upon writing to the last bit of each transfer byte.

When synchronization is lost, the device has the ability to asynchronously terminate an I/O operation whenever the CSB pin is taken to logic high. Any unwritten register content data is lost if the I/O operation is aborted. Taking CSB low then resets the serial port controller and restarts the communication cycle.

INSTRUCTION BYTE

The instruction byte contains the information shown in the following bit map.

| MSB | | | | | | LSB | |
|-----|----|----|----|----|----|-----|----|
| B7 | B6 | B5 | B4 | B3 | B2 | B1 | B0 |
| R/W | N1 | N0 | A4 | A3 | A2 | A1 | A0 |

Bit 7, R/W, determines whether a read or a write data transfer occurs after the instruction byte write. Logic high indicates a read operation. Logic 0 indicates a write operation.

Bits<6:5>, N1 and N0, determine the number of bytes to be transferred during the data transfer cycle. The bits decode as shown in Table 13.

Table 13. Byte Transfer Count

| N1 | N0 | Description |
|----|----|----------------------|
| 0 | 0 | Transfer one byte |
| 0 | 1 | Transfer two bytes |
| 1 | 0 | Transfer three bytes |
| 1 | 1 | Transfer four bytes |

Bits<4:0>, A4, A3, A2, A1, and A0, determine which register is accessed during the data transfer of the communications cycle. For multibyte transfers, this address is a starting or ending address depending on the current data transfer mode. For MSB-first format, the specified address is an ending address or the most significant address in the current cycle. Remaining register addresses for multiple byte data transfers are generated

internally by the serial port controller by decrementing from the specified address. For LSB-first format, the specified address is a beginning address or the least significant address in the current cycle. Remaining register addresses for multiple byte data transfers are generated internally by the serial port controller by incrementing from the specified address.

MSB/LSB TRANSFERS

The serial port can support both MSB-first and LSB-first data formats. This functionality is controlled by Register 0x00, Bit 6. The default is Logic 0, which is MSB-first format.

When using MSB-first format (LSBFIRST = 0), the instruction and data bit must be written from MSB to LSB. Multibyte data transfers in MSB-first format start with an instruction byte that includes the register address of the most significant data byte. Subsequent data bytes are loaded into sequentially lower address locations. In MSB-first mode, the serial port internal address generator decrements for each byte of the multibyte data transfer.

When using LSB-first format (LSBFIRST = 1), the instruction and data bit must be written from LSB to MSB. Multibyte data transfers in LSB-first format start with an instruction byte that includes the register address of the least significant data byte. Subsequent data bytes are loaded into sequentially higher address locations. In LSB-first mode, the serial port internal address generator increments for each byte of the multibyte data transfer.

Use of a single-byte transfer when changing the serial port data format is recommended to prevent unexpected device behavior.

SERIAL INTERFACE PORT PIN DESCRIPTIONS

Chip Select Bar (CSB)

Active low input starts and gates a communication cycle. It allows more than one device to be used on the same serial communication lines. CSB must stay low during the entire communication cycle. Incomplete data transfers are aborted anytime the CSB pin goes high. SDO and SDIO pins go to a high impedance state when this input is high.

Serial Clock (SCLK)

The serial clock pin is used to synchronize data to and from the device and to run the internal state machines. The maximum frequency of SCLK is 40 MHz. All data input is registered on the rising edge of SCLK. All data is driven out on the falling edge of SCLK.

Serial Data I/O (SDIO)

Data is always written into the device on this pin. However, SDIO can also function as a bidirectional data output line.

The configuration of this pin is controlled by Register 0x00, Bit 7. The default is Logic 0, which configures the SDIO pin as unidirectional.

Serial Data Out (SDO)

Data is read from this pin for protocols that use separate lines for transmitting and receiving data. The configuration of this pin is controlled by Register 0x00, Bit 7. If this bit is set to a Logic 1, the SDO pin does not output data and is set to a high impedance state.

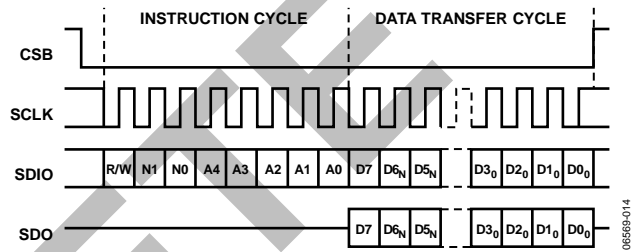

Figure 23. Serial Register Interface—MSB First

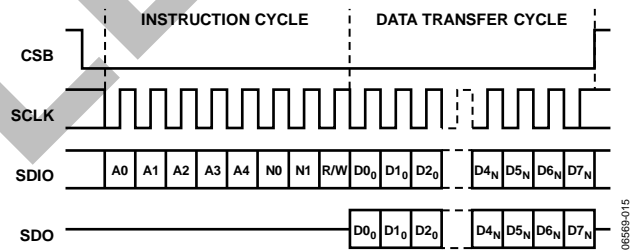

Figure 24. Serial Register Interface Timing—LSB First

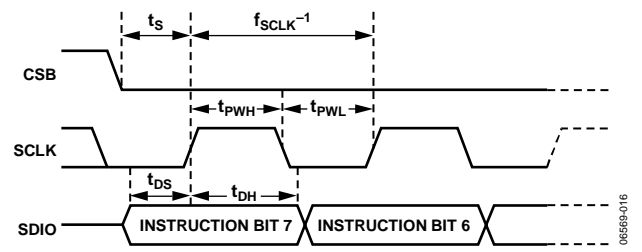

Figure 25. Timing Diagram for SPI Register Write

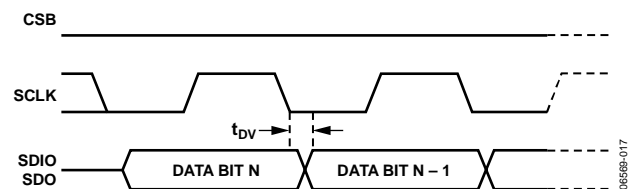

Figure 26. Timing Diagram for SPI Register Read

SPI REGISTER MAP

Reading any register returns previously written values for all defined register bits, unless otherwise noted. Change serial port configuration or execute software reset in single byte instruction only to avoid unexpected device behavior.

Table 14.

| Register Name | Address | Default | Bit 7 | Bit 6 | Bit 5 | Bit 4 | Bit 3 | Bit 2 | Bit 1 | Bit 0 |
|-----------------|---------|---------|--------------|----------|---------|---------|--------------|--------|--------------|---------|
| SPI Control | 0x00 | 0x00 | SDIODIR | LSBFIRST | SWRESET | | | | | |
| Data Control | 0x02 | 0x00 | DATYPE | ONEPORT | | INVDCO | | | | |
| Power Down | 0x03 | 0x00 | PD_DCO | | PD_AUX2 | PD_AUX1 | PD_BIAS | PC_CLK | PD_DAC2 | PD_DAC1 |
| DAC Mode Select | 0x0A | 0x00 | | | | | DAC1MOD<1:0> | | DAC2MOD<1:0> | |
| DAC1 Gain LSB | 0x0B | 0xF9 | DAC1FSC<7:0> | | | | | | | |
| DAC1 Gain MSB | 0x0C | 0x01 | | | | | | | DAC1FSC<9:8> | |
| AUX DAC1 LSB | 0x0D | 0x00 | AUXDAC1<7:0> | | | | | | | |
| AUX DAC1 MSB | 0x0E | 0x00 | AUX1PIN | AUX1DIR | | | | | AUXDAC1<9:8> | |
| DAC2 Gain LSB | 0x0F | 0xF9 | DAC2FSC<7:0> | | | | | | | |
| DAC2 Gain MSB | 0x10 | 0x01 | | | | | | | DAC2FSC<9:8> | |
| AUX DAC2 LSB | 0x11 | 0x00 | AUXDAC2<7:0> | | | | | | | |
| AUX DAC2 MSB | 0x12 | 0x00 | AUX2PIN | AUX2DIR | | | | | AUXDAC2<9:8> | |

SPI REGISTER DESCRIPTIONS

Table 15.

| Register | Address | Bit | Name | Description |
|-----------------|---------|-----|--------------|--|
| SPI Control | 0x00 | 7 | SDIODIR | 0, operate SPI in 4-wire mode, SDIO pin operates as an input only 1, operate SPI in 3-wire mode, SDIO pin operates as a bidirectional I/O line |
| | | 6 | LSBFIRST | 0, LSBFIRST off, SPI serial data mode is MSB to LSB 1, LSBFIRST on, SPI serial data mode is LSB to MSB |
| | | 5 | SWRESET | 0, resume normal operation following software RESET 1, software RESET; loads default values to all registers (except Register 0x00) |
| Data Control | 0x02 | 7 | DATTYPE | 0, DAC input data is twos complement binary format 1, DAC input data is unsigned binary format |
| | | 6 | ONEPORT | 0, normal two port input mode 1, optional single port input mode, interleaved data received on Port 1 only |
| | | 4 | INVDCO | 1, inverts data clock output signal |
| Power Down | 0x03 | 7 | PD_DCO | 1, power down data clock output |
| | | 5 | PD_AUX2 | 1, power down AUX2 DAC |
| | | 4 | PD_AUX1 | 1, power down AUX1 DAC |
| | | 3 | PD_BIAS | 1, power down reference voltage bias circuit |
| | | 2 | PD_CLK | 1, power down DAC clock input circuit |
| | | 1 | PD_DAC2 | 1, power down DAC2 analog output |
| | | 0 | PD_DAC1 | 1, power down DAC1 analog output |
| DAC Mode Select | 0x0A | 3:2 | DAC1MOD<1:0> | 00, selects normal mode, DAC1 01, selects mix mode, DAC1 10, selects return-to-zero mode, DAC1 |
| | | 1:0 | DAC2MOD<1:0> | 00, selects normal mode, DAC2 01, selects mix mode, DAC2 10, selects return-to-zero mode, DAC2 |
| DAC1 Gain | 0x0B | 7:0 | DAC1FSC<7:0> | DAC1 full-scale 10-bit adjustment word |
| | 0x0C | 1:0 | DAC1FSC<9:8> | 0x03FF, sets full-scale current to the maximum value of 31.66 mA 0x01F9, sets full-scale current to the nominal value of 20.0 mA 0x0000, sets full-scale current to the minimum value of 8.64 mA |
| AUX DAC1 | 0x0D | 7:0 | AUXDAC1<7:0> | Auxiliary DAC1 10-bit output current adjustment word |
| | | 1:0 | AUXDAC1<9:8> | 0x03FF, sets output current magnitude to 2.0 mA 0x0200, sets output current magnitude to 1.0 mA 0x0000, sets output current magnitude to 0.0 mA |
| | 0x0E | 7 | AUX1PIN | 1, AUX1P output pin is active 0, AUX1N output pin is active |
| | | 6 | AUX1DIR | 0, configures AUX1 DAC output to source current 1, configures AUX1 DAC output to sink current |
| DAC2 Gain | 0x0F | 7:0 | DAC2FSC<7:0> | DAC2 full-scale 10-bit adjustment word |
| | 0x10 | 1:0 | DAC2FSC<9:8> | 0x03FF, sets full-scale current to the maximum value of 31.66 mA 0x01F9, sets full-scale current to the nominal value of 20.0 mA 0x0000, sets full-scale current to the minimum value of 8.64 mA |
| AUX DAC2 | 0x11 | 7:0 | AUXDAC2<7:0> | Auxiliary DAC2 10-bit output current adjustment word |
| | | 1:0 | AUXDAC2<9:8> | 0x03FF, sets output current magnitude to 2.0 mA 0x0200, sets output current to 1.0 mA 0x0000, sets output current to 0.0 mA |
| | 0x12 | 7 | AUX2PIN | 1, AUX2P output pin is active 0, AUX2N output pin is active |
| | | 6 | AUX2DIR | 0, configures AUX2 DAC output to source current 1, configures AUX2 DAC output to sink current |

DIGITAL INPUTS AND OUTPUTS

The AD9741/AD9743/AD9745/AD9746/AD9747 can operate in two data input modes: dual-port mode and single-port mode. For the default dual-port mode (ONEPORT = 0), each DAC receives data from a dedicated input port. In single-port mode (ONEPORT = 1), however, both DACs receive data from Port 1. In single-port mode, DAC1 and DAC2 data is interleaved and the IQSEL input is used to steer data to the correct DAC.

In single-port mode, when the IQSEL input is high, Port 1 data is delivered to DAC1 and when IQSEL is low, Port 1 data is delivered to DAC2. The IQSEL input should always coincide and be time-aligned with the other data bus signals. In single-port mode, minimum setup and hold times apply to the IQSEL input as well as to the input data signals. In dual-port mode, the IQSEL input is ignored.

In dual-port mode, the data must be delivered at the sample rate (up to 250 MSPS). In single-port mode, data must be delivered at twice the sample rate. Because the data inputs function only up to 250 MSPS, it is only practical to operate the DAC clock at up to 125 MHz in single-port mode.

In both dual-port and single-port modes, a data clock output (DCO) signal is available as a fixed time base with which to stimulate data from an FPGA. This output signal always operates at the sample rate. It may be inverted by asserting the INVDCO bit.

INPUT DATA TIMING

With most DACs, signal-to-noise ratio (SNR) is a function of the relationship between the position of the clock edges and the point in time at which the input data changes. The AD9741/AD9743/AD9745/AD9746/AD9747 are rising edge triggered and thus exhibit greater SNR sensitivity when the data transition is close to this edge.

The specified minimum setup and hold times define a window of time, within each data period, where the data is sampled correctly. Generally, users should position data to arrive relative to the DAC clock and well beyond the minimum setup and minimum hold times. This becomes increasingly more important at increasingly higher sample rates.

DUAL-PORT MODE TIMING

The timing diagram for the dual-port mode is shown in Figure 27.

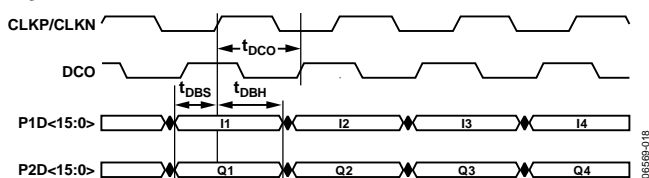

Figure 27. Data Interface Timing, Dual-Port Mode

In Figure 27, data samples for DAC1 are labeled Ix and data samples for DAC2 are labeled Qx. Note that the differential DAC clock input is shown in a logical sense (CLKP/CLKN). The data clock output is labeled DCO.

Setup and hold times are referenced to the positive transition of the DAC clock. Data should arrive at the input pins such that the minimum setup and hold times are met. Note that the data clock output has a fixed time delay from the DAC clock and may be a more convenient signal to use to confirm timing.

SINGLE-PORT MODE TIMING

The single-port mode timing diagram is shown in Figure 28.

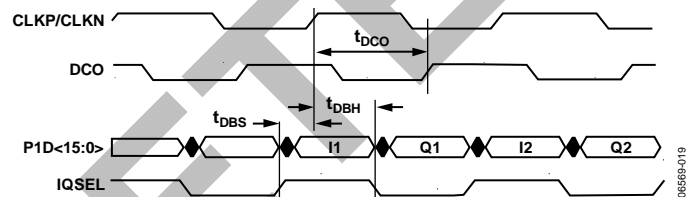

Figure 28. Data Interface Timing, Single-Port Mode

In single-port mode, data for both DACs is received on the Port 1 input bus. Ix and Qx data samples are interleaved and arrive twice as fast as in dual-port mode. Accompanying the data is the IQSEL input signal, which steers incoming data to its respective DAC. When IQSEL is high, data is steered to DAC1 and when IQSEL is low, data is steered to DAC2. IQSEL should coincide as well as be time-aligned with incoming data.

SPI PORT, RESET, AND PIN MODE

In general, when the AD9741/AD9743/AD9745/AD9746/AD9747 are powered up, an active high pulse applied to the RESET pin should follow. This insures the default state of all control register bits. In addition, once the RESET pin goes low, the SPI port can be activated, so CSB should be held high.

For applications without a controller, the AD9741/AD9743/AD9745/AD9746/AD9747 also support pin mode operation, which allows some functional options to be pin, selected without the use of the SPI port. Pin mode is enabled anytime the RESET pin is held high. In pin mode, the four SPI port pins take on secondary functions, as shown in Table 16.

Table 16. SPI Pin Functions (Pin Mode)

| Pin Name | Pin Mode Description |
|----------|--|
| SCLK | ONEPORT (Register 0x02, Bit 6), bit value (1/0) equals pin state (high/low) |
| SDIO | DATYPE (Register 0x02, Bit 7), bit value (1/0) equals pin state (high/low) |
| CSB | Enable Mix Mode, if CSB is high, Register 0x0A is set to 0x05 putting both DAC1 and DAC2 into mix mode |
| SDO | Enable full power-down, if SDO is high, Register 0x03 is set to 0xFF |

In pin mode, all register bits are reset to their default values with the exception of those that are controlled by the SPI pins.

Note also that the RESET pin should be allowed to float and must be pulled low. Connect an external 10 kΩ resistor to DVSS. This avoids unexpected behavior in noisy environments.

DRIVING THE DAC CLOCK INPUT

The DAC clock input requires a low jitter drive signal. It is a PMOS differential pair powered from the CVDD18 supply. Each pin can safely swing up to 800 mV p-p at a common-mode voltage of about 400 mV. Though these levels are not directly LVDS-compatible, CLKP and CLKN can be driven by an ac-coupled, dc-offset LVDS signal, as shown in Figure 29.

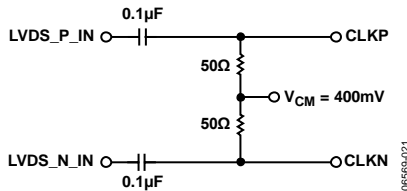

Figure 29. LVDS DAC Clock Drive Circuit

Using a CMOS or TTL clock is also acceptable for lower sample rates. It can be routed through an LVDS translator and then ac-coupled as described previously, or alternatively, it can be transformer-coupled and clamped, as shown in Figure 30.

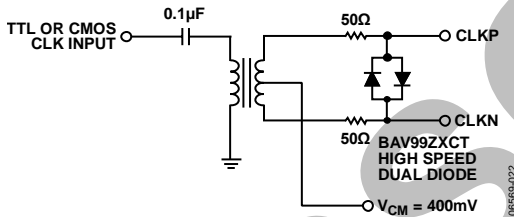

Figure 30. TTL or CMOS DAC Clock Drive Circuit

If a sine wave signal is available, it can be transformer-coupled directly to the DAC clock inputs, as shown in Figure 31.

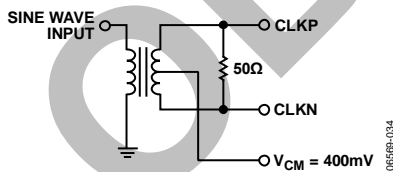

Figure 31. Sine Wave DAC Clock Drive Circuit

The 400 mV common-mode bias voltage can be derived from the CVDD18 supply through a simple divider network, as shown in Figure 32.

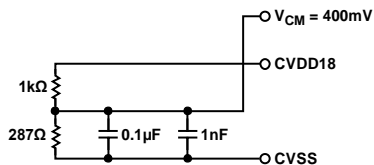

Figure 32. DAC Clock VCM Circuit

It is important to use CVDD18 and CVSS for any clock bias circuit as noise that is coupled onto the clock from another power supply is multiplied by the DAC input signal and degrades performance.

FULL-SCALE CURRENT GENERATION

The full-scale currents on DAC1 and DAC2 are functions of the current drawn through an external resistor connected to the FSADJ pin (Pin 54). The required value for this resistor is 10 kΩ. An internal amplifier sets the current through the resistor to force a voltage equal to the band gap voltage of 1.2 V. This develops a reference current in the resistor of 120 μA.

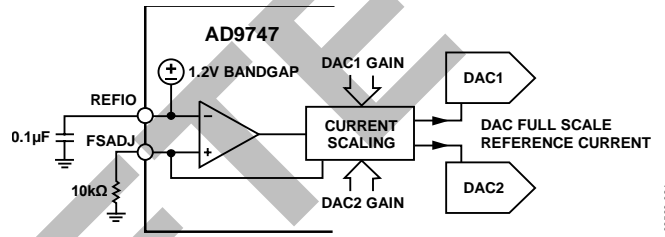

Figure 33. Reference Circuitry

REFIO (Pin 55) should be bypassed to ground with a 0.1 μF capacitor. The band gap voltage is present on this pin and can be buffered for use in external circuitry. The typical output impedance is near 5 kΩ. If desired, an external reference can be connected to REFIO to overdrive the internal reference.

Internal current mirrors provide a means for adjusting the DAC full-scale currents. The gain for DAC1 and DAC2 can be adjusted independently by writing to the DAC1FSC<9:0> and DAC2FSC<9:0> register bits. The default value of 0x01F9 for the DAC gain registers gives an I_{FS} of 20 mA, where I_{FS} equals

$$I_{FS} = \frac{1.2 V}{10,000} \times \left(72 + \left(\frac{3}{16} \times DAC\ n\ FSC \right) \right)$$

The full-scale output current range is 8.6 mA to 31.7 mA for register values 0x000 to 0x3FF.

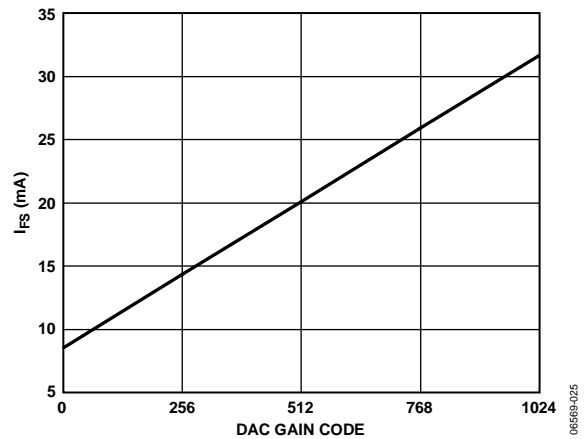

Figure 34. I_{FS} vs. DAC Gain Code

DAC TRANSFER FUNCTION

Each DAC output of the [AD9741/AD9743/AD9745/AD9746/AD9747](#) drives complementary current outputs I_{OUTP} and I_{OUTN} . I_{OUTP} provides a near full-scale current output (I_{FS}) when all bits are high. For example,

$$DAC\ CODE = 2^N - 1$$

where:

$N = 8\text{-}/10\text{-}/12\text{-}/14\text{-}/16\text{-bits}$ (for [AD9741/AD9743/AD9745/AD9746/AD9747](#) respectively), and I_{OUTN} provides no current.

The current output appearing at I_{OUTP} and I_{OUTN} is a function of both the input code and I_{FS} and can be expressed as

$$I_{OUTP} = (DAC\ DATA/2^N) \times I_{FS} \quad (1)$$

$$I_{OUTN} = ((2^N - 1) - DAC\ DATA)/2^N \times I_{FS} \quad (2)$$

where $DAC\ DATA = 0$ to $2^N - 1$ (decimal representation).

The two current outputs typically drive a resistive load directly or via a transformer. If dc coupling is required, I_{OUTP} and I_{OUTN} should be connected to matching resistive loads (R_{LOAD}) that are tied to analog common (AVSS). The single-ended voltage output appearing at the I_{OUTP} and I_{OUTN} pins is

$$V_{OUTP} = I_{OUTP} \times R_{LOAD} \quad (3)$$

$$V_{OUTN} = I_{OUTN} \times R_{LOAD} \quad (4)$$

Note that to achieve the maximum output compliance of 1 V at the nominal 20 mA output current, R_{LOAD} must be set to 50 Ω . Also note that the full-scale value of V_{OUTP} and V_{OUTN} should not exceed the specified output compliance range to maintain specified distortion and linearity performance.

There are two distinct advantages to operating the [AD9741/AD9743/AD9745/AD9746/AD9747](#) differentially. First, differential operation helps cancel common-mode error sources associated with I_{OUTP} and I_{OUTN} , such as noise, distortion, and dc offsets. Second, the differential code dependent current and subsequent output voltage (V_{DIFF}) is twice the value of the single-ended voltage output (V_{OUTP} or V_{OUTN}), providing 2 \times signal power to the load.

$$V_{DIFF} = (I_{OUTP} - I_{OUTN}) \times R_{LOAD} \quad (5)$$

ANALOG MODES OF OPERATION

The [AD9741/AD9743/AD9745/AD9746/AD9747](#) utilize a proprietary quad-switch architecture that lowers the distortion of the DAC output by eliminating a code dependent glitch that occurs with conventional dual-switch architectures. But whereas this architecture eliminates the code dependent glitches, it creates a constant glitch at a rate of $2 \times f_{DAC}$. For communications

systems and other applications requiring good frequency domain performance, this is seldom problematic.

The quad-switch architecture also supports two additional modes of operation; mix mode and return-to-zero (RZ) mode. The waveforms of these two modes are shown in Figure 35. In mix mode, the output is inverted every other half clock cycle. This effectively chops the DAC output at the sample rate. This chopping has the effect of frequency shifting the sinc roll-off from dc to f_{DAC} . Additionally, there is a second subtle effect on the output spectrum. The shifted spectrum is shaped by a second sinc function with a first null at $2 \times f_{DAC}$. The reason for this shaping is that the data is not continuously varying at twice the clock rate, but is simply repeated.

In RZ mode, the output is set to midscale on every other half clock cycle. The output is similar to the DAC output in normal mode except that the output pulses are half the width and half the area. Because the output pulses have half the width, the sinc function is scaled in frequency by 2 and has a first null at $2 \times f_{DAC}$. Because the area of the pulses is half that of the pulses in normal mode, the output power is half the normal mode output power.

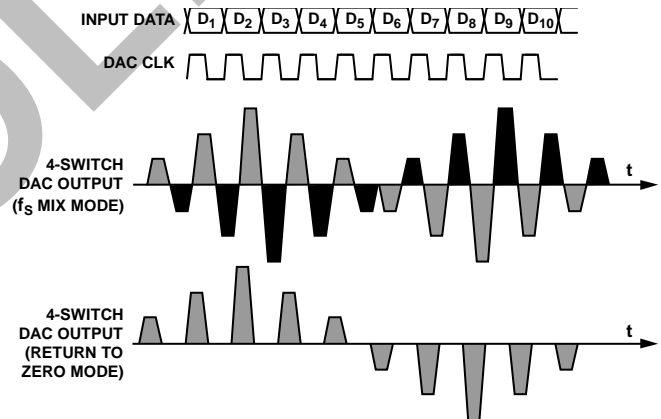

Figure 35. Mix Mode and RZ Mode DAC Waveforms

The functions that shape the output spectrums for normal mode, mix mode, and RZ mode, are shown in Figure 36. Switching between the modes reshapes the sinc roll off inherent at the DAC output. This ability to change modes in the [AD9741/AD9743/AD9745/AD9746/AD9747](#) makes the parts suitable for direct IF applications. The user can place a carrier anywhere in the first three Nyquist zones depending on the operating mode selected. The performance and maximum amplitude in all three zones are impacted by this sinc roll off depending on where the carrier is placed, as shown in Figure 36.

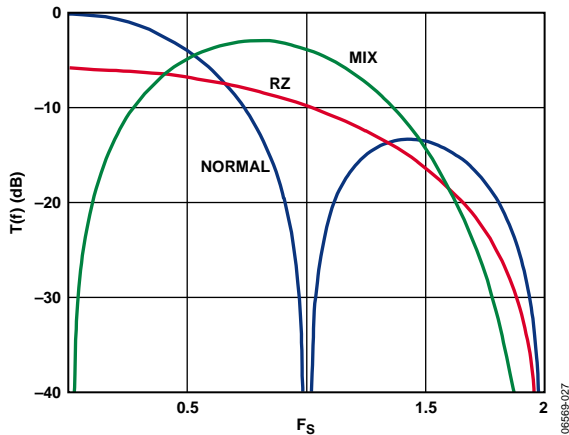

Figure 36. Transfer Function for Each Analog Operating Mode

AUXILIARY DACS

Two auxiliary DACs are provided on the AD9741/AD9743/AD9745/AD9746/AD9747. A functional diagram is shown in Figure 37. The auxiliary DACs are current output devices with two output pins, AUXP and AUXN. The active pin can be programmed to either source or sink current. When either sinking or sourcing, the full-scale current magnitude is 2 mA. The available compliance range at the auxiliary DAC outputs depends on whether the output is configured to a sink or source current. When sourcing current, the compliance voltage is 0 V to 1.6 V, but when sinking current, the output compliance voltage reduces to 0.8 V to 1.6 V. Either output can be used, but only one output of the auxiliary DAC (P or N) is active at any time. The inactive pin is always in a high impedance state (>100 kΩ).

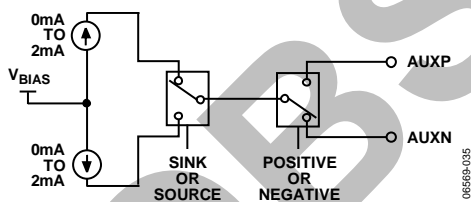

Figure 37. Auxiliary DAC Functional Diagram

In a single side band transmitter application, the combination of the input referred dc offset voltage of the quadrature modulator and the DAC output offset voltage can result in local oscillator (LO) feedthrough at the modulator output, which degrades system performance. The auxiliary DACs can be used to remove the dc offset and the resulting LO feedthrough. The circuit configuration for using the auxiliary DACs for performing dc offset correction depends on the details of the DAC and modulator interface. An example of a dc-coupled configuration with low-pass filtering is outlined in the Power Dissipation section.

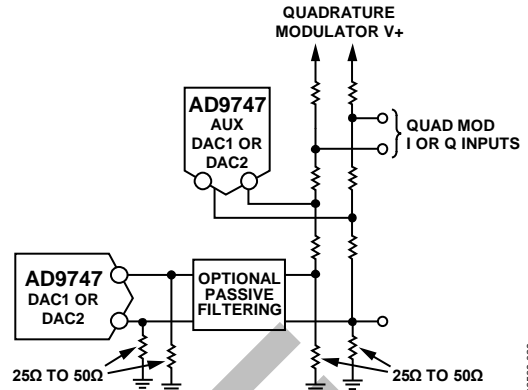

Figure 38. DAC DC Coupled to Quadrature Modulator with Passive DC Shift

POWER DISSIPATION

Figure 39 shows the power dissipation and current draw of the AD9741/AD9743/AD9745/AD9746/AD9747. It shows that the devices have a quiescent power dissipation of about 190 mW. Most of this comes from the AVDD33 supply. Total power dissipation increases about 50% as the clock rate is increased to the maximum clock rate of 250 MHz.

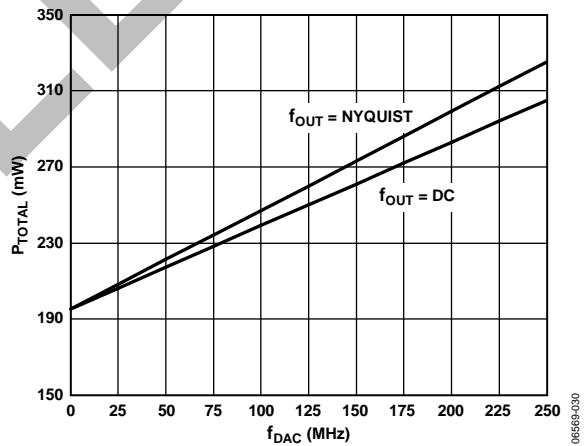

Figure 39. AD9747 Power Dissipation vs. f_{DAC}

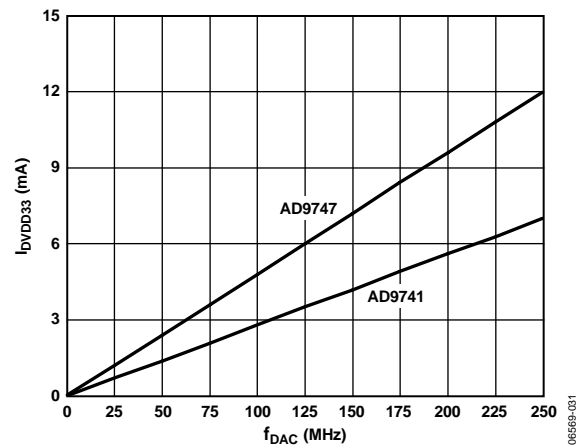

Figure 40. DVDD33 Current vs. f_{DAC}

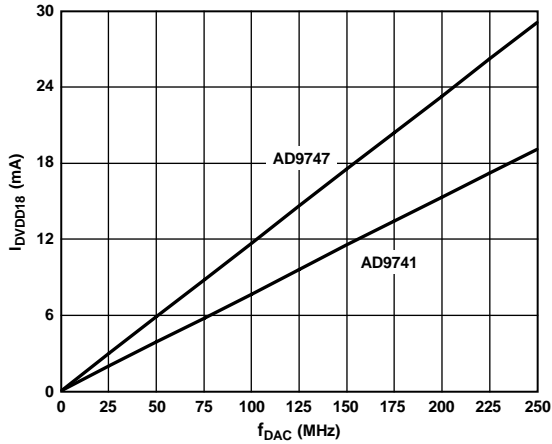

Figure 41. DVDD18 Current vs. f_{DAC}

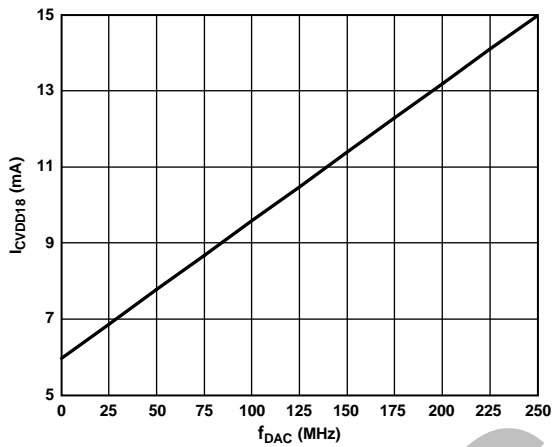

Figure 42. CVDD18 Current vs. f_{DAC}

Figure 43 shows the power consumption for each power supply domain as well as the total power consumption. Individual bars within each group display the power in full active mode (blue) vs. power for five increasing levels of power-down.

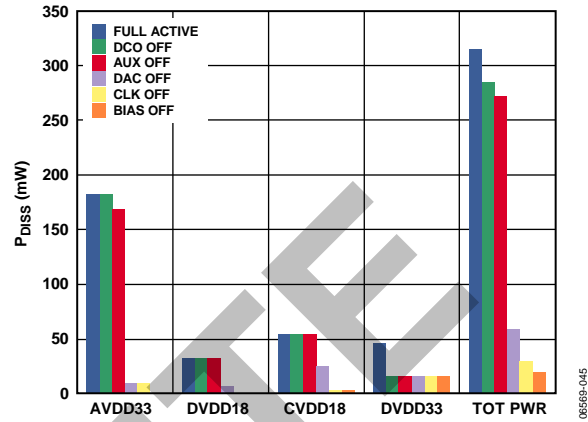
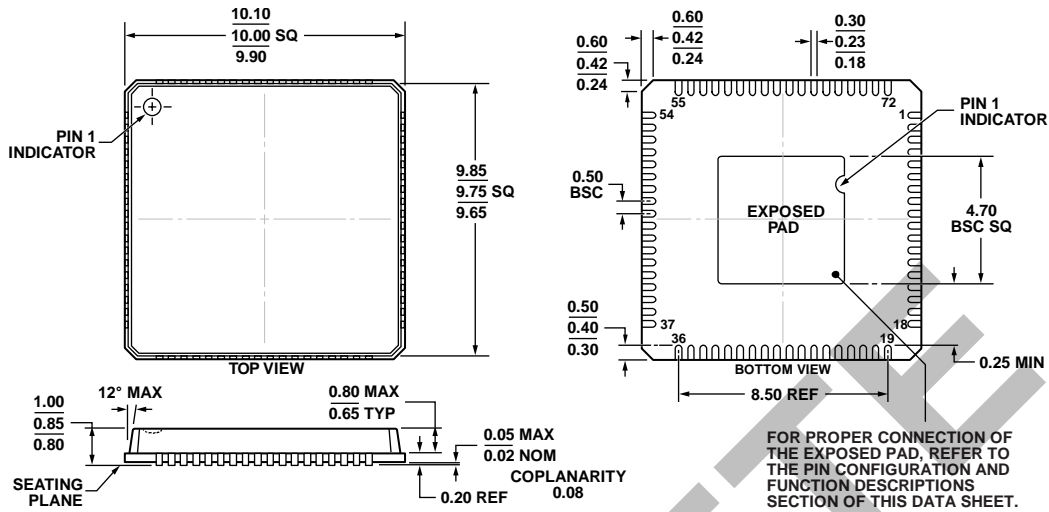

Figure 43. Power Dissipation vs. Power-Down Mode

The overall power consumption is dominated by AVDD33 and significant power savings can be achieved simply by disabling the DAC outputs. Also, disabling the DAC outputs is a significant way to conserve power and still maintain a fast wake-up time. Full power-down disables all circuitry for minimum power consumption. Note, however, that even in full power-down, there is a small power draw (25 mW) due to incoming data activity. To lower power consumption to near zero, all incoming data activity must be halted.

OUTLINE DIMENSIONS



COMPLIANT TO JEDEC STANDARDS MO-220-VNND-4

Figure 44. 72-Lead Lead Frame Chip Scale Package [LFCSP_VQ]
 10 mm × 10 mm, Very Thin Quad
 (CP-72-1)
 Dimensions shown in millimeters

06-15-2012-A

ORDERING GUIDE

| Model ¹ | Temperature Range | Package Description | Package Option |
|--------------------|-------------------|---------------------|----------------|
| AD9741BCPZ | -40°C to +85°C | 72-Lead LFCSP_VQ | CP-72-1 |
| AD9741BCPZRL | -40°C to +85°C | 72-Lead LFCSP_VQ | CP-72-1 |
| AD9743BCPZ | -40°C to +85°C | 72-Lead LFCSP_VQ | CP-72-1 |
| AD9743BCPZRL | -40°C to +85°C | 72-Lead LFCSP_VQ | CP-72-1 |
| AD9745BCPZ | -40°C to +85°C | 72-Lead LFCSP_VQ | CP-72-1 |
| AD9745BCPZRL | -40°C to +85°C | 72-Lead LFCSP_VQ | CP-72-1 |
| AD9746BCPZ | -40°C to +85°C | 72-Lead LFCSP_VQ | CP-72-1 |
| AD9746BCPZRL | -40°C to +85°C | 72-Lead LFCSP_VQ | CP-72-1 |
| AD9747BCPZ | -40°C to +85°C | 72-Lead LFCSP_VQ | CP-72-1 |
| AD9747BCPZRL | -40°C to +85°C | 72-Lead LFCSP_VQ | CP-72-1 |
| AD9741-DPG2-EBZ | | Evaluation Board | |
| AD9743-DPG2-EBZ | | Evaluation Board | |
| AD9745-DPG2-EBZ | | Evaluation Board | |
| AD9746-DPG2-EBZ | | Evaluation Board | |
| AD9747-DPG2-EBZ | | Evaluation Board | |

¹ Z = RoHS Compliant Part.

NOTES

OBSOLETE