

LOW NOISE AMPLIFIER MODULE, 1.8 - 4.2 GHz

Features

- Noise Figure: 1.2 dB @ 2.4 GHz
- Gain: 26 dB
- OIP3: +26 dBm
- P1dB Output Power: +15.5 dBm
- 50 Ohm Matched Input/Output
- Hermetically Sealed Module
- Field Replaceable SMA Connectors
- 55 °C to +85 °C Operating Temperature

Typical Applications

The HMC-C045 LNA is ideal for:

- Telecom Infrastructure
- Microwave Radio & VSAT
- Military & Space
- Test Instrumentation

General Description

The HMC-C045 is a GaAs MMIC pHEMT Low Noise Amplifier in a miniature, hermetic module which operates between 1.8 and 4.2 GHz. This high dynamic range low noise amplifier module provides 26 dB of gain, sub-2 dB noise figure and up to +26 dBm of output IP3 while operating from a single positive supply between +8V and +15V. The amplifier I/Os are internally matched to 50 Ohms and DC blocked for robust performance. The module features removable coaxial connectors which can be detached to allow direct connection of the I/O pins to a microstrip or coplanar circuit.

Functional Diagram

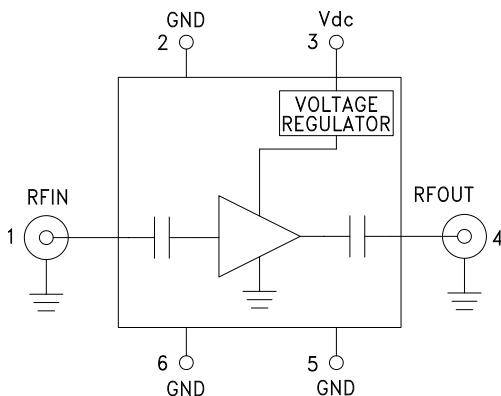

Electrical Specifications, $T_A = +25^\circ\text{C}$, $V_{dc} = +12\text{V}$

Parameter	Min.	Typ.	Max.	Min.	Typ.	Max.	Units
Frequency Range	1.8 - 4.2			2.0 - 3.8			GHz
Gain	23	26		23	26		dB
Gain Variation Over Temperature		0.03	0.05		0.03	0.05	dB/ °C
Noise Figure		1.2	2.5		1.2	2.0	dB
Input Return Loss		13			13		dB
Output Return Loss		13			13		dB
Output Power for 1 dB Compression (P1dB)	12.5	15.5		12.5	15.5		dBm
Saturated Output Power (Psat)		17.5			17.5		dBm
Output Third Order Intercept (IP3)		26			26		dBm
Supply Current		105	140		105	140	mA



**LOW NOISE AMPLIFIER
MODULE, 1.8 - 4.2 GHz**

Broadband Gain & Return Loss

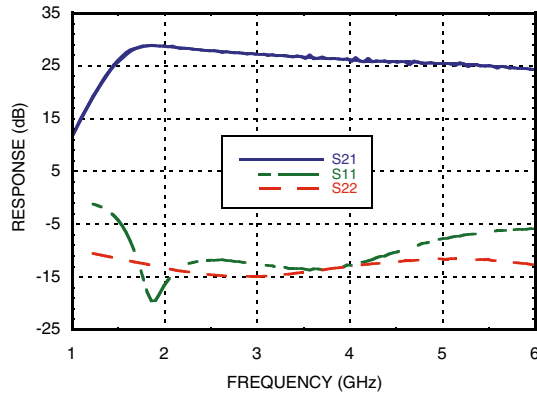

Gain vs. Temperature

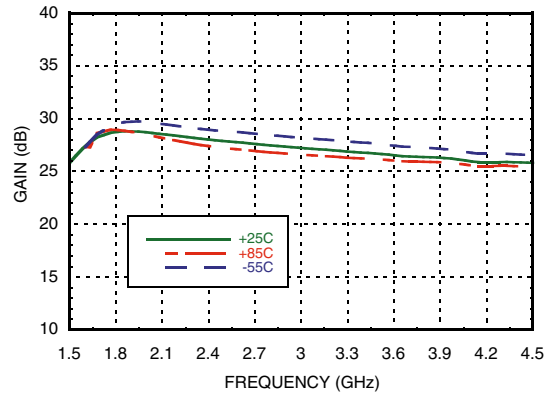

Input Return Loss vs. Temperature

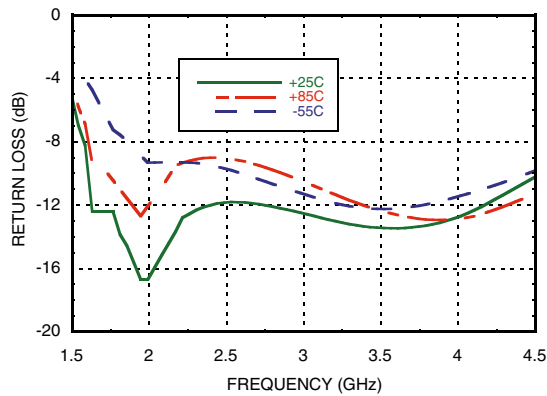

Output Return Loss vs. Temperature

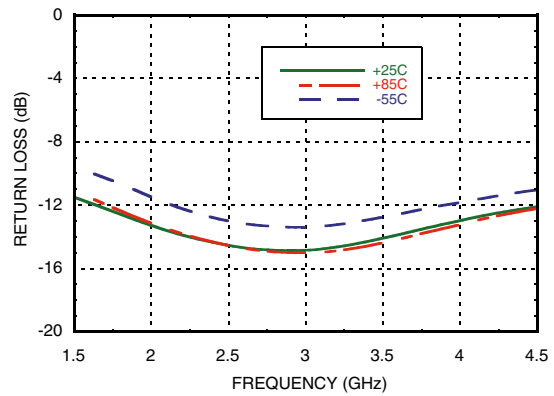

Reverse Isolation vs. Temperature

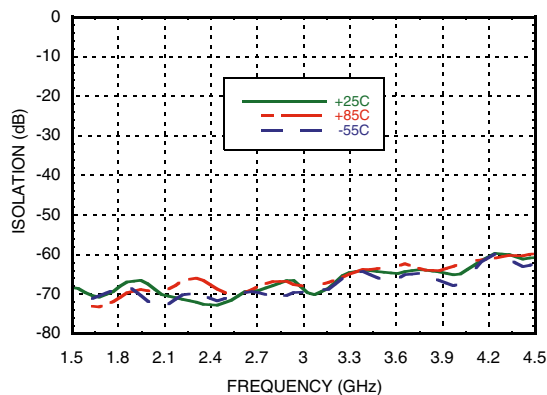

Noise Figure vs. Temperature

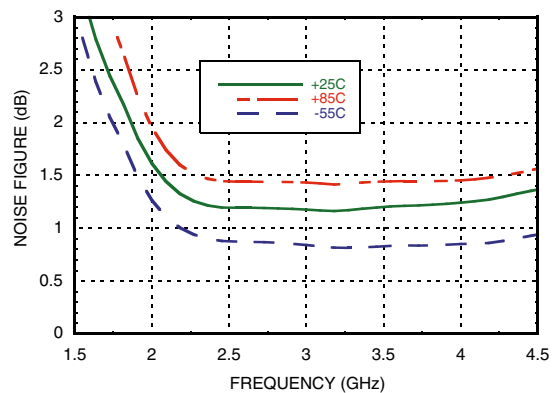

Information furnished by Analog Devices is believed to be accurate and reliable. However, no responsibility is assumed by Analog Devices for its use, nor for any infringements of patents or other rights of third parties that may result from its use. Specifications subject to change without notice. No license is granted by implication or otherwise under any patent or patent rights of Analog Devices. Trademarks and registered trademarks are the property of their respective owners.

For price, delivery, and to place orders: Analog Devices, Inc., One Technology Way, P.O. Box 9106, Norwood, MA 02062-9106 Phone: 781-329-4700 • Order online at www.analog.com Application Support: Phone: 1-800-ANALOG-D



**LOW NOISE AMPLIFIER
MODULE, 1.8 - 4.2 GHz**

Output P1dB vs. Temperature

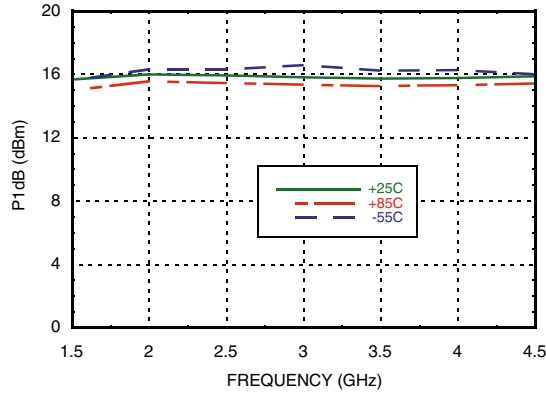

Output Psat vs. Temperature

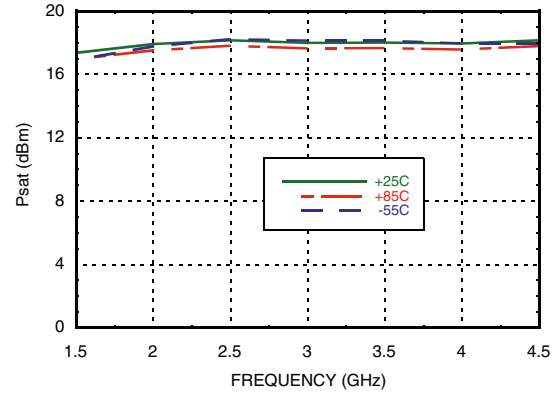

Output IP3 vs. Temperature

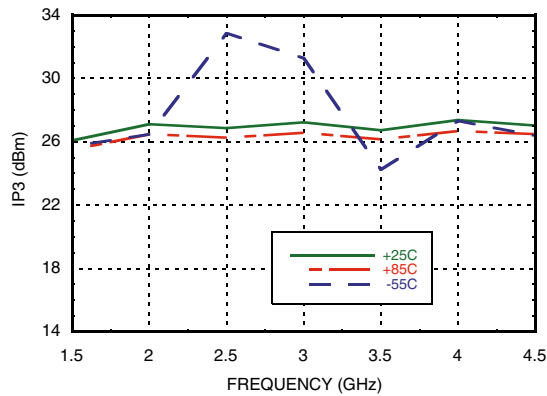

Absolute Maximum Ratings

Bias Supply Voltage (Vdc)	+15 Vdc
RF Input Power (RFIN)	+0 dBm
Storage Temperature	-65 to +150 °C
Operating Temperature	-55 to +85 °C





**ELECTROSTATIC SENSITIVE DEVICE
OBSERVE HANDLING PRECAUTIONS**

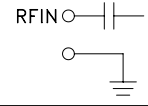

LOW NOISE AMPLIFIER MODULE, 1.8 - 4.2 GHz

Pin Descriptions

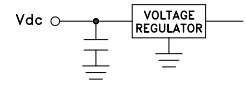
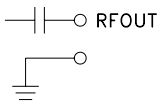
Pin Number	Function	Description	Interface Schematic
1	RFIN & RF Ground	RF input connector, coaxial female, field replaceable. This pin is AC coupled and matched to 50 Ohms.	
2, 5, 6	GND	One of these pins must be connected to power supply ground.	
3	Vdc	Power supply voltage for the amplifier.	
4	RFOUT & RF Ground	RF output connector, coaxial female, field replaceable. This pin is AC coupled and matched to 50 Ohms.	



LOW NOISE AMPLIFIER MODULE, 1.8 - 4.2 GHz

Outline Drawing

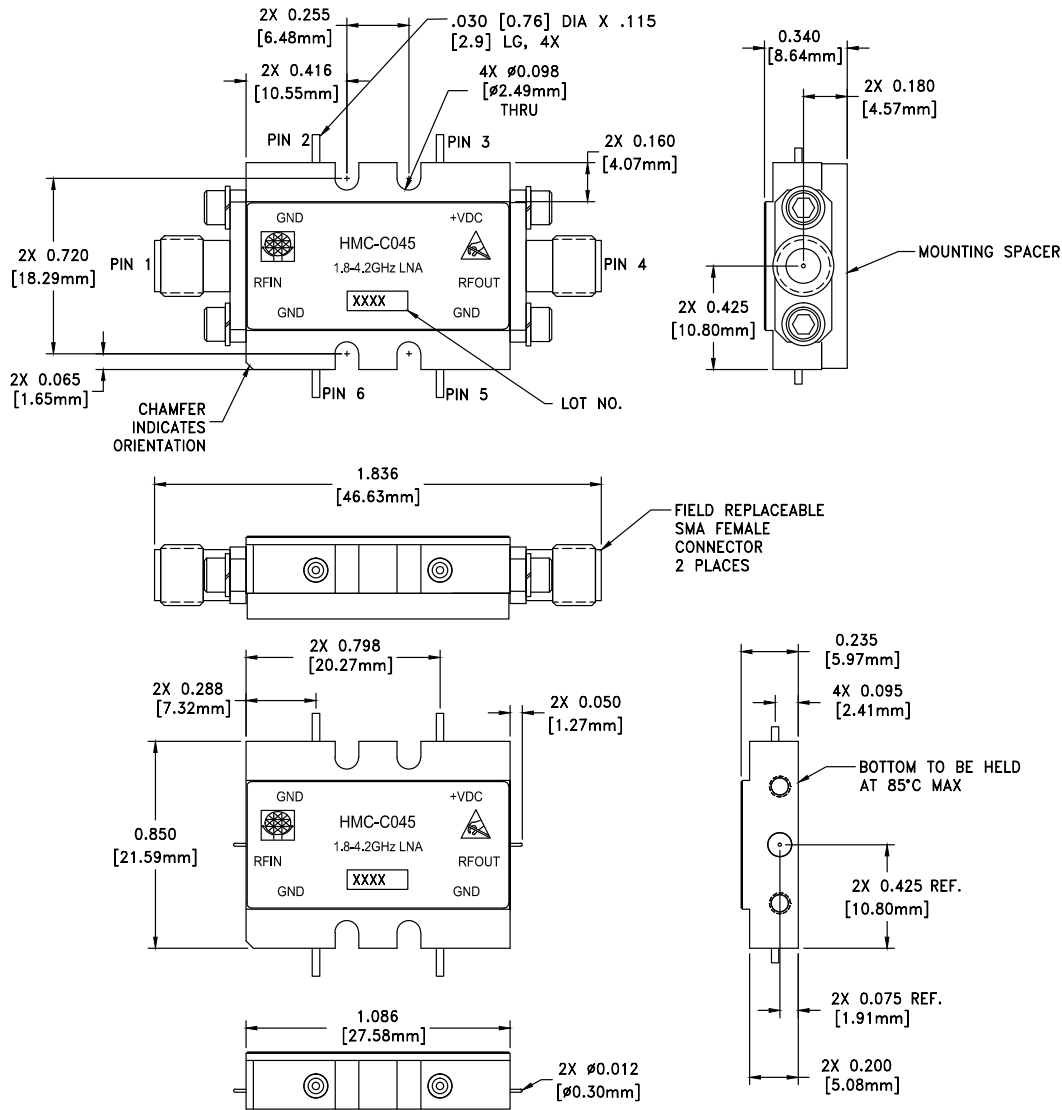

VIEW SHOWN WITH CONNECTORS AND MOUNTING SPACER REMOVED

Package Information

Package Type	C-10
Package Weight [1]	18.7 gms [2]
Spacer Weight	3.3 gms [2]

[1] Includes the connectors

[2] ±1 gms Tolerance

NOTES:

1. PACKAGE, LEADS, COVER MATERIAL: KOVAR™
2. FINISH: GOLD PLATE OVER NICKEL PLATE
3. ALL DIMENSIONS ARE IN INCHES [MILLIMETERS]
4. TOLERANCES:
 - 4.1 .XX = ±0.02
 - 4.2 .XXX = ±0.010
5. FIELD REPLACEABLE SMA CONNECTORS

Information furnished by Analog Devices is believed to be accurate and reliable. However, no responsibility is assumed by Analog Devices for its use, nor for any infringements of patents or other rights of third parties that may result from its use. Specifications subject to change without notice. No license is granted by implication or otherwise under any patent or patent rights of Analog Devices. Trademarks and registered trademarks are the property of their respective owners.

For price, delivery, and to place orders: Analog Devices, Inc., One Technology Way, P.O. Box 9106, Norwood, MA 02062-9106 Phone: 781-329-4700 • Order online at www.analog.com Application Support: Phone: 1-800-ANALOG-D

**LOW NOISE AMPLIFIER
MODULE, 1.8 - 4.2 GHz****Notes:**