



FEATURES

- UL 60950 recognised
- RoHS compliant
- 4:1 Wide range voltage input
- Operating temperature range -40°C to 85°C
- Typical load regulation from 0.06%
- 1.5kVDC isolation
- Typical efficiency to 87%
- 12V & 48V nominal input
- Power density $0.94\text{W}/\text{cm}^3$
- UL 94V-0 package materials
- No electrolytic capacitors
- Low noise
- Under voltage lock out
- Current fold back

PRODUCT OVERVIEW

The NCS6 series of DC-DC converters offers single & dual output voltages from input voltage ranges of 9-36V and 18-75V. The NCS6 is housed in an industry standard package with a standard pinout. The NCS6 is packaged in a metal case for improved EMI shielding and is also encapsulated for superior thermal performance.

Applications include telecommunications, battery powered systems, process control and distributed power systems.



For full details go to www.murata-ps.com/rohs



SELECTION GUIDE

Order Code	Input Voltage	Output Voltage	Output Current 100% Load	Input Current		Ripple & Noise (Typ.)	Efficiency		MTTF ¹
	Nom.			0% Load	100% Load		Min.	Typ.	
	V	V	A	mA	mA	mV p-p	%	%	Hrs
NCS6D1205C	12	±5	±0.6	7	610	15	80	82	384,470
NCS6D1212C	12	±12	±0.25	10	580	10	82	86	406,121
NCS6D1215C	12	±15	±0.2	12	580	20	84	87	344,957
NCS6S1203C	12	3.3	1.52	10	550	30	75	78	662,073
NCS6S1205C	12	5	1.2	7	610	30	79	82	521,975
NCS6S1212C	12	12	0.5	10	580	30	84	86	435,567
NCS6S1215C	12	15	0.4	12	580	30	85	87	437,582
NCS6D4805C	48	±5	±0.6	6	160	50	79	80	373,195
NCS6D4812C	48	±12	±0.25	7	150	30	82	84	391,563
NCS6D4815C	48	±15	±0.2	7	150	30	82	84	330,752
NCS6S4803C	48	3.3	1.52	10	150	40	73	76	483,460
NCS6S4805C	48	5	1.2	6	160	30	78	80	441,850
NCS6S4812C	48	12	0.5	7	150	30	82	84	408,555
NCS6S4815C	48	15	0.4	7	150	30	83	84	416,319

INPUT CHARACTERISTICS

Parameter	Conditions	Min.	Typ.	Max.	Units
Voltage range	12V input types	9	12	36	V
	48V input types	18	48	75	
Under voltage lock out	Turn on threshold 12V input types		8.5		V
	Turn off threshold 12V input types		7.5		
	Turn on threshold 48V input types		16.7		
	Turn off threshold 48V input types		15.8		
Reflected ripple current	12V input types	Single output types	12		mA p-p
		Dual output types	4		
	48V input types	Single output types	9		
		Dual output types	6		

OUTPUT CHARACTERISTICS

Parameter	Conditions	Min.	Typ.	Max.	Units
Rated power	5V, 12V & 15V output types			6	W
	3.3V output types			5	
Voltage set point accuracy	Positive outputs			±2	%
	Negative outputs			±3	
Line regulation	Low line to high line	Positive outputs	0.002	0.2	%
		Negative outputs	0.09	0.7	
Load Regulation	10% total load to 100% total load	3V outputs	0.5	0.6	%
		5V positive outputs	0.3	0.5	
		12V & 15V positive outputs	0.06	0.2	
		All negative outputs	0.2	1.0	
Cross Regulation	% voltage change on negative output when positive load varies from 12.5% to 37.5% with negative load fixed at 50%	5V		5	%
		12V & 15V		2.5	
Start-up Time	3.3V & 5V output types	Single output types	2.5		mS
		Dual output types	25		
	12V output types	Single output types	4.6		
		Dual output types	11		
	15V output types	Single output types	5.5		
		Dual output types	14		

¹ Calculated using MIL-HDBK-217F FN2, parts stress method with nominal input voltage at full load. All specifications typical at TA=25°C, nominal input voltage and rated output current unless otherwise specified.

ISOLATION CHARACTERISTICS

Parameter	Conditions	Min.	Typ.	Max.	Units
Isolation test voltage	Flash tested for 1 seconds	1500			VDC
Resistance	Viso = 1kVDC	1			GΩ
Capacitance			225		pF

GENERAL CHARACTERISTICS¹

Parameter	Conditions	Min.	Typ.	Max.	Units
Switching frequency			180		kHz

TEMPERATURE CHARACTERISTICS

Parameter	Conditions	Min.	Typ.	Max.	Units
Operation	All output types (see derating graphs)	-40		85	°C
Storage		-50		125	
Case temperature rise above ambient	100% Load, Nom V _{IN} , Still Air	48V _{IN} Dual outputs	5V	36	
			12V	32	
			15V	31	
		All other output types	3.3V	32	
			5V	32	
			12V	28	
			15V	26	
Thermal shutdown	Case Temperature		105		

ABSOLUTE MAXIMUM RATINGS

Short-circuit protection (for SELV input voltages)	Continuous
Internal power dissipation	2.1W
Lead temperature 1.0mm from case for 10 seconds (to JEDEC JESD22-B106 ISS C)	260°C
Minimum output load for specification (see application notes)	10% of rated load
Wave solder	Wave Solder profile not to exceed the profile recommended in IEC 61760-1 Section 6.1.3. Please refer to application notes for further information.
Input voltage, NCS6 12V input types	40V
Input voltage, NCS6 48V input types	80V

TECHNICAL NOTES

ISOLATION VOLTAGE

'Hi Pot Test', 'Flash Tested', 'Withstand Voltage', 'Proof Voltage', 'Dielectric Withstand Voltage' & 'Isolation Test Voltage' are all terms that relate to the same thing, a test voltage, applied for a specified time, across a component designed to provide electrical isolation, to verify the integrity of that isolation.

Murata Power Solutions NCS6 series of DC-DC converters are all 100% production tested at their stated isolation voltage. This is 1.5kVDC for 1 second.

A question commonly asked is, "What is the continuous voltage that can be applied across the part in normal operation?"

The NCS6 has been recognised by Underwriters Laboratory for functional isolation. Both input and output should normally be maintained within SELV limits i.e. less than 42.4V peak, or 60VDC. The isolation test voltage represents a measure of immunity to transient voltages and the part should never be used as an element of a safety isolation system. The part could be expected to function correctly with several hundred volts offset applied continuously across the isolation barrier; but then the circuitry on both sides of the barrier must be regarded as operating at an unsafe voltage and further isolation/insulation systems must form a barrier between these circuits and any user-accessible circuitry according to safety standard requirements.

REPEATED HIGH-VOLTAGE ISOLATION TESTING

It is well known that repeated high-voltage isolation testing of a barrier component can actually degrade isolation capability, to a lesser or greater degree depending on materials, construction and environment. The NCS6 series has an ER ferrite core, with no additional insulation between primary and secondary windings of enamelled wire. While parts can be expected to withstand several times the stated test voltage, the isolation capability does depend on the wire insulation. Any material, including this enamel (typically polyurethane) is susceptible to eventual chemical degradation when subject to very high applied voltages thus implying that the number of tests should be strictly limited. We therefore strongly advise against repeated high voltage isolation testing, but if it is absolutely required, that the voltage be reduced by 20% from specified test voltage.

This consideration equally applies to agency recognised parts rated for better than functional isolation where the wire enamel insulation is always supplemented by a further insulation system of physical spacing or barriers.

SAFETY APPROVAL

The NCS6 series has been recognised by Underwriters Laboratory (UL) to UL 60950 for functional insulation in a maximum ambient temperature of 85°C and/or case temperature limit of 120°C (case temperature measured on the face opposite the pins). File number E151252 applies.

Note: This series gained UL 60950 recognition for products manufactured on or after datecode G1114, any NCS6 parts manufactured before this date code should not be considered UL 60950 recognised. Any NCS6 that is UL recognised will be printed with the UL logo.

RoHS COMPLIANCE INFORMATION



This series is compatible with RoHS soldering systems with a peak wave solder temperature of 260°C for 10 seconds. Please refer to [application notes](#) for further information. The pin termination finish on this product series is a Gold flash (0.05-0.10 micron) over Nickel Preplate. The series is backward compatible with Sn/Pb soldering systems. For further information, please visit www.murata-ps.com/rohs

PART NUMBER STRUCTURE

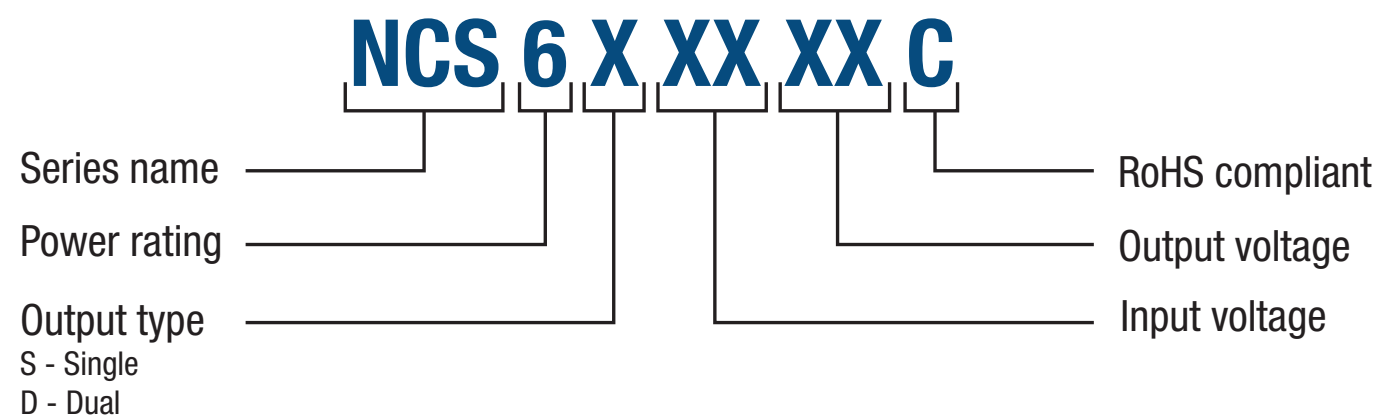

CHARACTERISATION TEST METHODS

Ripple & Noise Characterisation Method

Ripple and noise measurements are performed with the following test configuration.

C1	1µF X7R multilayer ceramic capacitor, voltage rating to be a minimum of 3 times the output voltage of the DC-DC converter
C2	10µF tantalum capacitor, voltage rating to be a minimum of 1.5 times the output voltage of the DC-DC converter with an ESR of less than 100mΩ at 100 kHz
C3	100nF multilayer ceramic capacitor, general purpose
R1	450Ω resistor, carbon film, ±1% tolerance
R2	50Ω BNC termination
T1	3T of the coax cable through a ferrite toroid
RLOAD	Resistive load to the maximum power rating of the DC-DC converter. Connections should be made via twisted wires
Measured values are multiplied by 10 to obtain the specified values.	

Differential Mode Noise Test Schematic

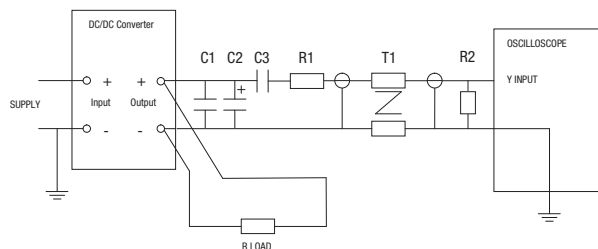

APPLICATION NOTES

Output Capacitors

The NCS6 series does not require output capacitors to meet datasheet specification. To meet datasheet specification, total output capacitance should not exceed:

Output Voltage (V)	Output Capacitance (µF)
3.3	470
5	470
12	220
15	220

Minimum Load

The minimum load to meet full datasheet specification is 10% of the full rated load across the specified input voltage range.

Between 0% and 10% output loading, the positive output voltage will remain within data sheet specification however, output ripple and noise will increase as well as a decrease in accuracy on negative outputs.

EFFICIENCY VS LOAD

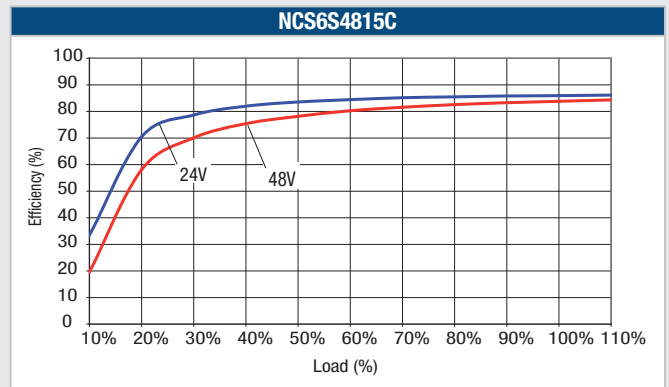
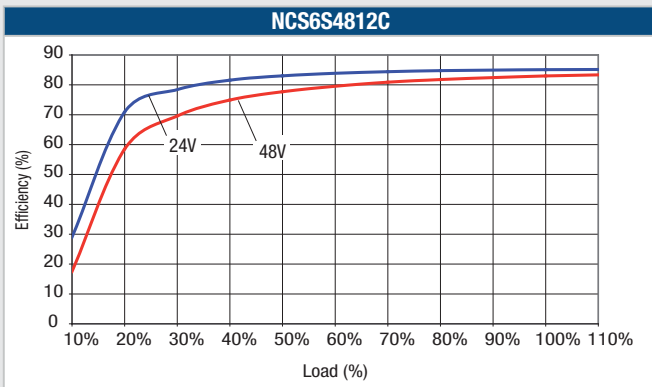
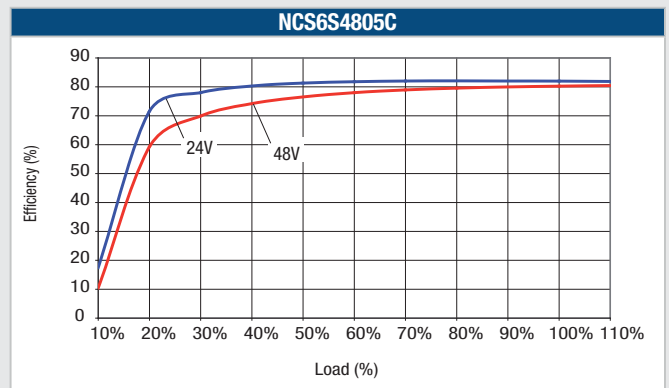
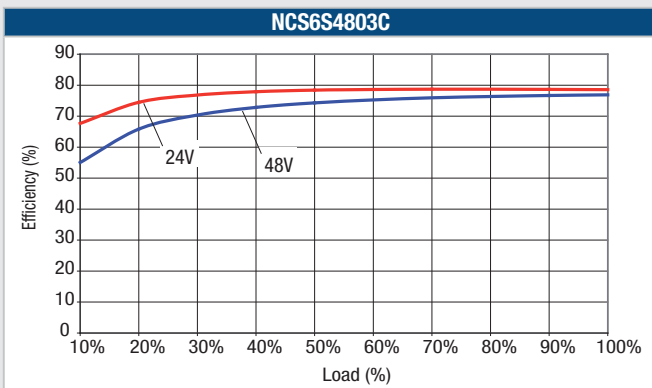
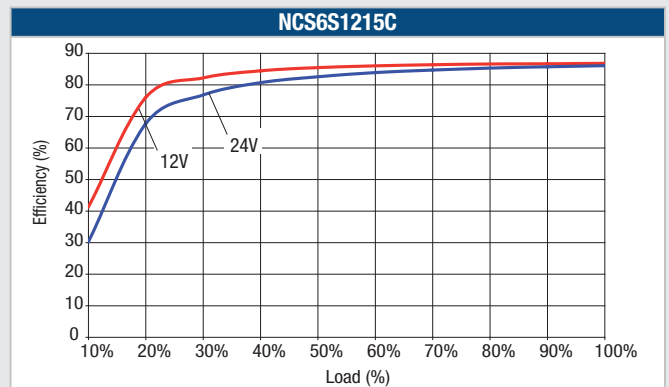
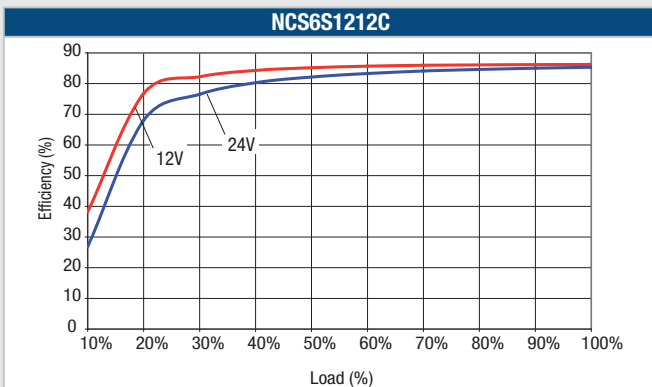
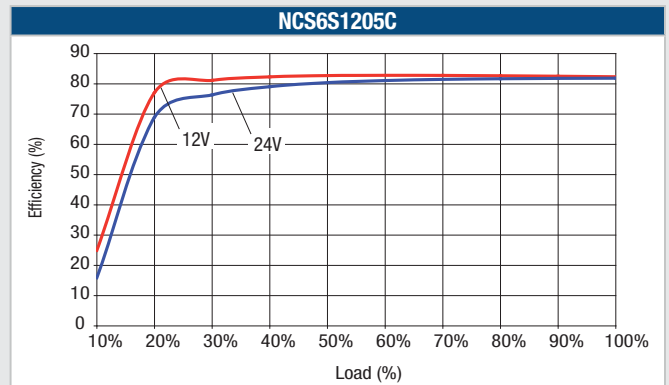
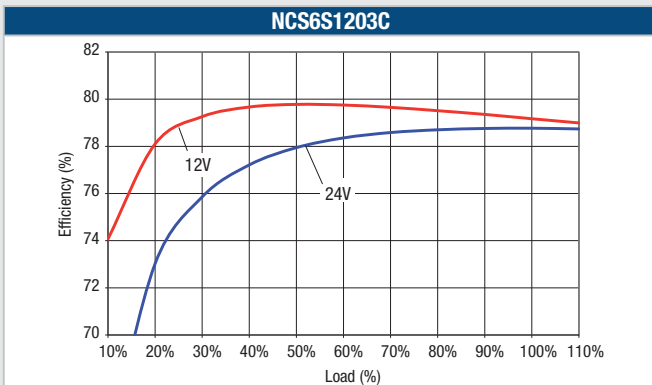

EFFICIENCY VS LOAD (Continued)

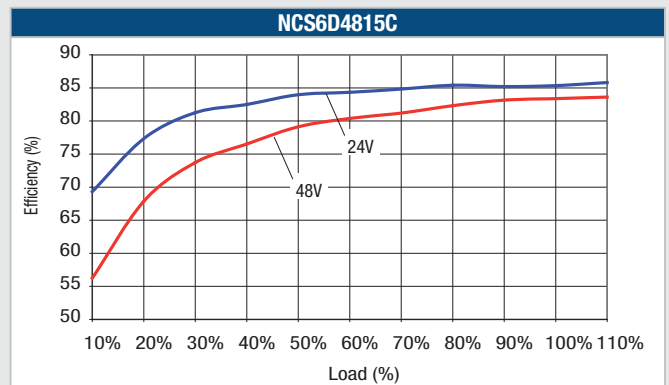
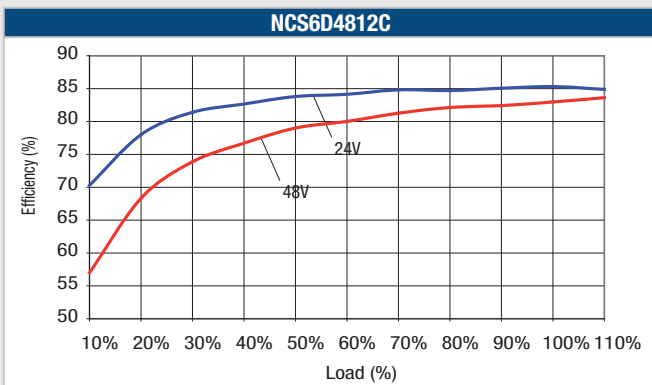
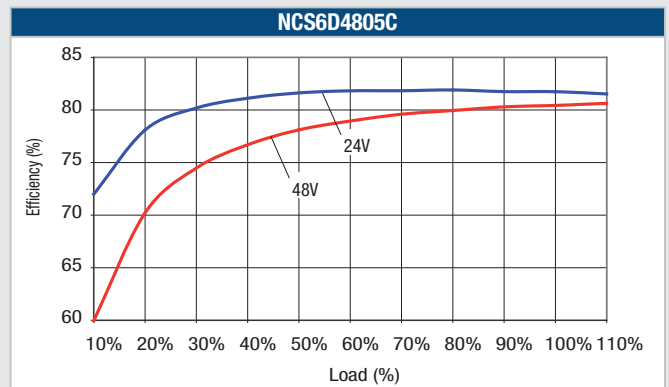
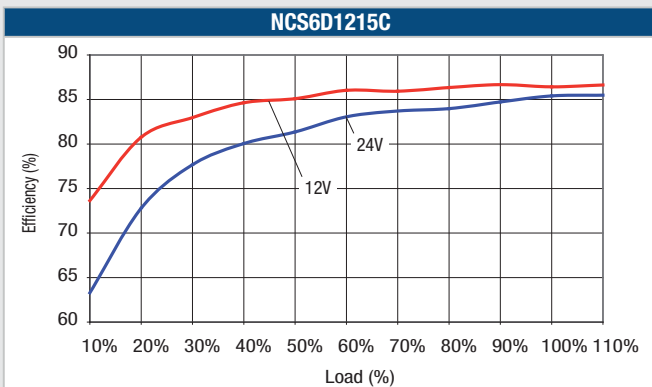
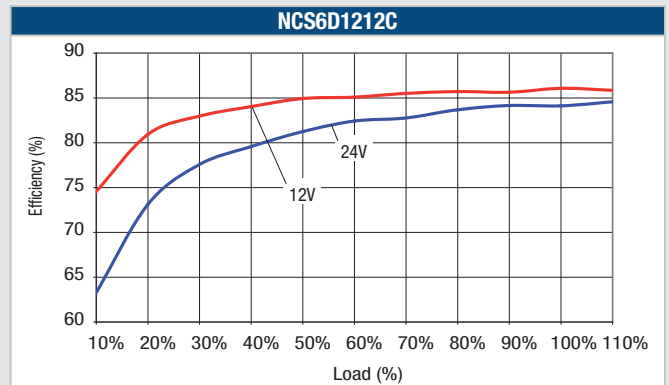
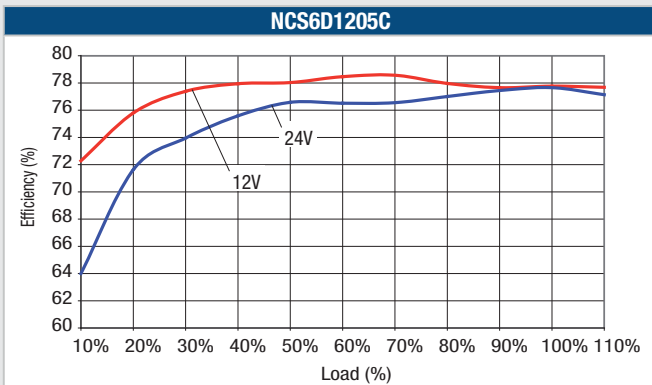

TEMPERATURE DERATING

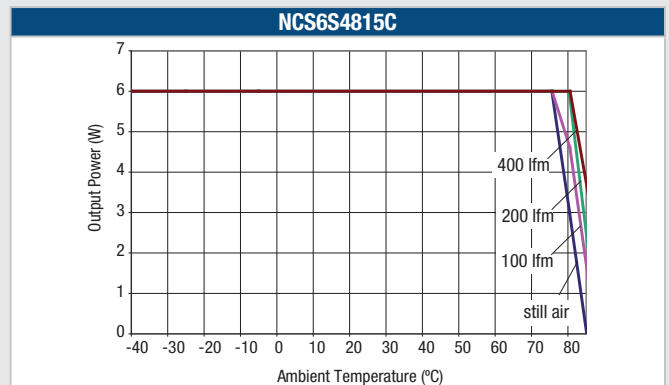
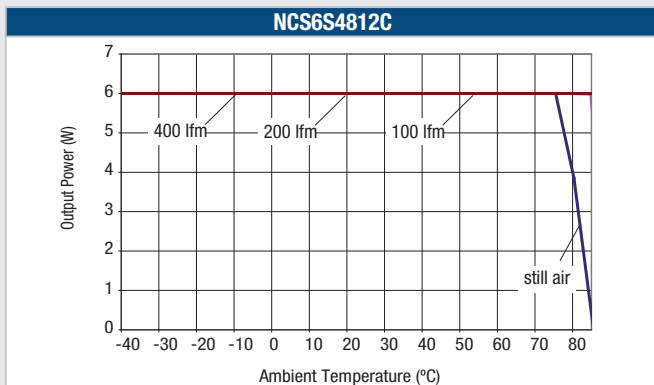
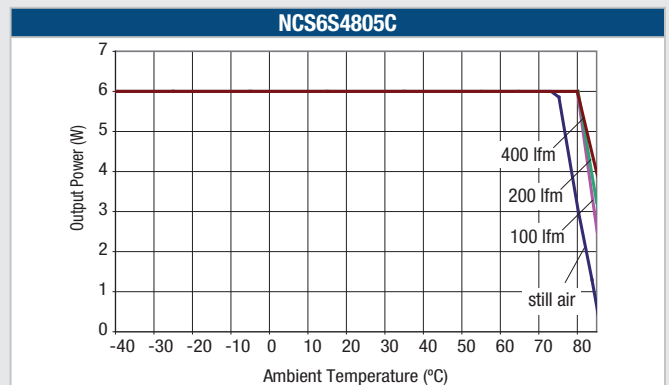
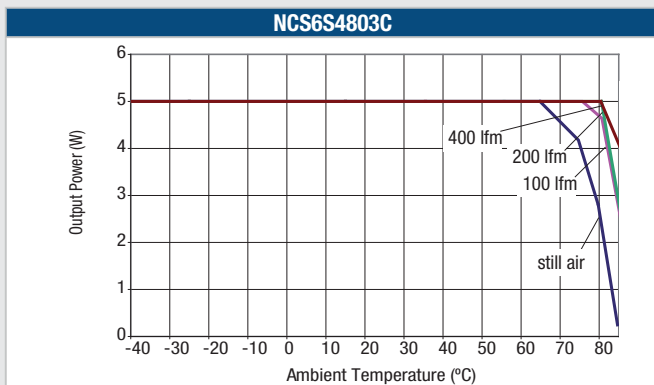
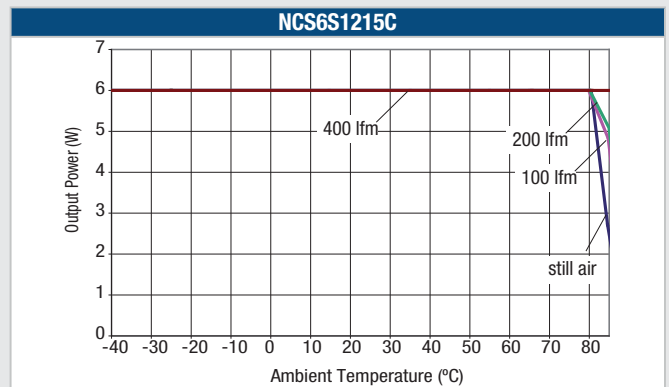
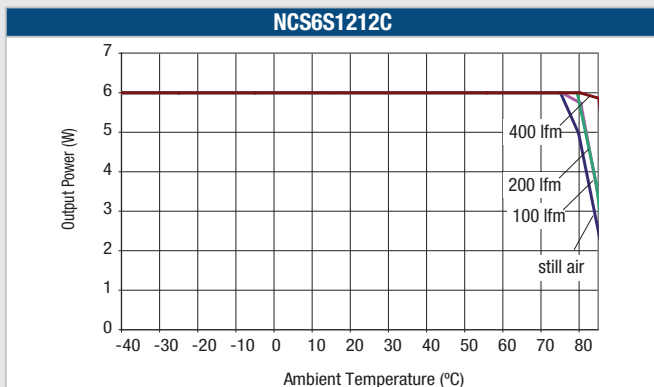
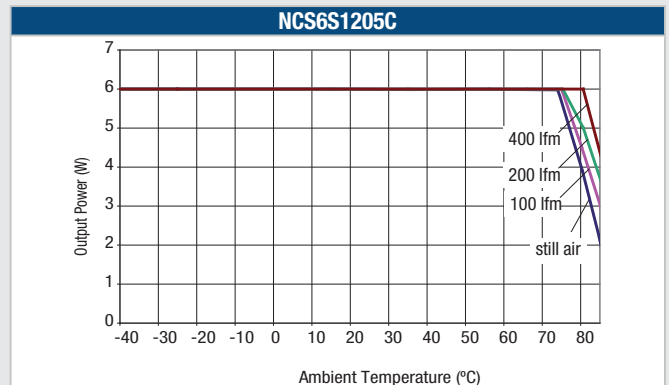
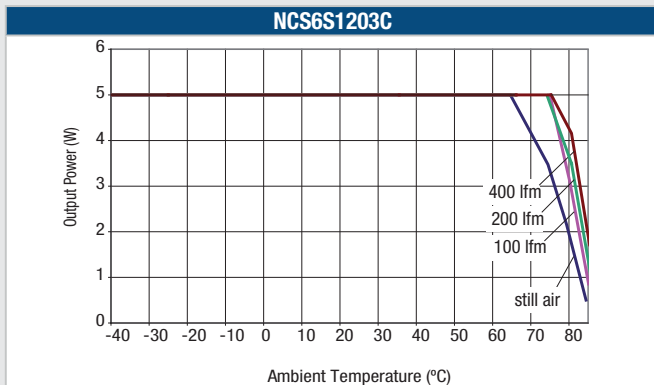

TEMPERATURE DERATING (Continued)

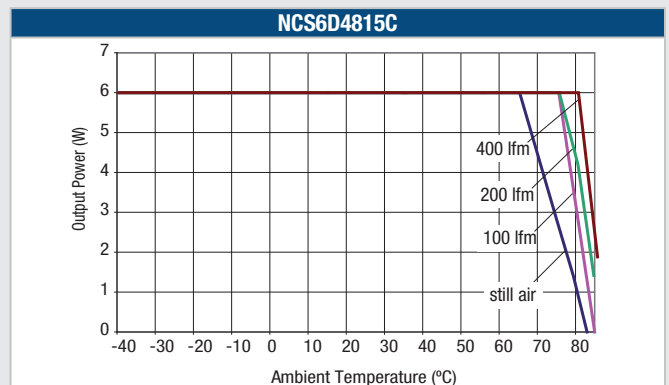
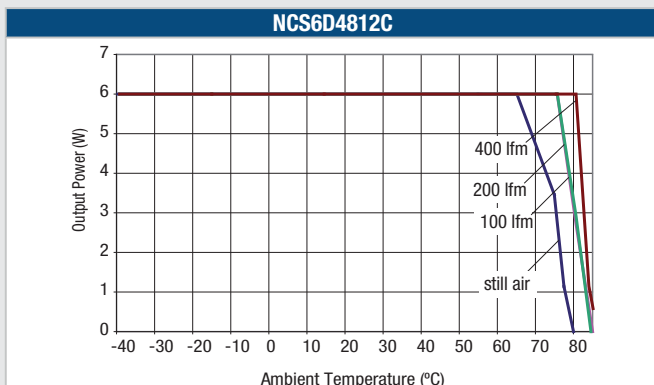
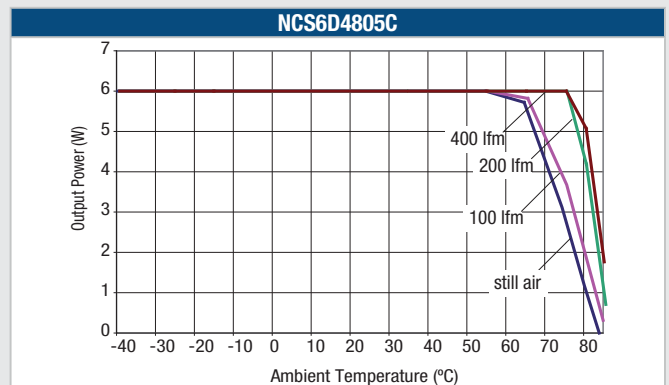
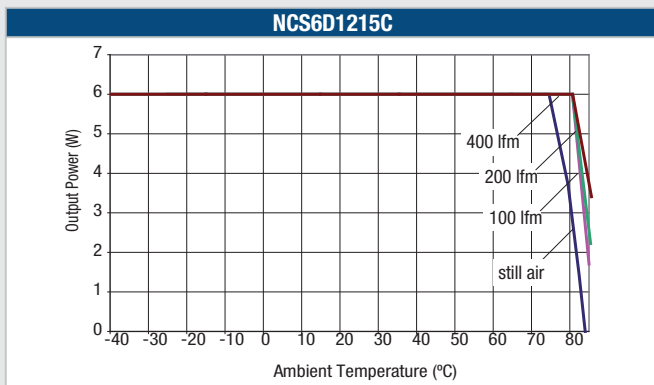
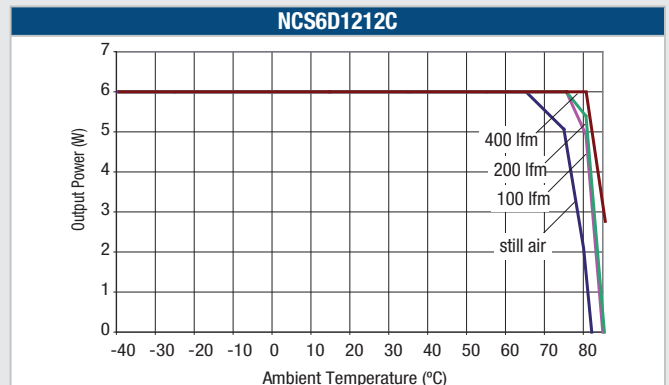
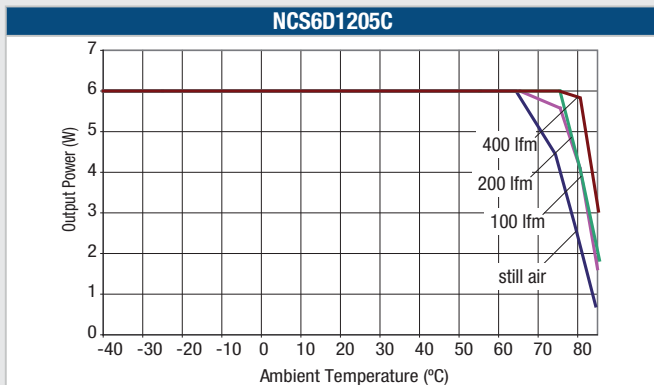

EMC FILTERING AND SPECTRA

FILTERING

The module includes a basic level of filtering, the following table shows the additional input capacitor typically required to meet EN 55022 Curve A Quasi-Peak EMC limit, as shown in the below plots.

NCS6D1205C	2.2 μ F	NCS6S1203C	4.7 μ F
NCS6D1212C	none	NCS6S1205C	4.7 μ F
NCS6D1215C	none	NCS6S1212C	10 μ F
NCS6D4805C	10 μ F	NCS6S1215C	10 μ F
NCS6D4812C	10 μ F	NCS6S4803C	4.7 μ F
NCS6D4815C	10 μ F	NCS6S4805C	10 μ F
		NCS6S4812C	10 μ F
		NCS6S4815C	10 μ F

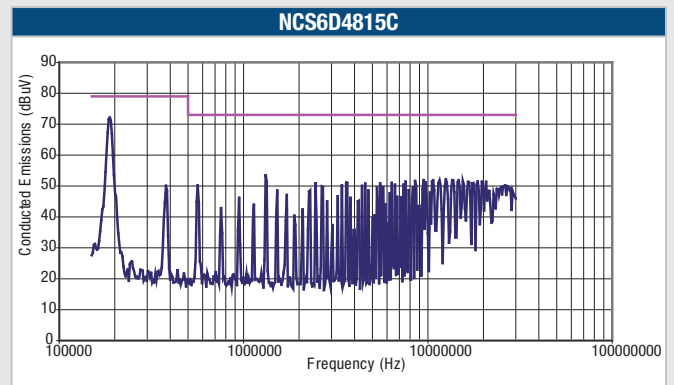
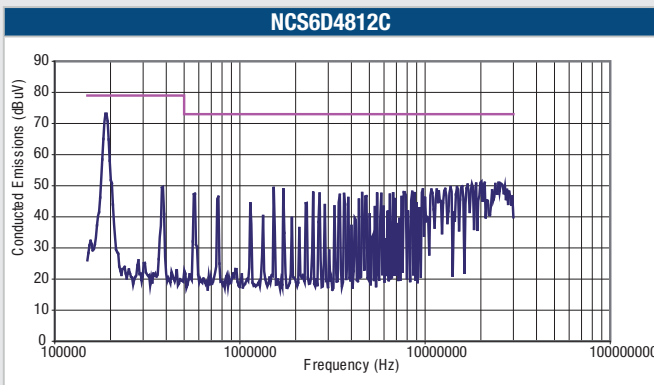
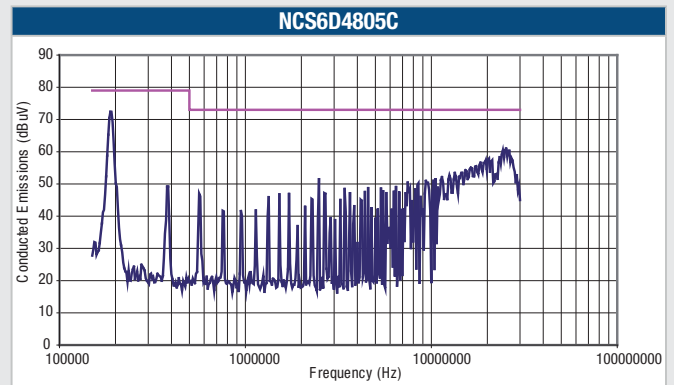
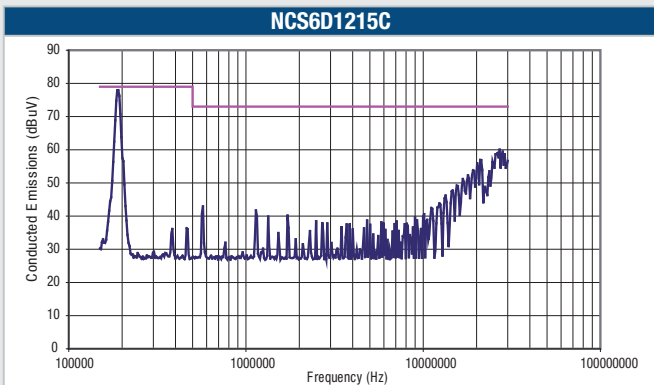
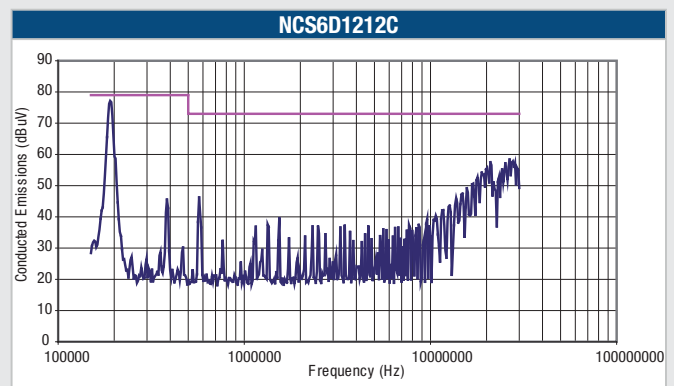
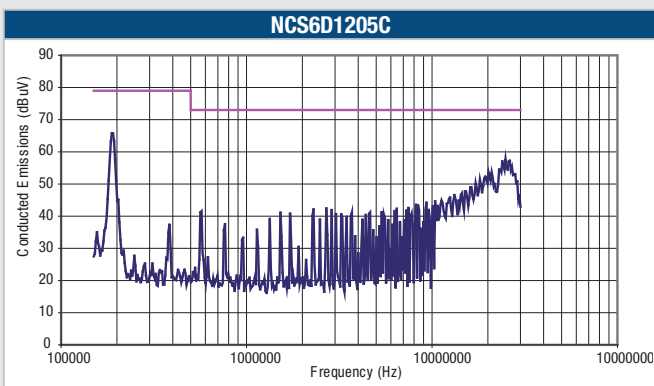

EMC FILTERING AND SPECTRA (Continued)

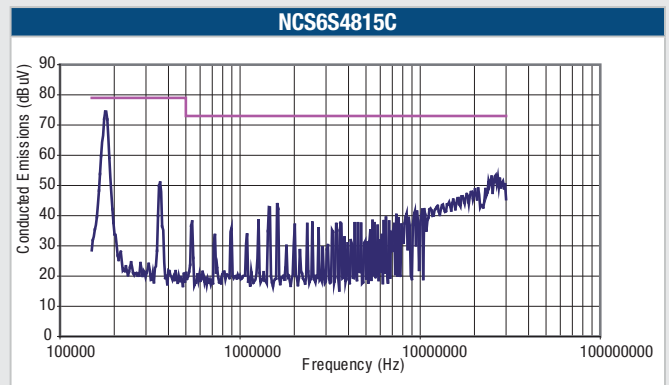
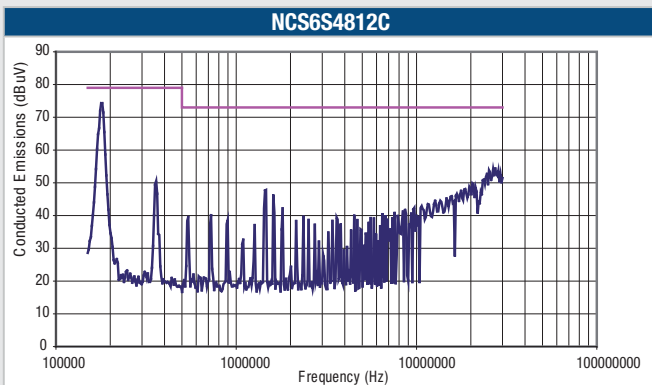
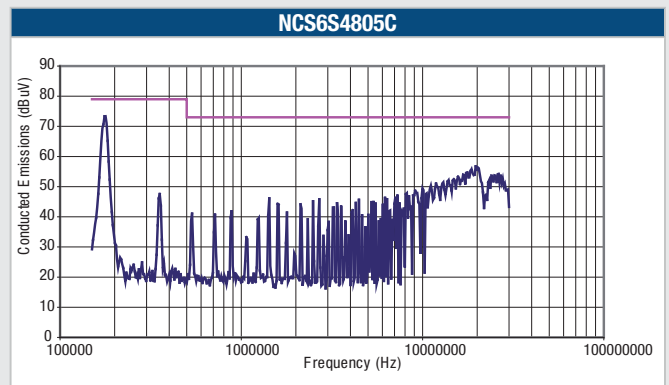
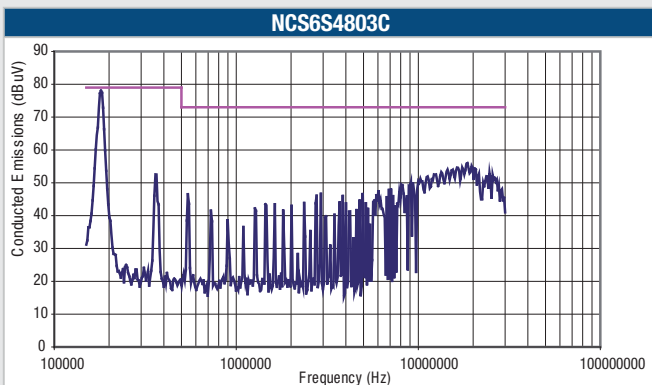
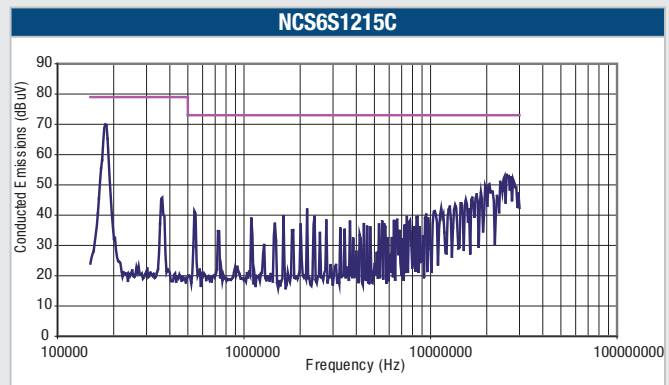
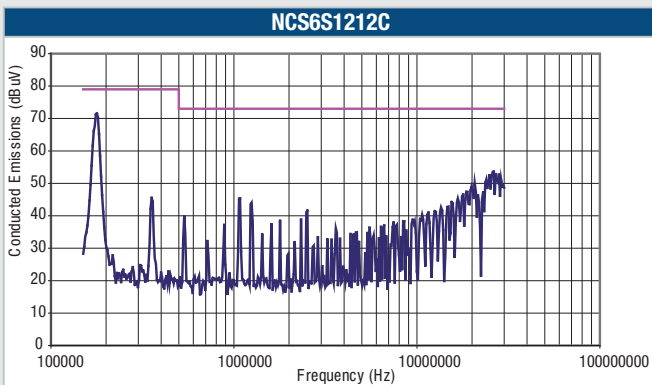
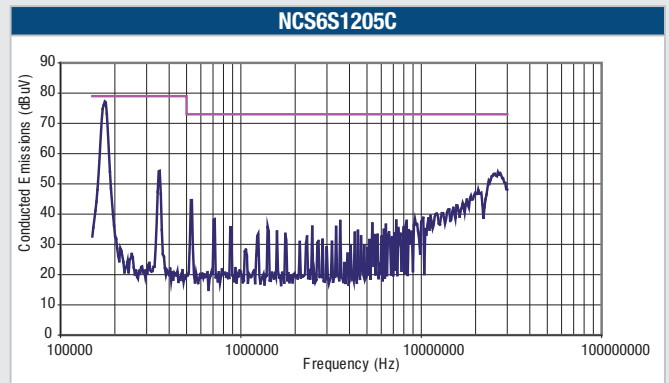
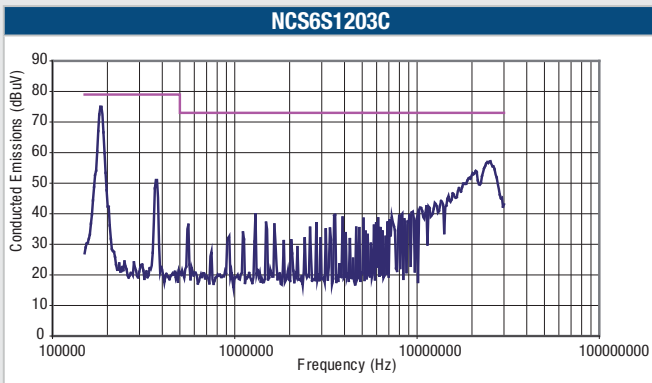

PACKAGE SPECIFICATIONS

MECHANICAL DIMENSIONS

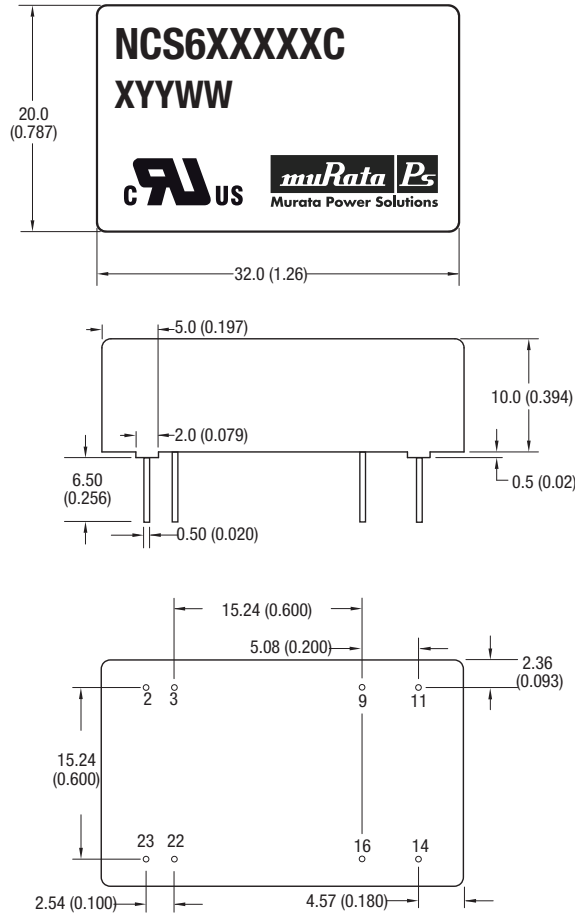

All dimensions in mm (inches) ± 0.5 (0.020) except pin to pin tolerance ± 0.25 (0.010). All pins on a 2.54 (0.100) pitch and within 0.25 (0.010) of true position.

Weight: 17g

The copper case is connected to pin 16. Care is needed in the design of this circuit board on which the converter is mounted. Top side tracks must not contact the edge of the case on the underside of the unit.

Please note that from 2010 onwards, you may receive either a blue or a black case.

PIN CONNECTIONS

Pin	Function	
	Single	Dual
2	-VIN	-VIN
3	-VIN	-VIN
9	No pin	OV
11	N/C	-VOUT
14	+VOUT	+VOUT
16	-VOUT	OV
22	+VIN	+VIN
23	+VIN	+VIN

TUBE OUTLINE DIMENSIONS

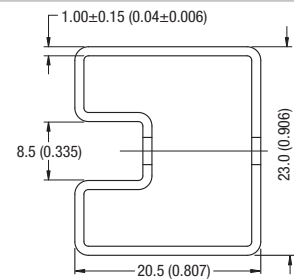

Tube length 520 (20.47)
All dimensions in mm (inches) ± 0.25 (0.010). Quantity: 15

RECOMMENDED FOOTPRINT DETAILS

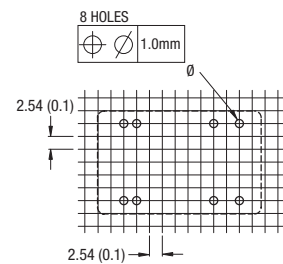

All dimensions in mm (inches) ± 0.25 (± 0.010).

DISCLAIMER

Unless otherwise stated in the datasheet, all products are designed for standard commercial and industrial applications and NOT for safety-critical and/or life-critical applications.

Particularly for safety-critical and/or life-critical applications, i.e. applications that may directly endanger or cause the loss of life, inflict bodily harm and/or loss or severe damage to equipment/property, and severely harm the environment, a prior explicit written approval from Murata is strictly required. Any use of Murata standard products for any safety-critical, life-critical or any related applications without any prior explicit written approval from Murata shall be deemed unauthorised use.

These applications include but are not limited to:

- Aircraft equipment
- Aerospace equipment
- Undersea equipment
- Power plant control equipment
- Medical equipment
- Transportation equipment (automobiles, trains, ships, etc.)
- Traffic signal equipment
- Disaster prevention / crime prevention equipment
- Data Processing equipment

Murata makes no express or implied warranty, representation, or guarantee of suitability, fitness for any particular use/purpose and/or compatibility with any application or device of the buyer, nor does Murata assume any liability whatsoever arising out of unauthorised use of any Murata product for the application of the buyer. The suitability, fitness for any particular use/purpose and/or compatibility of Murata product with any application or device of the buyer remain to be the responsibility and liability of the buyer.

Buyer represents and agrees that it has all the necessary expertise to create and implement safeguards that anticipate dangerous consequences of failures, monitor failures and their consequences, lessen the likelihood of failures that might cause harm, and take appropriate remedial actions. Buyer will fully indemnify and hold Murata, its affiliated companies, and its representatives harmless against any damages arising out of unauthorised use of any Murata products in any safety-critical and/or life-critical applications.

Remark: Murata in this section refers to Murata Manufacturing Company and its affiliated companies worldwide including, but not limited to, Murata Power Solutions.



This product is subject to the following [operating requirements](https://www.murata.com/en-eu/products/power/requirements) and the [Life and Safety Critical Application Sales Policy](https://www.murata.com/en-eu/products/power/requirements):

Refer to: <https://www.murata.com/en-eu/products/power/requirements>

Murata Power Solutions (Milton Keynes) Ltd. makes no representation that the use of its products in the circuits described herein, or the use of other technical information contained herein, will not infringe upon existing or future patent rights. The descriptions contained herein do not imply the granting of licenses to make, use, or sell equipment constructed in accordance therewith. Specifications are subject to change without notice. © 2020 Murata Power Solutions (Milton Keynes) Ltd.