

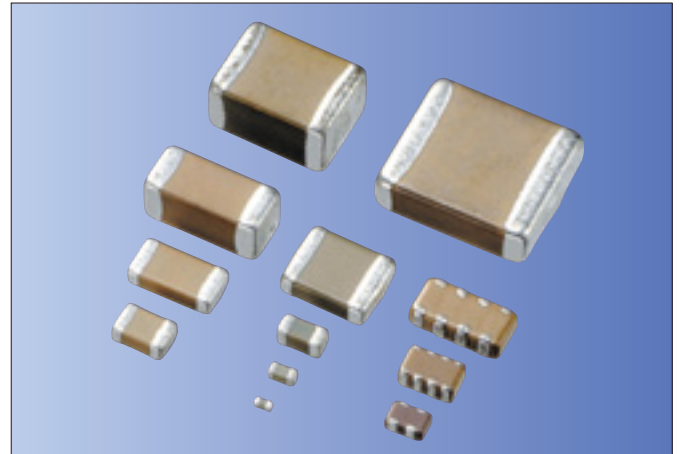

Kyocera's series of Multilayer Ceramic Chip Capacitors are designed to meet a wide variety of needs. We offer a complete range of products for both general and specialized applications, including CM series for general-purpose, CT series for low profile, CA series for arrays, CL series for ICs, CF series for high-voltage, and DM series for automotive.

## Features

- We have factories worldwide in order to supply our global customer bases quickly and efficiently and to maintain our reputation as one of the highest-volume producers in the industry.
- All our products are highly reliable due to their monolithic structure of high-purity and superfine uniform ceramics and their integral internal electrodes.
- By combining superior manufacturing technology and materials with high dielectric constants, we produce extremely compact components with exceptional specifications.
- Our stringent quality control in every phase of production from material procurement to shipping ensures consistent manufacturing and super quality.
- Kyocera components are available in a wide choice of dimensions, temperature characteristics, rated voltages, and terminations to meet specific configurational requirements.



RoHS Compliant

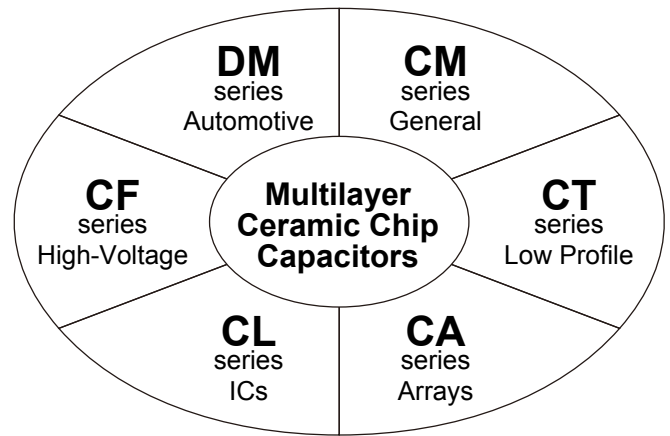

## Structure

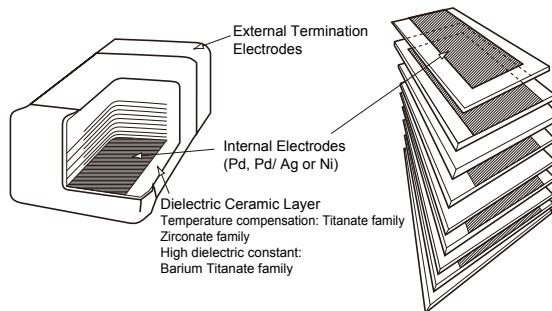

Nickel Barrier Termination Products

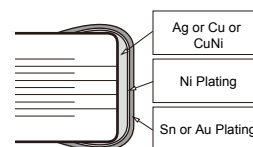

## Tape and Reel

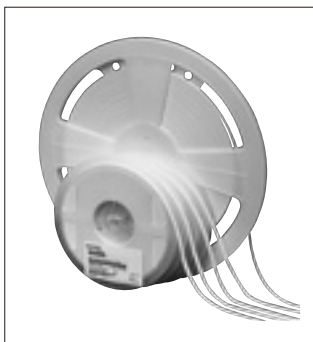

## Bulk Case

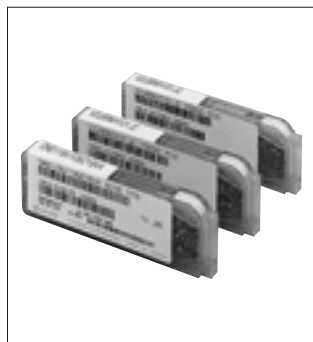

Please contact your local AVX, Kyocera sales office or distributor for specifications not covered in this catalog.

Our products are continually being improved. As a result, the capacitance range of each series is subject to change without notice. Please contact an sales representative to confirm compatibility with your application.



Kyocera Ceramic Chip Capacitors are available for different applications as classified below:

Series	Dielectric Options	Typical Applications	Features	Terminations	Available Size
<b>CM</b>	C0G (NP0) X5R X7R *X6S *X7S Y5V	General purpose	Wide cap range	Nickel barrier	01005, 0201, 0402 0603, 0805, 1206 1210, 1812
<b>CT</b>	X5R X7R Y5V	IC card (Decoupling)	Low profile	Nickel barrier	0201, 0402, 0603 0805, 1206, 1210
<b>CA</b>	C0G (NP0) X5R, X7R	Digital signal Pass line	Reduction in placing cost	Nickel barrier	0405, 0508
<b>CL</b>	X7S	ICs (Decoupling)	Low inductance	Nickel barrier	0204, 0306
<b>CF</b>	C0G (NP0) X7R	High voltage & Power circuits	High voltage 250VDC, 630VDC 1000VDC, 2000VDC 3000VDC, 4000VDC	Nickel barrier	0805, 1206, 1210 1812, 2208, 1808 2220
<b>DM</b>	X7R	Automotive	Thermal shock Resistivity High reliability	Nickel barrier	0603,0805,1206

\* Option

\* Negative temperature coefficient dielectric types are available on request.



## Dimensions

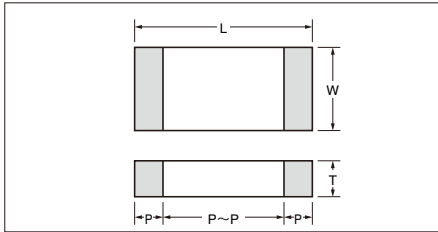

## Dimensions and Packaging Quantities

Size	Code		Dimension Code	Dimensions (mm)						Maximum quantity per reel							
	JIS	EIA		L	W	T	P min.	P max.	P to P min.	φ180 Reel	φ330 Reel						
02	0402	01005	A	0.4±0.02	0.2±0.02	0.2±0.02	0.07	0.14	0.13	40kp (E4/1) 20kp (P8/2)	-						
03	0603	0201	A	0.6±0.03	0.3±0.03	0.22 max.	0.10	0.20	0.20	30kp (P8/1) 15kp (P8/2)	50kp (P8/2)						
			B			0.3±0.03				30kp (P8/1) 15kp (P8/2)	50kp (P8/2)						
			C	0.6±0.05	0.3±0.05	0.3±0.05	0.13	0.23	0.19	30kp (P8/1) 15kp (P8/2)	50kp (P8/2)						
05	1005	0402	A	1.0±0.05	0.5±0.05	0.25 max.	0.15	0.35	0.30	20kp (P8/1) 10kp (P8/2)	50kp (P8/2)						
			B			0.35 max.				20kp (P8/1) 10kp (P8/2)	50kp (P8/2)						
			C			0.5±0.05				20kp (P8/1) 10kp (P8/2)	50kp (P8/2)						
			D	1.0±0.10	0.5±0.10	0.35 max.				20kp (P8/1) 10kp (P8/2)	50kp (P8/2)						
			E			0.5±0.10				20kp (P8/1) 10kp (P8/2)	50kp (P8/2)						
			F	1.0±0.15	0.5±0.15	0.5±0.15				20kp (P8/1) 10kp (P8/2)	50kp (P8/2)						
105	1608	0603	A	1.6±0.10	0.8±0.10	0.55 max.	0.20	0.60	0.50	20kp (P8/1) 10kp (P8/2)	50kp (P8/2)						
			B			0.8±0.10				4kp (P8/4) 8kp (P8/2) 4kp (P8/4)	10kp (P8/4) 20kp (P8/2) 10kp (P8/4)						
			C			0.55 max.				8kp (P8/2) 4kp (P8/4)	20kp (P8/2) 10kp (P8/4)						
			D	1.6±0.15	0.8±0.15	0.8±0.15				8kp (P8/2) 4kp (P8/4)	20kp (P8/2) 10kp (P8/4)						
			E			0.55 max.				8kp (P8/2) 4kp (P8/4)	20kp (P8/2) 10kp (P8/4)						
			F	1.6±0.2	0.8±0.2	0.8±0.2				8kp (P8/2) 4kp (P8/4)	20kp (P8/2) 10kp (P8/4)						
21	2012	0805	A	2.0±0.10	1.25±0.10	0.55 max.	0.20	0.75	0.70	4kp (P8/4)	10kp (P8/4)						
			B			0.95 max.				4kp (P8/4)	10kp (P8/4)						
			C			1.00 max.				4kp (E8/4)	10kp (E8/4)						
			D			0.6±0.10				4kp (P8/4)	10kp (P8/4)						
			E			0.85±0.10				4kp (P8/4)	10kp (P8/4)						
			F			1.05±0.10				3kp (E8/4)	10kp (E8/4)						
			G			1.25±0.10				3kp (E8/4)	10kp (E8/4)						
			H	2.0±0.15	1.25±0.15	0.55 max.				4kp (P8/4)	10kp (P8/4)						
			J			0.95 max.				4kp (P8/4)	10kp (P8/4)						
			K			1.25±0.15				3kp (E8/4)	10kp (E8/4)						
			L	2.0±0.20	1.25±0.20	0.95 max.				4kp (P8/4)	10kp (P8/4)						
			M			1.25±0.20				3kp (E8/4)	10kp (E8/4)						
			316	3216	1206	A				3.2±0.20	1.6±0.15	0.85±0.10	0.30	0.85	1.40	4kp (P8/4)	10kp (P8/4)
						B						0.95 max.				4kp (P8/4)	10kp (P8/4)
C	1.00 max.	4kp (E8/4)				10kp (E8/4)											
D	1.15±0.10	3kp (E8/4)				10kp (E8/4)											
E	1.25±0.10	3kp (E8/4)				10kp (E8/4)											
F	1.6±0.15	2.5kp (E8/4)				5kp (E8/4)											
G	3.2±0.20	1.6±0.20				0.95 max.	4kp (P8/4)	10kp (P8/4)									
H						1.00 max.	4kp (E8/4)	10kp (E8/4)									
J						1.6±0.20	2.5kp (E8/4)	5kp (E8/4)									
32	3225	1210				A	3.2±0.20	2.5±0.20	1.00 max.	0.30	1.00	1.40				4kp (E8/4)	10kp (E8/4)
			B	1.40 max.	3kp (E8/4)	10kp (E8/4)											
			C	1.60 max.	2.5kp (E8/4)	5kp (E8/4)											
			D	1.6±0.15	2.5kp (E8/4)	5kp (E8/4)											
			E	2.20 max.	2kp (E8/4)	5kp (E8/4)											
			F	2.0±0.2	2kp (E8/4)	5kp (E8/4)											
			G	2.5±0.2	1kp (E8/4)	4kp (E8/4)											
42	4520	1808	A	4.5±0.20	2.0±0.20	1.6 max.	0.15	0.85	2.60	2kp (E12/4)	-						
			B			2.2 max.				2kp (E12/4)	-						
43	4532	1812	A	4.5±0.30	3.2±0.20	2.0 max.	0.30	1.10	2.00	1kp (E12/8)	-						
			B			2.0±0.2				1kp (E12/8)	-						
			C			2.5 max.				0.5kp (E12/8)	-						
			D			2.5±0.2				0.5kp (E12/8)	-						
			E			2.8 max.				0.5kp (E12/8)	-						
			F			2.8±0.2				0.5kp (E12/8)	-						
52	5720	2208	A	5.7±0.40	2.0±0.20	2.2 max.	0.15	0.85	4.20	2kp (12/8)	-						
			B			2.0 max.				1kp (E12/8)	-						
55	5750	2220	A	5.7±0.40	5.0±0.40	2.5 max.	0.30	1.40	2.50	0.5kp (E12/8)	-						
			C			2.8 max.				0.5kp (E12/8)	-						

Note: Taping denotes the quantity packaged per reel (kp means 1000 pieces).

\* Please contact us.



### KYOCERA PART NUMBER

**CM 21 X7R 104 K 50 A T**

#### SERIES CODE

CM = General Purpose      CL = ICs  
 CT = Low Profile          CF = High Voltage  
 CA = Arrays                DM = Automotive

#### SIZE CODE

SIZE	EIA	(JIS)	SIZE	EIA	(JIS)	SIZE	EIA	(JIS)			
02	=	01005	(0402)	32	=	1210	(3225)	D11	=	0405	(1014)/ 2 cap
03	=	0201	(0603)	42	=	1808	(4520)	F12	=	0508	(1220)/ 4 cap
05	=	0402	(1005)	43	=	1812	(4532)				
105	=	0603	(1608)	52	=	2208	(5720)				
21	=	0805	(2012)	55	=	2220	(5750)				
316	=	1206	(3216)								

#### DIELECTRIC CODE

**CODE EIA CODE**  
 CG = C0G (NPO)            X7S = X7S (Option)  
 X5R = X5R                  X6S = X6S (Option)  
 X7R = X7R                  Y5V = Y5V

Negative temperature coefficient dielectric types are available on request.

#### CAPACITANCE CODE

Capacitance expressed in pF.  
 Two significant digits plus number of zeros.  
 For Values < 10pF, Letter R denotes decimal point,  
 eg. 10000pF = 104      1.5pF = 1R5  
 0.1μF = 104      0.5pF = R50  
 4700pF = 472      100μF = 107

#### TOLERANCE CODE

A = ±0.05pF (option)      D = ±0.5pF      J = ±5%      Z = -20 to +80%  
 B = ±0.1pF                F = ±1pF      K = ±10%  
 C = ±0.25pF                G = ±2% (option)      M = ±20%

#### VOLTAGE CODE

04 = 4VDC	100 = 100VDC	1000 = 1000VDC
06 = 6.3VDC	250 = 250VDC	2000 = 2000VDC
10 = 10VDC	400 = 400VDC	3000 = 3000VDC
16 = 16VDC	630 = 630VDC	4000 = 4000VDC
25 = 25VDC		
35 = 35VDC		
50 = 50VDC		

#### TERMINATION CODE

A = Nickel Barrier/ Tin      K = Nickel Barrier/ Au

#### PACKAGING CODE

B = Bulk	L = 13" Reel Taping & 4mm Cavity pitch
C = Bulk Cassette (option)	H = 7" Reel Taping & 2mm Cavity pitch
T = 7" Reel Taping & 4mm Cavity pitch	N = 13" Reel Taping & 2mm Cavity pitch
Q = 7" Reel Taping & 1mm Cavity pitch	*P = 7" Reel Taping & 1mm Cavity pitch
	* Carrier tape width 4mm.

#### OPTION

Thickness max. value is indicated in CT series

EX. 125 → 1.25mm max.  
 095 → 0.95mm max.



## Temperature Compensation Type

Dielectric Value (pF)	C0G (NPO) 0 ppm/ °C	UΔ (N750) -750 ppm/ °C	SL +350 to -1000ppm/ °C
0.5 to 2.7	CK	UK	SL
3.0 to 3.9	CJ	UJ	SL
4.0 to 9.0	CH	UJ	SL
≥10	CG	UJ	SL

K = ±250ppm/ °C, J = ±120ppm/ °C, H = ±60ppm/ °C, G = ±30ppm/ °C  
e.g. CG = 0±30ppm/ °C

Note: All parts of C0G will be marked as "CG" but will conform to the above table.

## High Dielectric Constant Type

EIA Dielectric	Temperature Range	ΔC max.
X5R	-55 to 85°C	±15%
X7R	-55 to 125°C	
*X7S	-55 to 125°C	±22%
*X6S	-55 to 105°C	
Y5V	-30 to 85°C	-82 to +22%

\* option

## Available Tolerances

Dielectric materials, capacitance values and tolerances are available in the following combinations only:

EIA Dielectric	Tolerance	Capacitance
C0G	C=±0.25pF D=±0.50pF	*1 <10pF
	*3 A=±0.05pF B=±0.1pF	<0.5pF ≤5pF
	*3 G=±2% J=±5% K=±10%	≥10pF E12 Series
	*3 X6S X5R *3 X7S X7R	*2 K=±10% M=±20%
Y5V	Z=-20% to +80%	E3 Series

Note:

\*1 Nominal values below 10pF are available in the standard values of 0.5pF, 1.0pF, 1.5pF, 2.0pF, 3.0pF, 4.0pF, 5.0pF, 6.0pF, 7.0pF, 8.0pF, 9.0pF

\*2 J = ±5% for X7R (X5R) is available on request.

\*3 option

\*4 E6 series is available on request.

## E Standard Number

E3	E6	E12	E24 (Option)		
1.0	1.0	1.0	1.0	1.1	
		1.2	1.2	1.3	
	1.5	1.5	1.5	1.6	
		1.8	1.8	2.0	
2.2	2.2	2.2	2.2	2.4	
		2.7	2.7	3.0	
	3.3	3.3	3.3	3.6	
		3.9	3.9	4.3	
	4.7	4.7	4.7	4.7	5.1
			5.6	5.6	6.2
6.8		6.8	6.8	7.5	
		8.2	8.2	9.1	

### Features

We offer a diverse product line ranging from ultra-compact (0.4×0.2mm) to large (4.5×3.2mm) components configured for a variety of temperature characteristics, rated voltages, and packages. We offer the choice and flexibility for almost any applications.

### Applications

This standard type is ideal for use in a wide range of applications, from commercial to industrial equipment.

### Temperature Compensation Dielectric

Size (EIA Code)	CM02 (01005)	CM03 (0201)					CM05 (0402)			CM105 (0603)		CM21 (0805)				
Temperature	CΔ*1	CΔ*1		UΔ*2		SL	CΔ*1	UΔ*2	SL	CΔ*1		CΔ*1				
Rated Voltage (VDC)	16	25	50	16	25	25	50	50	50	50	100	16	25	50	100	
Capacitance (pF)	16	25	50	16	25	25	50	50	50	50	100	16	25	50	100	
R20 0.2																
R50 0.5																
1R0 1.0																
1R5 1.5																
2.0																
3.0																
4.0																
5.0																
6.0																
7.0																
8.0																
9.0																
100 10																
120 12																
15 15																
18 18																
22 22																
27 27																
33 33																
39 39																
47 47																
56 56																
68 68																
82 82																
101 100																
121 120																
150 150																
180 180																
220 220																
270 270																
330 330																
390 390																
470 470																
560 560																
680 680																
820 820																
102 1000																
122 1200																
1500 1500																
1800 1800																
2200 2200																
2700 2700																
3300 3300																
3900 3900																
4700 4700																
5600 5600																
6800 6800																
8200 8200																
103 10000																
123 12000																
15000 15000																
18000 18000																

\* E24 series is available on request.

Optional Spec.

\*1: CG,CH,CJ,CK

\*2: UJ,UK

Alphabets in capacitance chart denote dimensions. Please refer to the below table for detail.

(Example)  
In case of "B" for CM03;  
L : 0.6±0.03mm  
W : 0.3±0.03mm  
T : 0.3±0.03mm

Size	Size Code	Dimension (mm)		
		L	W	T
02	A	0.4±0.02	0.2±0.02	0.2±0.02
03	B	0.6±0.03	0.3±0.03	0.3±0.03
05	C	1.0±0.05	0.5±0.05	0.5±0.05
105	B	1.6±0.10	0.8±0.10	0.8±0.10
21	D	2.0±0.10	1.25±0.10	0.6±0.10
	E			0.85±0.10
	G			1.25±0.10

### X5R Dielectric

Size (EIA Code)	CM02 (01005)		CM03 (0201)				CM05 (0402)					CM105 (0603)					CM21 (0805)								
	Rated Voltage (VDC)	Capacitance (pF)	6.3	10	16	25	4	6.3	10	16	25	50	4	6.3	10	16	25	50	4	6.3	10	16	25	50	
101	100																								
151	150																								
	220																								
	330																								
	470																								
102	680																								
152	1000																								
	1500																								
	2200																								
	3300																								
103	4700																								
	6800																								
	10000																								
153	15000																								
	22000																								
	33000																								
	47000																								
104	68000																								
	100000																								
105	220000																								
	470000																								
	1000000																								
106	2200000																								
	4700000																								
	10000000																								
107	22000000																								
	47000000																								
	100000000																								

Size (EIA Code)	CM316 (1206)					CM32 (1210)					CM43 (1812)					
	Rated Voltage (VDC)	Capacitance (pF)	6.3	10	16	25	50	100	4	6.3	10	16	25	50	6.3	50
105	220000															
	470000															
	1000000															
106	2200000															
	4700000															
	10000000															
107	22000000															
	47000000															
	100000000															

- E6 series is standard.
- E3 series is standard for the size 316 and larger.
- E12 series is available on request.
- ▨ Optional Spec.

Two digits alphanumeric in capacitance chart denote dimensions and tan δ. Please refer to the below table for detail.

(Example)  
In case of "B2" for CM03:  
L : 0.6±0.03mm  
W : 0.3±0.03mm  
T : 0.3±0.03mm  
Tan δ : 3.5% max.

Size	Size Code	Dimension (mm)		
		L	W	T
02	A	0.4±0.02	0.2±0.02	0.2±0.02
	B	0.6±0.03	0.3±0.03	0.3±0.03
03	C	0.6±0.05	0.3±0.05	0.3±0.05
	D	1.0±0.05	0.5±0.05	0.5±0.05
05	E	1.0±0.10	0.5±0.10	0.5±0.10
	F	1.0±0.15	0.5±0.15	0.5±0.15
	G	1.6±0.10	0.8±0.10	0.8±0.10
105	H	1.6±0.15	0.8±0.15	0.8±0.15
	I	2.0±0.10	1.25±0.10	0.6±0.10
21	J	2.0±0.10	1.25±0.10	0.85±0.10
	K	2.0±0.10	1.25±0.10	1.25±0.10
	L	2.0±0.15	1.25±0.15	1.25±0.15
	M	2.0±0.20	1.25±0.20	1.25±0.20

Size	Size Code	Dimension (mm)		
		L	W	T
316	D	3.2±0.20	1.6±0.15	1.15±0.10
	F	3.2±0.20	1.6±0.15	1.6±0.15
	J	3.2±0.20	1.6±0.20	1.6±0.20
	K	3.2±0.20	1.6±0.20	1.6±0.20
32	B	3.2±0.20	2.5±0.20	1.40 max.
	C	3.2±0.20	2.5±0.20	1.60 max.
	F	3.2±0.20	2.5±0.20	2.0±0.2
	G	3.2±0.20	2.5±0.20	2.5±0.2
43	D	4.5±0.30	3.2±0.20	2.5±0.2
	F	4.5±0.30	3.2±0.20	2.8±0.2

Tan δ Code	Tan δ
1	2.5% max.
2	3.5% max.
3	5.0% max.
4	7.0% max.
5	7.5% max.
7	10.0% max.
8	12.5% max.
9	20.0% max.

### X7R Dielectric

Size (EIA Code)	CM02 (01005)	CM03 (0201)			CM05 (0402)			CM105 (0603)						CM21 (0805)					
Rated Voltage (VDC)	10	10	16	25	16	25	50	6.3	10	16	25	50	100	6.3	10	16	25	50	100
Capacitance (pF)	A8		B2	B2			C1												
101 100																			
151 150																			
220																			
330																			
470																			
680																			
102 1000																			
152 1500																			
2200																			
3300																			
4700																			
6800																			
103 10000																			
153 15000																			
22000																			
33000																			
47000																			
68000																			
104 100000																			
220000																			
470000																			
680000																			
105 1000000																			
2200000																			
4700000																			
106 10000000																			
22000000																			

Size (EIA Code)	CM316 (1206)						CM32 (1210)					CM43 (1812)	
Rated Voltage (VDC)	6.3	10	16	25	50	100	10	16	25	50	100	50	100
Capacitance (pF)													
104 47000													
100000													
220000													
470000													
105 1000000													
2200000													
4700000													
106 10000000													
22000000													

Optional Spec.

Two digits alphanumeric in capacitance chart denote dimensions and tan  $\delta$ . Please refer to the below table for detail.

(Example)  
 In case of "B3" for CM03:  
 L : 0.6±0.03mm  
 W : 0.3±0.03mm  
 T : 0.3±0.03mm  
 Tan  $\delta$  : 5.0% max.

Size	Size Code	Dimension (mm)		
		L	W	T
02	A	0.4±0.02	0.2±0.02	0.2±0.02
	B	0.6±0.03	0.3±0.03	0.3±0.03
	C	1.0±0.05	0.5±0.05	0.5±0.05
105	B	1.6±0.10	0.8±0.10	0.8±0.10
	D	1.6±0.15	0.8±0.15	0.8±0.15
21	D			0.6±0.10
	E	2.0±0.10	1.25±0.10	0.85±0.10
	G			1.25±0.10
	M	2.0±0.20	1.25±0.20	1.25±0.20
316	A			0.85±0.10
	D	3.2±0.20	1.6±0.15	1.15±0.10
	F			1.6±0.15
	J	3.2±0.20	1.6±0.20	1.6±0.20
32	B			1.40 max.
	F	3.2±0.20	2.5±0.20	2.0±0.2
	G			2.5±0.2
43	B	4.5±0.30	3.2±0.20	2.0±0.2
	D			2.5±0.2

Tan $\delta$ Code	Tan $\delta$
1	2.5% max.
2	3.5% max.
3	5.0% max.
5	7.5% max.
8	12.5% max.



**Y5V Dielectric**

Size (EIA Code)	CM05 (0402)				CM105 (0603)				CM21 (0805)				CM316 (1206)			CM32 (1210)			
	10	16	25	50	10	16	25	50	10	16	25	50	10	16	25	10	16	25	
Rated Voltage (VDC) Capacitance (pF)																			
102 1000 2200 472 4700																			
103 10000 22000 473 47000			C3	C3				B3											
104 100000 220000 474 470000	C8	C6					B3 B4					D3 E3 G3	E3 G3						
105 1000000 2200000 475 4700000					B8	B6										D6	D4		
106 10000000 22000000 476 47000000											G8 G9	G6				F8 F9	F6		F8 C6 C6

Two digits alphanumeric in capacitance chart denote dimensions and tan  $\delta$ .  
Please refer to the below table for detail.

(Example)  
In case of "C8" for CM05;  
L : 1.0±0.05mm  
W : 0.5±0.05mm  
T : 0.5±0.05mm  
Tan  $\delta$  : 12.5% max.

Size	Size Code	Dimension (mm)		
		L	W	T
05	C	1.0±0.05	0.5±0.05	0.5±0.05
105	B	1.6±0.10	0.8±0.10	0.8±0.10
	D	2.0±0.10	1.25±0.10	0.6±0.10
	E	2.0±0.10	1.25±0.10	0.85±0.10
21	G	2.0±0.10	1.25±0.10	1.25±0.10
	D	3.2±0.20	1.6±0.15	1.15±0.10
	F	3.2±0.20	1.6±0.15	1.6±0.15
316	C	3.2±0.20	2.5±0.20	1.60 max.
	F	3.2±0.20	2.5±0.20	2.0±0.2

Tan $\delta$ Code	Tan $\delta$
3	5.0% max.
4	7.0% max.
6	9.0% max.
8	12.5% max.
9	16.0% max.



**Test Conditions and Specifications for Temperature Compensation Type (CΔ to UΔ • SL Characteristics)  
CM/ CT/ CF Series**

Test Items		Test Conditions	Specifications								
Capacitance Value (C)		<table border="1"> <thead> <tr> <th>Capacitance</th> <th>Frequency</th> <th>Volt</th> </tr> </thead> <tbody> <tr> <td>C≤1000pF</td> <td>1MHz±10%</td> <td rowspan="2">0.5 to 5Vrms</td> </tr> <tr> <td>C&gt;1000pF</td> <td>1kHz±10%</td> </tr> </tbody> </table>	Capacitance	Frequency	Volt	C≤1000pF	1MHz±10%	0.5 to 5Vrms	C>1000pF	1kHz±10%	Within tolerance
Capacitance	Frequency	Volt									
C≤1000pF	1MHz±10%	0.5 to 5Vrms									
C>1000pF	1kHz±10%										
Q			C≥30pF : Q≥1000 C<30pF : Q≥400+20C								
Insulation Resistance (IR)		Measured after the rated voltage is applied for 1 minute at room ambient. For the rated voltage of over 630V, apply 500V for 1 minute at room ambient. The charge and discharge current of the capacitor must not exceed 50mA.	Over 10000MΩ or 500MΩ • μF, whichever is less								
Dielectric Resistance		Apply 3 times of the rated voltage for 1 to 5 seconds. Apply 1.5 times when the rated voltage is 250V or over. Apply 1.2 times when the rated voltage is 630V or over. The charge and discharge current of the capacitor must not exceed 50mA.	No problem observed								
Appearance		Microscope (10× magnification)	No problem observed								
Termination Strength		Apply a sideward force of 500g (5N) to a PCB-mounted sample. Apply 2N for 0201, and 1N for 01005 size.	No problem observed								
Bending Strength		Glass epoxy PCB: Fulcrum spacing: 90mm, duration time 10 seconds.	No significant damage at 1mm bent								
Vibration Test	Appearance	Vibration frequency: 10 to 55 (Hz) Amplitude: 1.5mm Sweeping condition: 10→55→10Hz/ 1 minute in X, Y and Z Directions: 2 hours each, 6 hours total.	No problem observed								
	ΔC		Within Tolerance								
	Q		C≥30pF : Q≥1000 C<30pF : Q≥400+20C								
Soldering Heat Resistance	Appearance	Soak the sample in 260°C±5°C solder for 10±0.5 seconds and place in room ambient, and measure after 24±2 hours. (Pre-heating conditions)	No problem observed								
	ΔC		Within ±2.5% or ±0.25pF, whichever is larger								
	Q		C≥30pF : Q≥1000 C<30pF : Q≥400+20C								
	IR		Over 10000MΩ or 500MΩ • μF whichever is less								
	Withstanding Voltage		Resist without problem								
Solderability	Soaking condition		Solder coverage : 90% min.								
		<table border="1"> <thead> <tr> <th>Order</th> <th>Temperature</th> <th>Time</th> </tr> </thead> <tbody> <tr> <td>1</td> <td>80 to 100°C</td> <td>2 minutes</td> </tr> <tr> <td>2</td> <td>150 to 200°C</td> <td>2 minutes</td> </tr> </tbody> </table>		Order	Temperature	Time	1	80 to 100°C	2 minutes	2	150 to 200°C
Order	Temperature	Time									
1	80 to 100°C	2 minutes									
2	150 to 200°C	2 minutes									
Temperature Cycle	Appearance	(Cycle)	No problem observed								
	ΔC	Room temperature (3min.)→	Within ±2.5% or ±0.25pF, whichever is larger								
	Q	Lowest operation temperature (30min.)→ Room temperature (3min.)→	C≥30pF : Q≥1000 C<30pF : Q≥400+20C								
	IR	Highest operation temperature(30min.)	Over 10000MΩ or 500MΩ • μF, whichever is less								
	Withstanding Voltage	After 5 cycles, measure after 24±2 hours. The charge and discharge current of the capacitor must not exceed 50mA for IR and withstanding voltage measurement.	Resist without problem								
Load Humidity Test (Except CF Series)	Appearance	After applying rated voltage for 500+12/-0 hours in pre-condition at 40°C±2°C, humidity 90 to 95%RH, allow parts to stabilize for 24±2 hours, at room temperature before measurement. The charge and discharge current of the capacitor must not exceed 50mA for IR measurement.	No problem observed								
	ΔC		Within ±7.5% or ±0.75pF, whichever is larger								
	Q		C≥30pF : Q≥200 C<30pF : Q≥100+10C/ 3								
	IR		Over 500MΩ or 25MΩ • μF, whichever is less								
High-Temperature with Loading	Appearance	After applying twice the rated voltage at the temperature of 125±3°C for 1000+12/-0 hours, measure the sample after 24±2 hours. Apply 1.5 times when the rated voltage is 250V or over. Apply 1.2 times when the rated voltage is 630V or over. The charge and discharge current of the capacitor must not exceed 50mA for IR measurement.	No problem observed.								
	ΔC		Within ±3% or ±0.3pF, whichever is larger								
	Q		C≥30pF : Q≥350 10pF<C<30pF : Q≥275+5C/ 2 C<10pF : Q≥200+10C								
	IR		Over 1000MΩ or 50MΩ • μF, whichever is less								

Please ask for individual specification for the hatched range in previous chart.



**Test Conditions and Specifications for High Dielectric Type (X5R, X7R)  
CM/ CT/ CA Series**

Test Items		Test Conditions	Specifications												
Capacitance Value (C)		Measure after heat treatment	Within tolerance												
Tanδ (%)		<table border="1"> <thead> <tr> <th>Capacitance</th> <th>Frequency</th> <th>Volt</th> </tr> </thead> <tbody> <tr> <td>C≤10μF</td> <td>1kHz±10%</td> <td>1.0±0.2Vrms</td> </tr> <tr> <td>C&gt;10μF</td> <td>120Hz±10%</td> <td>0.5±0.2Vrms</td> </tr> </tbody> </table>	Capacitance	Frequency	Volt	C≤10μF	1kHz±10%	1.0±0.2Vrms	C>10μF	120Hz±10%	0.5±0.2Vrms	Refer to capacitance chart			
Capacitance	Frequency	Volt													
C≤10μF	1kHz±10%	1.0±0.2Vrms													
C>10μF	120Hz±10%	0.5±0.2Vrms													
Insulation Resistance (IR)		Measured after the rated voltage is applied for 1 minute at room ambient. The charge and discharge current of the capacitor must not exceed 50mA.	Over 10000MΩ or 500MΩ • μF, whichever is less												
Dielectric Resistance		Apply 2.5 times of the rated voltage for 1 to 5 seconds. The charge and discharge current of the capacitor must not exceed 50mA.	No problem observed												
Appearance		Microscope (10× magnification)	No problem observed												
Termination Strength		Apply a sideward force of 500g (5N) to a PCB-mounted sample. note : 2N for 0201 size in for 01005 size. Exclude CT series with thickness of less than 0.66mm.	No problem observed												
Bending Strength		Glass epoxy PCB: Fulcrum spacing: 90mm, duration time 10 seconds. Exclude CT series with thickness of less than 0.66mm.	No significant damage at 1mm bent												
Vibration Test	Appearance	Take the initial value after heat treatment. Vibration frequency: 10 to 55 (Hz) Amplitude: 1.5mm Sweeping condition: 10→55→10Hz/ 1 minute in X, Y and Z Directions: 2 hours each, 6 hours total.	No problem observed												
	ΔC		Within tolerance												
	Tanδ (%)		Within tolerance												
Soldering Heat Resistance	Appearance	Take the initial value after heat treatment. Soak the sample in 260°C±5°C solder for 10±0.5 seconds and place in room ambient, and measure after 24±2 hours. (Pre-heating conditions)	No problem observed												
	ΔC		Within ±7.5%												
	Tanδ (%)		Within tolerance												
	IR		Over 10000MΩ or 500MΩ • μF, whichever is less												
	Withstanding Voltage	<table border="1"> <thead> <tr> <th>Order</th> <th>Temperature</th> <th>Time</th> </tr> </thead> <tbody> <tr> <td>1</td> <td>80 to 100°C</td> <td>2 minutes</td> </tr> <tr> <td>2</td> <td>150 to 200°C</td> <td>2 minutes</td> </tr> </tbody> </table>	Order	Temperature	Time	1	80 to 100°C	2 minutes	2	150 to 200°C	2 minutes	Resist without problem			
Order	Temperature	Time													
1	80 to 100°C	2 minutes													
2	150 to 200°C	2 minutes													
Solderability		Soaking condition	Solder coverage : 90% min.												
		<table border="1"> <thead> <tr> <th>Sn63 Solder</th> <th>Temperature</th> <th>Time</th> </tr> </thead> <tbody> <tr> <td></td> <td>235±5°C</td> <td>2±0.5 sec.</td> </tr> <tr> <th>Sn-3Ag-0.5Cu</th> <th>Temperature</th> <th>Time</th> </tr> <tr> <td></td> <td>245±5°C</td> <td>3±0.5 sec.</td> </tr> </tbody> </table>	Sn63 Solder	Temperature	Time		235±5°C	2±0.5 sec.	Sn-3Ag-0.5Cu	Temperature	Time		245±5°C	3±0.5 sec.	
Sn63 Solder	Temperature	Time													
	235±5°C	2±0.5 sec.													
Sn-3Ag-0.5Cu	Temperature	Time													
	245±5°C	3±0.5 sec.													
Temperature Cycle	Appearance	Take the initial value after heat treatment. (Cycle) Room temperature (3min.)→ Lowest operation temperature (30min.)→ Room temperature (3min.)→ Highest operation temperature(30min.) After 5 cycles, measure after 24±2 hours. The charge and discharge current of the capacitor must not exceed 50mA for IR and withstanding voltage measurement.	No problem observed												
	ΔC		Within ±7.5%												
	Tanδ (%)		Within tolerance												
	IR		Over 10000MΩ or 500MΩ • μF, whichever is less												
	Withstanding Voltage		Resist without problem												
Load Humidity Test	Appearance	Take the initial value after voltage treatment. After applying rated voltage for 500+12/ -0 hours in pre-condition at 40°C±2°C, humidity 90 to 95%RH, allow parts to stabilize for 24±2 hours, at room temperature before measurement. The charge and discharge current of the capacitor must not exceed 50mA for IR measurement.	No problem observed												
	ΔC		Within ±12.5%												
	Tanδ (%)		200% max. of initial value												
	IR		Over 500MΩ or 25MΩ • μF, whichever is less												
High-Temperature with Loading	Appearance	Take the initial value after voltage treatment. After applying twice the rated voltage at the highest operation temperature for 1000+12/ -0 hours, measure the sample after 24±2 hours. The charge and discharge current of the capacitor must not exceed 50mA for IR measurement. Apply 1.5 times when the rated voltage is 10V or less. Applied voltages for respective products are indicated in the below chart.	No problem observed												
	ΔC		Within ±12.5%												
	Tanδ (%)		200% max. of initial value												
	IR		Over 1000MΩ or 50MΩ • μF, whichever is less												

Pre-treatment	Heat	Keep specimen at 150+0/ -10°C for 1 hour, leave specimen at room ambient for 24±2 hours.
	Voltage	Apply the same test condition for 1 hour, then leave the specimen at room ambient for 24±2 hours.

High-temperature with Loading Applied Voltage (Rated Voltage × □ )

Applied Voltage	Rated Voltage	Products
×1.3	4V	CT03X5R104
	6.3V	CM105X5R475, CM316X5R476 CT05X5R104, CT21X5R106, CT03X5R104
×1.5	16V	CM105X7R474-105, CM21X7R105-475, CM316X7R475-106, CM32X7R106-226, CM05X5R224, CM105X5R225, CM21X5R475-106, CM316X5R226 CT105X5R105, CT21X5R225-475, CT316X5R106
	25V	CM105X7R474, CM21X7R105-225, CM316X7R475, CM32X7R106, CM105X5R474-105, CM21X5R225-106, CM316X5R106, CM32X5R106-226 CT316X5R225-106
	50V	CM21X5R105 CT21X5R225, CT316X5R105-475
	100V	CM32X7RK74, CM43X7R105

Please ask for individual specification for the hatched range in previous chart.



**Test Conditions and Specifications for High Dielectric Type (Y5V)  
CM/ CT/ CA Series**

Test Items		Test Conditions	Specifications									
Capacitance Value (C)		Measure after heat treatment	Within tolerance									
Tanδ (%)		<table border="1"> <thead> <tr> <th>Frequency</th> <th>Volt</th> </tr> </thead> <tbody> <tr> <td>1kHz±10%</td> <td>1.0±0.2Vrms</td> </tr> </tbody> </table>	Frequency	Volt	1kHz±10%	1.0±0.2Vrms	Refer to capacitance chart					
Frequency	Volt											
1kHz±10%	1.0±0.2Vrms											
Insulation Resistance (IR)		Measured after the rated voltage is applied for 1 minute at room ambient.	Over 10000MΩ or 500MΩ • μF, whichever is less									
Dielectric Resistance		Apply 2.5 times of the rated voltage for 1 to 5 seconds. The charge and discharge current of the capacitor must not exceed 50mA.	No problem observed									
Appearance		Microscope (10× magnification)	No problem observed									
Termination Strength		Apply a sideward force of 500g (5N) to a PCB-mounted sample. Exclude CT series with thickness of less than 0.66mm.	No problem observed									
Bending Strength		Glass epoxy PCB: Fulcrum spacing: 90mm, duration time 10 seconds. Exclude CT series with thickness of less than 0.66mm.	No significant damage at 1mm bent									
Vibration Test	Appearance	Take the initial value after heat treatment. Vibration frequency: 10 to 55 (Hz) Amplitude: 1.5mm	No problem observed									
	ΔC	Sweeping condition: 10→55→10Hz/ 1 minute in X, Y and Z	Within tolerance									
	Tanδ (%)	Directions: 2 hours each, 6 hours total.	Within tolerance									
Soldering Heat Resistance	Appearance	Take the initial value after heat treatment.	No problem observed									
	ΔC	Soak the sample in 260°C±5°C solder for 10±0.5 seconds and place in room ambient, and measure after 24±2 hours.	Within ±20%									
	Tanδ (%)	(Pre-heating conditions)	Within tolerance									
	IR	<table border="1"> <thead> <tr> <th>Order</th> <th>Temperature</th> <th>Time</th> </tr> </thead> <tbody> <tr> <td>1</td> <td>80 to 100°C</td> <td>2 minutes</td> </tr> <tr> <td>2</td> <td>150 to 200°C</td> <td>2 minutes</td> </tr> </tbody> </table>	Order	Temperature	Time	1	80 to 100°C	2 minutes	2	150 to 200°C	2 minutes	Over 10000MΩ or 500MΩ • μF, whichever is less
	Order	Temperature	Time									
1	80 to 100°C	2 minutes										
2	150 to 200°C	2 minutes										
Withstanding Voltage	The charge and discharge current of the capacitor must not exceed 50mA for IR and withstanding voltage measurement.	Resist without problem										
Solderability		Soaking condition <table border="1"> <thead> <tr> <th>Solder</th> <th>Temperature</th> <th>Time</th> </tr> </thead> <tbody> <tr> <td>Sn63 Solder</td> <td>235±5°C</td> <td>2±0.5 sec.</td> </tr> <tr> <td>Sn-3Ag-0.5Cu</td> <td>245±5°C</td> <td>3±0.5 sec.</td> </tr> </tbody> </table>	Solder	Temperature	Time	Sn63 Solder	235±5°C	2±0.5 sec.	Sn-3Ag-0.5Cu	245±5°C	3±0.5 sec.	Solder coverage : 90% min.
Solder	Temperature	Time										
Sn63 Solder	235±5°C	2±0.5 sec.										
Sn-3Ag-0.5Cu	245±5°C	3±0.5 sec.										
Temperature Cycle	Appearance	Take the initial value after heat treatment. (Cycle)	No problem observed									
	ΔC	Room temperature (3min.)→	Within ±20%									
	Tanδ (%)	Lowest operation temperature (30min.)→ Room temperature (3min.)→	Within tolerance									
	IR	Highest operation temperature(30min.)	Over 10000MΩ or 500MΩ • μF, whichever is less									
	Withstanding Voltage	After 5 cycles, measure after 24±2 hours. The charge and discharge current of the capacitor must not exceed 50mA for IR and withstanding voltage measurement.	Resist without problem									
Load Humidity Test	Appearance	Take the initial value after voltage treatment.	No problem observed									
	ΔC	After applying rated voltage for 500+12/ -0 hours in pre-condition at 40°C±2°C, humidity 90 to 95%RH, allow parts to stabilize for 24±2 hours, at room temperature before measurement.	Within ±30%									
	Tanδ (%)	The charge and discharge current of the capacitor must not exceed 50mA for IR measurement.	150% max. of initial value									
	IR		Over 500MΩ or 25MΩ • μF, whichever is less									
High-Temperature with Loading	Appearance	Take the initial value after voltage treatment.	No problem observed									
	ΔC	After applying twice the rated voltage at the highest operation temperature for 1000+12/ -0 hours, measure the sample after 24±2 hours.	Within ±30%									
	Tanδ (%)	The charge and discharge current of the capacitor must not exceed 50mA for IR measurement.	150% max. of initial value									
	IR		Over 1000MΩ or 50MΩ • μF, whichever is less									
Pre-treatment	Heat	Keep specimen at 150+0/ -10°C for 1 hour, leave specimen at room ambient for 24±2 hours.										
	Voltage	Apply the same test condition for 1 hour, then leave the specimen at room ambient for 24±2 hours.										



**Test Conditions and Specifications for High Dielectric Type (X7R)  
CF Series**

Test Items		Test Conditions	Specifications										
Capacitance Value (C)		Measure after heat treatment	Within tolerance										
Tanδ (%)		<table border="1"> <thead> <tr> <th>Capacitance</th> <th>Frequency</th> <th>Volt</th> </tr> </thead> <tbody> <tr> <td>C≤10μF</td> <td>1kHz±10%</td> <td>1.0±0.2Vrms</td> </tr> </tbody> </table>	Capacitance	Frequency	Volt	C≤10μF	1kHz±10%	1.0±0.2Vrms	Within ±2.5%				
Capacitance	Frequency	Volt											
C≤10μF	1kHz±10%	1.0±0.2Vrms											
Insulation Resistance (IR)		<p>Measured after the rated voltage is applied for 1 minute at room ambient. Measured after the 500V is applied for 1 minute at room ambient for the rated voltage over 630V. The charge and discharge current of the capacitor must not exceed 50mA.</p>	Over 10000MΩ or 500MΩ • μF, whichever is less Over 100MΩ • μF for CF316X7R104/ 250V and CF43X7R474/ 250V CF55X7R105/ 250V and CF55X7R224/ 630V										
Dielectric Resistance		Apply 1.5 times when the rated voltage is 250V or over, apply 1.2 times when the rated voltage is 630V or over for 1 to 5 seconds. The charge and discharge current of the capacitor must not exceed 50mA.	No problem observed										
Appearance		Microscope (10× magnification)	No problem observed										
Termination Strength		Apply a sideward force of 500g (5N) to a PCB-mounted sample.	No problem observed										
Bending Strength		Glass epoxy PCB: Fulcrum spacing: 90mm, duration time 10 seconds.	No significant damage at 1mm bent										
Vibration Test	Appearance	Take the initial value after heat treatment. Vibration frequency: 10 to 55 (Hz) Amplitude: 1.5mm Sweeping condition: 10→55→10Hz/ 1 minute in X, Y and Z Directions: 2 hours each, 6 hours total.	No problem observed										
	ΔC		Within tolerance										
	Tanδ (%)		Within tolerance										
Soldering Heat Resistance	Appearance	Take the initial value after heat treatment. Soak the sample in 260°C±5°C solder for 10±0.5 seconds and place in room ambient, and measure after 24±2 hours. (Pre-heating conditions)	No problem observed										
	ΔC		Within ±7.5%										
	Tanδ (%)		Within tolerance										
	IR		<table border="1"> <thead> <tr> <th>Order</th> <th>Temperature</th> <th>Time</th> </tr> </thead> <tbody> <tr> <td>1</td> <td>80 to 100°C</td> <td>2 minutes</td> </tr> <tr> <td>2</td> <td>150 to 200°C</td> <td>2 minutes</td> </tr> </tbody> </table>	Order	Temperature	Time	1	80 to 100°C	2 minutes	2	150 to 200°C	2 minutes	Over 10000MΩ or 500MΩ • μF, whichever is less Over 100MΩ • μF for CF316X7R104/ 250V and CF43X7R474/ 250V CF55X7R105/ 250V and CF55X7R224/ 630V
	Order		Temperature	Time									
1	80 to 100°C	2 minutes											
2	150 to 200°C	2 minutes											
Withstanding Voltage	The charge and discharge current of the capacitor must not exceed 50mA for IR and withstanding voltage measurement.	Resist without problem											
Solderability		Soaking condition	Solder coverage : 90% min.										
		<table border="1"> <tbody> <tr> <td>Sn63 Solder</td> <td>235±5°C</td> <td>2±0.5 sec.</td> </tr> <tr> <td>Sn-3Ag-0.5Cu</td> <td>245±5°C</td> <td>3±0.5 sec.</td> </tr> </tbody> </table>	Sn63 Solder	235±5°C	2±0.5 sec.	Sn-3Ag-0.5Cu	245±5°C	3±0.5 sec.					
Sn63 Solder	235±5°C	2±0.5 sec.											
Sn-3Ag-0.5Cu	245±5°C	3±0.5 sec.											
Temperature Cycle	Appearance	Take the initial value after heat treatment. (Cycle) Room temperature (3min.)→ Lowest operation temperature (30min.)→ Room temperature (3min.)→ Highest operation temperature(30min.) After 5 cycles, measure after 24±2 hours. The charge and discharge current of the capacitor must not exceed 50mA for IR and withstanding voltage measurement.	No problem observed										
	ΔC		Within ±7.5%										
	Tanδ (%)		Within tolerance										
	IR		Over 10000MΩ or 500MΩ • μF, whichever is less Over 100MΩ • μF for CF316X7R104/ 250V and CF43X7R474/ 250V CF55X7R105/ 250V and CF55X7R224/ 630V										
	Withstanding Voltage		Resist without problem										
High-Temperature with Loading	Appearance	Take the initial value after voltage treatment. After applying specified voltage at the highest operation temperature for 1000+12/ -0 hours, then measure the sample after 24±2 hours. The applied voltage shall be; 1.5 times the rated voltage when the rated voltage is 250V or over. 1.2 times when the rated voltage is 630V or over. The charge and discharge current of the capacitor must not exceed 50mA for IR measurement.	No problem observed										
	ΔC		Within ±12.5%										
	Tanδ (%)		200% max. of initial value										
	IR		Over 1000MΩ or 50MΩ • μF, whichever is less										
Pre-treatment	Heat	Keep specimen at 150+0/ -10°C for 1 hour, leave specimen at room ambient for 24±2 hours.											
	Voltage	Apply the same test condition for 1 hour, then leave the specimen at room ambient for 24±2 hours.											



## Substrate for Electrical Tests

(Unit: mm)

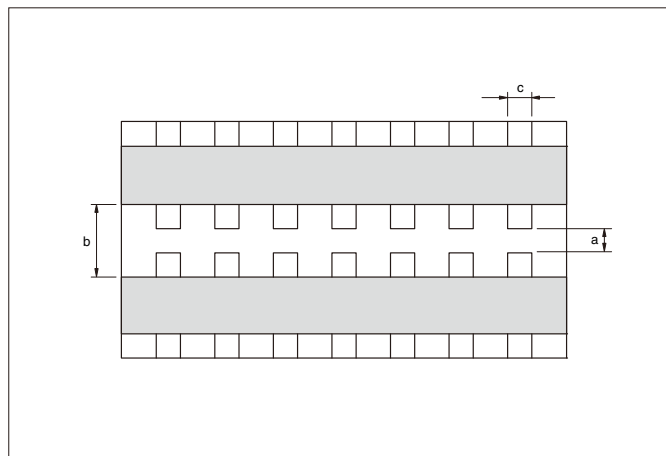

Size (EIA Code)	a	b	c
02 (01005)	0.15	0.50	0.20
03 (0201)	0.26	0.92	0.32
05 (0402)	0.4	1.4	0.5
105 (0603)	1.0	3.0	1.2
21 (0805)	1.2	4.0	1.65
316 (1206)	2.2	5.0	2.0
32 (1210)	2.2	5.0	2.9
42 (1808)	3.5	7.0	3.7
43 (1812)	3.5	7.0	3.7
52 (2208)	4.5	8.0	5.6
55 (2220)	4.5	8.0	5.6

## Substrate for Bending Test

(Unit: mm)

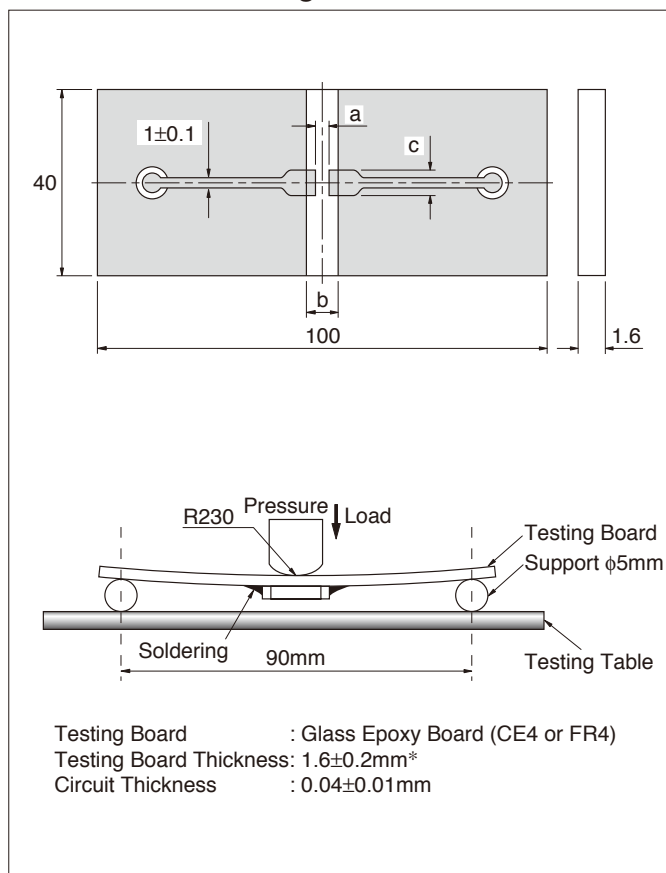

\* 02, 03, 05 and array:  $0.8 \pm 0.1\text{mm}$

## Substrate for Adhesion Strength Test

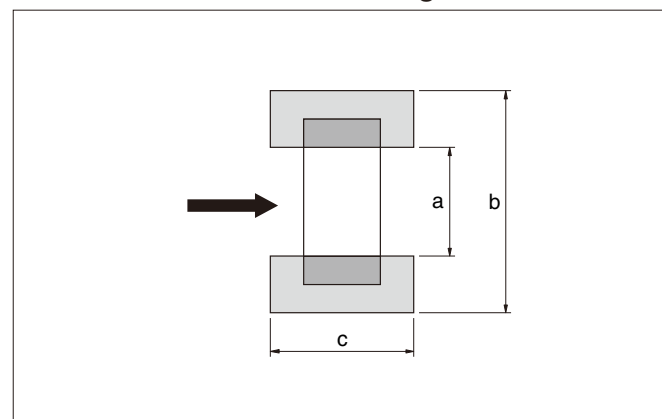



## Tape and Reel

- Reel

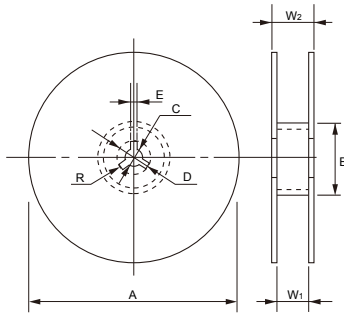

## Reel

(Unit: mm)

Code Reel	A	B	C	D
7-inch Reel (CODE: T, H, Q, P)	180 <sup>+0</sup> <sub>-2.0</sub>	φ60 min.	13±0.5	21±0.8
13-inch Reel (CODE: L, N)	330±2.0	φ100±1.0		
Code Reel	E	W <sub>1</sub>	W <sub>2</sub>	R
7-inch Reel (CODE: T, H, Q)	2.0±0.5	10.0±1.5	16.5 max.	1.0
13-inch Reel (CODE: L, N)		9.5±1.0		

\* Carrier tape width 8mm.

For size 42 (1808) or over, Tape width 12mm and W<sub>1</sub>: 14±1.5, W<sub>2</sub>: 18.4mm max.

### F=1mm (02 Type)

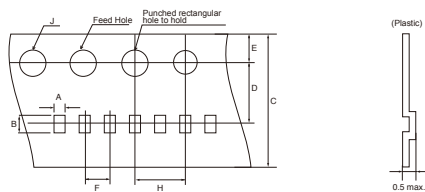

### F=1mm (02, 03, 05 Type)

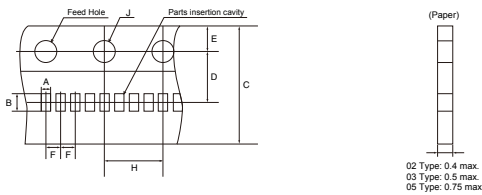

### F=2mm (03, 05, 105 Type)

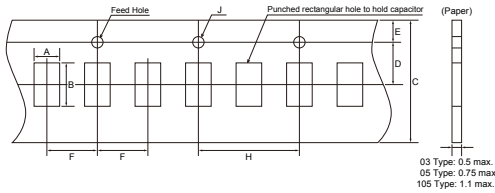

### F=4mm (105, D11, F12, 21, 316, 32, 42, 52 Type)

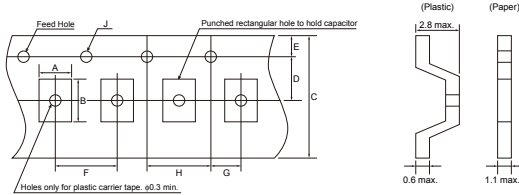

### F=8mm (43, 55 Type)

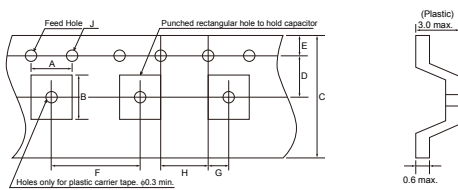

## Carrier Tape

(Unit: mm)

Size (EIA Code)	A	B	F
02 (01005)	0.23±0.02	0.43±0.02	1.0±0.02
	0.25±0.03	0.45±0.03	2.0±0.05
03 (0201)*	0.37±0.03	0.67±0.03	1.0±0.05
			2.0±0.05
05 (0402)	0.65±0.1	1.15±0.1	1.0±0.05
105 (0603)	1.0±0.2	1.8±0.2	2.0±0.05
21 (0805)	1.5±0.2	2.3±0.2	4.0±0.1
316 (1206)	2.0±0.2	3.6±0.2	4.0±0.1
32 (1210)	2.9±0.2	3.6±0.2	4.0±0.1
42 (1808)	2.4±0.2	4.9±0.2	4.0±0.1
43 (1812)	2.4±0.2	4.9±0.2	4.0±0.1
52 (2208)	2.4±0.2	4.9±0.2	8.0±0.1
55 (2220)	2.4±0.2	6.0±0.2	4.0±0.1
D11 (0405)	5.3±0.2	6.0±0.2	8.0±0.1
D11 (0405)	1.15±0.2	1.55±0.2	4.0±0.1
F12 (0508)	1.5±0.2	2.3±0.2	4.0±0.1

\* Option : A : 0.39±0.03, B : 0.69±0.03

(Unit: mm)

F	Carrier Tape	C	D	E	G	H	J
1.0 ±0.02	4mm Plastic	4.0 +0.05	1.8 ±0.02	0.9 ±0.05	-	2.0 ±0.04	0.8 ±0.02
1.0 ±0.05	1mm Paper	8.0 +0.3/-0.1	3.5 ±0.05	1.75 ±0.1	2.0 ±0.05	4.0 ±0.05	1.5 +0.1/-0
2.0 ±0.05	8mm Paper	8.0 ±0.3				4.0 ±0.1	
4.0 ±0.1	8mm Plastic	12.0 ±0.3				5.5 ±0.05	
8.0 ±0.1	12mm Plastic	12.0 ±0.3	5.5 ±0.05				



## Detail of leader and trailer

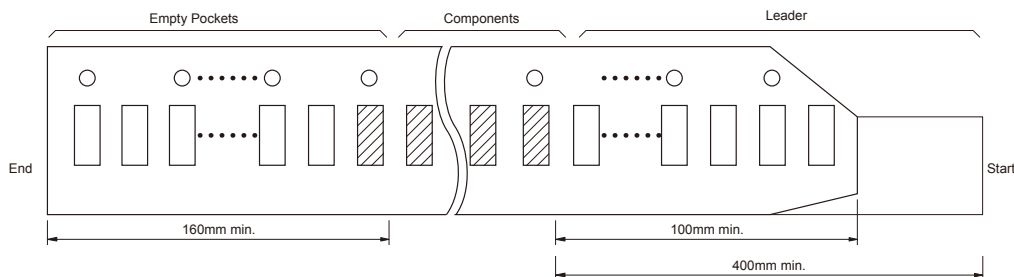

## Adhesive tape

- 1) The exfoliative strength when peeling off the top tape from the carrier tape by the method of the following figure shall be  $\approx 0.1$  to  $0.7N$ . \*02 Size:  $0.1$  to  $0.5N$
- 2) When the top tape is peeled off, the adhesive stays on the top tape.
- 3) Chip capacitors will be in a state free without being stuck on the thermal adhesive tape.

Exfoliating angle:  $165$  to  $180$  degrees to the carrier tape.  
Exfoliating speed:  $300$  mm/min.

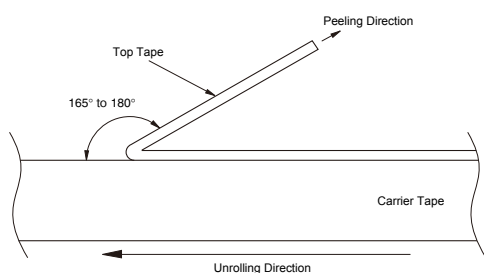

## Bulk Case

(Unit: mm)

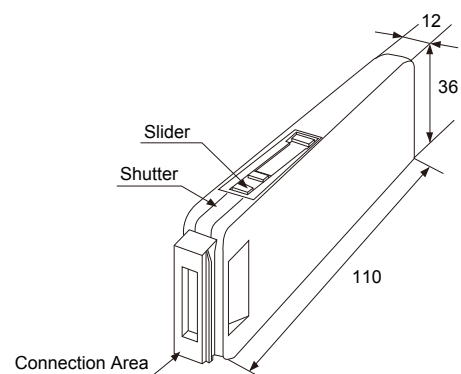

• Please contact Kyocera for details.





## Dimensions for recommended typical land

Since the amount of solder (size of fillet) to be used has direct influence on the capacitor after mounting, the sufficient consideration is necessary.

When the amounts of solder is too much, the stress that a capacitor receives becomes larger. It may become the cause of a crack in the capacitor. When the land design of printed wiring board is considered, it is necessary to set up the form and size of land pattern so that the amount of solder is suitable.

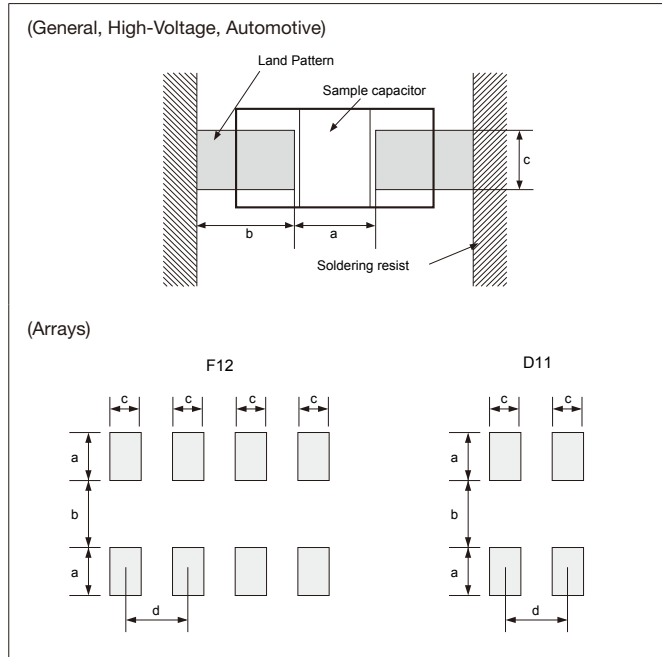

## General, High-Voltage

(Unit: mm)

Size (EIA Code)	L×W	a	b	c
02 (01005)	0.4×0.2	0.13 to 0.20	0.12 to 0.18	0.20 to 0.23
03 (0201)	0.6×0.3	0.20 to 0.30	0.25 to 0.35	0.30 to 0.40
05 (0402)	1.0×0.5	0.30 to 0.50	0.35 to 0.45	0.40 to 0.60
105 (0603)	1.6×0.8	0.70 to 1.00	0.80 to 1.00	0.60 to 0.80
21 (0805)	2.0×1.25	1.00 to 1.30	1.00 to 1.20	0.80 to 1.10
316 (1206)	3.2×1.6	2.10 to 2.50	1.10 to 1.30	1.00 to 1.30
32 (1210)	3.2×2.5	2.10 to 2.50	1.10 to 1.30	1.90 to 2.30
42 (1808)	4.5×2.0	2.50 to 3.20	1.80 to 2.30	1.50 to 1.80
43 (1812)	4.5×3.2	2.50 to 3.20	1.80 to 2.30	2.60 to 3.00
52 (2208)	5.7×2.0	4.20 to 4.70	2.00 to 2.50	1.50 to 1.80
55 (2220)	5.7×5.0	4.20 to 4.70	2.00 to 2.50	4.20 to 4.70

## Automotive

(Unit: mm)

Size (EIA Code)	L×W	a	b	c
105 (0603)	1.6×0.8	0.60 to 0.90	0.80 to 1.00	0.70 to 1.00
21 (0805)	2.0×1.25	0.90 to 1.20	0.80 to 1.20	0.90 to 1.40
316 (1206)	3.2×1.6	1.40 to 1.90	1.00 to 1.30	1.30 to 1.80

## Arrays

(Unit: mm)

	a	b	c	d
F12 (0508)	0.5	0.5	0.3	0.5
D11 (0405)	0.69	0.28	0.3	0.64

## Ideal Solder Height

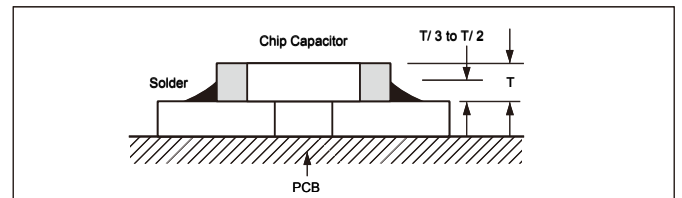

## Design of printed circuit and Soldering

The recommended fillet height shall be 1/2 to 1/3 of the thickness of capacitors. When mounting two or more capacitors in the common land, it is necessary to separate the land with the solder resist strike so that it may become the exclusive land of each capacitor.

Item	Not recommended example	Recommended example/ Separated by solder
Multiple parts mount		
Mount with leaded parts		
Wire soldering after mounting		
Overview		



## Mounting Design

The chip could crack if the PCB warps during processing after the chip has been soldered.

### Recommended chip position on PCB to minimize stress from PCB warpage



## Actual Mounting

- 1) If the position of the vacuum nozzle is too low, a large force may be applied to the chip capacitor during mounting, resulting in cracking.
- 2) During mounting, set the nozzle pressure to a static load of 100 to 300 gf.
- 3) To minimize the shock of the vacuum nozzle, provide a support pin on the back of the PCB to minimize PCB flexure.

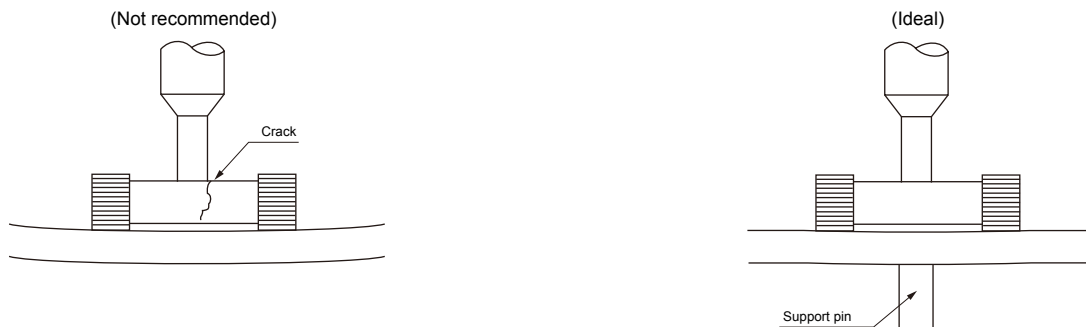

- 4) Bottom position of pick up nozzle should be adjusted to the top surface of a substrate which camber is corrected.
- 5) To reduce the possibility of chipping and cracks, minimize vibration to chips stored in a bulk case.
- 6) The discharge pressure must be adjusted to the part size. Verify the pressure during setup to avoid fracturing or cracking the chips capacitors.

## Resin Mold

- 1) If a large amount of resin is used for molding the chip, cracks may occur due to contraction stress during curing. To avoid such cracks, use a low shrinkage resin.
- 2) The insulation resistance of the chip will degrade due to moisture absorption. Use a low moisture absorption resin.
- 3) Check carefully that the resin does not generate a decomposition gas or reaction gas during the curing process or during normal storage. Such gases may crack the chip capacitor or damage the device itself.



## Soldering Method

- 1) Ceramic is easily damaged by rapid heating or cooling. If some heat shock is unavoidable, preheat enough to limit the temperature difference (Delta T) to within 130 degree Celsius.
- 2) The product size 1.6x0.8mm to 3.2x1.6mm can be used in reflow and wave soldering, and the product size of bigger than 3.2x1.6mm, or smaller than 1.6x0.8mm, and capacitor arrays can be used in reflow.  
Circuit shortage and smoking can be created by using capacitors which are used neglecting the above caution.
- 3) Please see our recommended soldering conditions.
- 4) In case of using Sn-Zn Solder, please contact us in advance.
- 5) The following condition is recommended for spot heater application.

### • Recommended spot heater condition

Item	Condition
Distance	5mm min.
Angle	45°
Projection Temp.	400°C max.
Flow rate	Set at the minimum
Nozzle diameter	2φ to 4φ (Single hole type)
Application time	10 sec. max. (1206 and smaller) 30 sec. max. (1210 and larger)

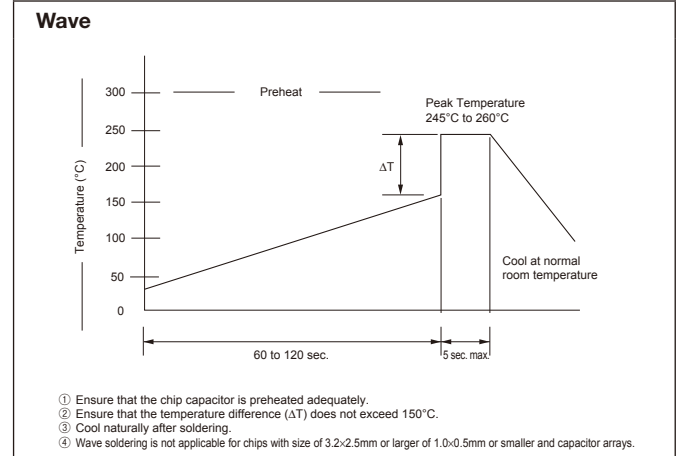
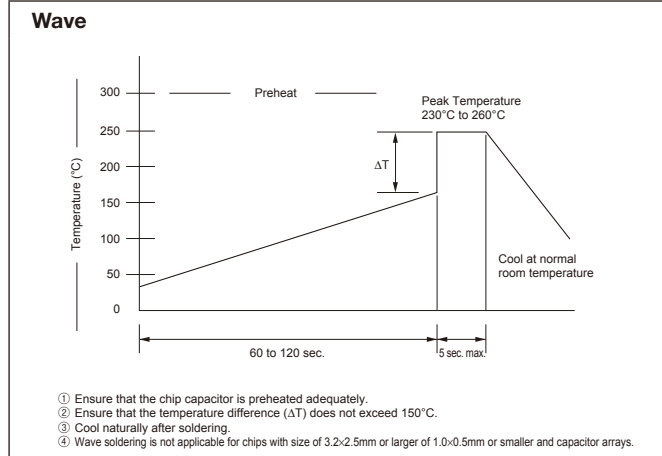
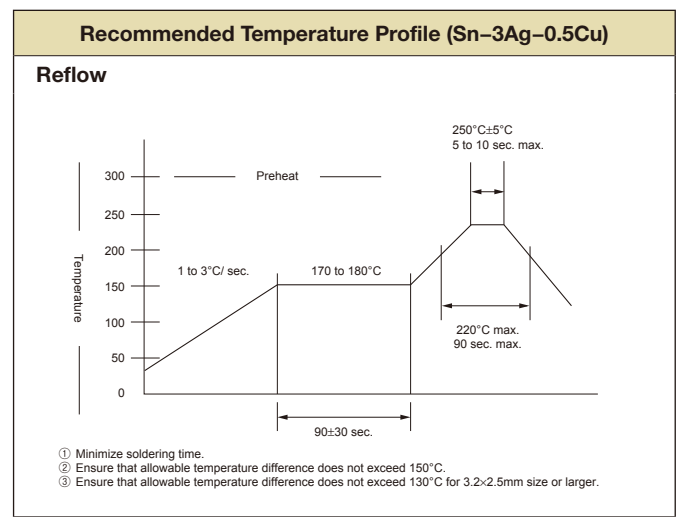
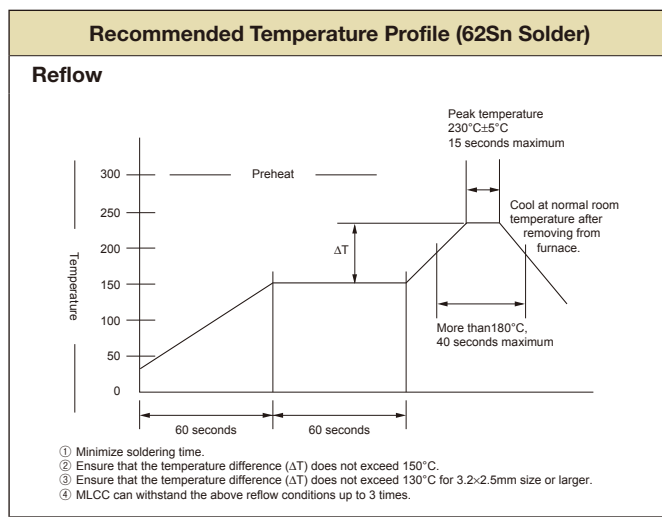
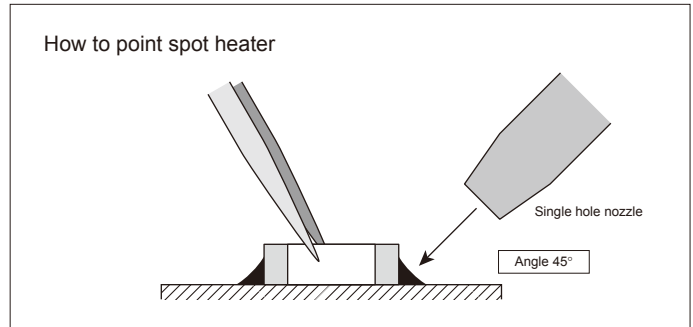

## Soldering iron

- |                                |                             |   |
|--------------------------------|-----------------------------|---|
| 1) Temperature of iron chip    | 1206 and smaller 350°C max. | 5) Cautions   |
|                                | 1210 and larger 280°C max.  | a) Pre-heating is necessary rapid heating must be avoided.<br>Delta T ≤ 150°C                 |
| 2) Wattage                     | 80W max.                    | b) Avoid direct touching to capacitors.   |
| 3) Tip shape of soldering iron | φ3.0mm max.                 | c) Avoid rapid cooling after soldering. Natural cooling is recommended.                       |
| 4) Soldering Time              | 3 sec. max.                 | *Consult as if it is difficult to keep the temperature 280°C max. for 1210 and larger MLCC'S. |



## Circuit Design

1. Once application and assembly environments have been checked, the capacitor may be used in conformance with the rating and performance which are provided in both the catalog and the specifications. Use exceeding that which is specified may result in inferior performance or cause a short, open, smoking, or flaming to occur, etc.
2. Please consult the manufacturer in advance when the capacitor is used in devices such as: devices which deal with human life, i.e. medical devices; devices which are highly public orientated; and devices which demand a high standard of liability.  
Accident or malfunction of devices such as medical devices, space equipment and devices having to do with atomic power could generate grave consequence with respect to human lives or, possibly, a portion of the public. Capacitors used in these devices may require high reliability design different from that of general purpose capacitors.
3. Please use the capacitors in conformance with the operating temperature provided in both the catalog and the specifications.  
Be especially cautious not to exceed the maximum temperature. In the situation the maximum temperature set forth in both the catalog and specifications is exceeded, the capacitor's insulation resistance may deteriorate, power may suddenly surge and short-circuit may occur. The capacitor has a loss, and may self-heat due to equivalent series resistance when alternating electric current is passed therethrough. As this effect becomes especially pronounced in high frequency circuits, please exercise caution.  
When using the capacitor in a (self-heating) circuit, please make sure the surface of the capacitor remains under the maximum temperature for usage. Also, please make certain temperature rises remain below 20°C.
4. Please keep voltage under the rated voltage which is applied to the capacitor. Also, please make certain the peak voltage remains below the rated voltage when AC voltage is super-imposed to the DC voltage.  
In the situation where AC or pulse voltage is employed, ensure average peak voltage does not exceed the rated voltage.  
Exceeding the rated voltage provided in both catalog and specifications may lead to defective withstanding voltage or, in worst case situations, may cause the capacitor to smoke or flame.
5. When the capacitor is to be employed in a circuit in which there is continuous application of a high frequency voltage or a steep pulse voltage, even though it is within the rated voltage, please inquire to the manufacturer.  
In the situation the capacitor is to be employed using a high frequency AC voltage or a extremely fast rising pulse voltage, even though it is within the rated voltage, it is possible capacitor reliability will deteriorate.
6. It is a common phenomenon of high-dielectric products to have a deteriorated amount of static electricity due to the application of DC voltage.  
Due caution is necessary as the degree of deterioration varies depending on the quality of capacitor materials, capacity, as well as the load voltage at the time of operation.
7. Do not use the capacitor in an environment where it might easily exceed the respective provisions concerning shock and vibration specified in the catalog and specifications.  
In addition, it is a common piezo phenomenon of high dielectric products to have some voltage due to vibration or to have noise due to voltage change. Please contact sales in such case.
8. If the electrostatic capacity value of the delivered capacitor is within the specified tolerance, please consider this when designing the respective product in order that the assembled product function appropriately.
9. Please contact us upon using conductive adhesives.

## Storage

1. If the component is stored in minimal packaging (a heat-sealed or chuck-type plastic bag), the bag should be kept closed. Once the bag has been opened, reseal it or store it in a desiccator.
2. Keep storage place temperature +5 to +40 degree C, humidity 20 to 70% RH.
3. The storage atmosphere must be free of gas containing sulfur and chlorine. Also, avoid exposing the product to saline moisture. If the product is exposed to such atmospheres, the terminals will oxidize and solderability will be effected.
4. Precautions 1) to 3) apply to chip capacitors packaged in carrier tapes and bulk cases.
5. The solderability is assured for 12 months from our shipping date (six months for silver palladium) if the above storage precautions are followed.
6. Chip capacitors may crack if exposed to hydrogen (H<sub>2</sub>) gas while sealed or if coated with silicon, which generates hydrogen gas.

Safety application guideline and detailed information of electrical properties are also provided in Kyocera home page;  
URL: <http://www.kyocera.co.jp/electronic/>