



FEATURES

- Patents protected
- Lower profile
- UL60950 recognised
- ANSI/AAMI ES60601-1 recognised
- 3kVDC isolation "Hi Pot Test"
- Substrate embedded transformer
- Automated manufacture
- Industry standard footprint
- Short circuit protection³
- Halogen free

PRODUCT OVERVIEW

The NXE2 series is a new range of low cost, lower profile, fully automated manufacture surface mount DC-DC converters. The NXE2 series automated manufacturing process with substrate embedded transformer, offers increased product reliability and repeatability of performance in a halogen free, iLGA inspectable package. The NXE2 series, industry standard footprint is compatible with existing designs.

The NXE2 series has a MSL rating 2, and is compatible with a peak reflow solder temperature of 260°C as per J-STD-020.

SELECTION GUIDE

| Order Code ¹ | Nominal Input Voltage | Output Voltage | Input Current | Output Current | Load Regulation (Typ) | Load Regulation (Max) | Output Ripple & Noise (Typ) | Output Ripple & Noise (Max) | Efficiency (Min) | Efficiency (Typ) | Isolation Capacitance | MTTF ² | |
|-------------------------|-----------------------|----------------|---------------|----------------|-----------------------|-----------------------|-----------------------------|-----------------------------|------------------|------------------|-----------------------|-------------------|-------|
| | V | V | mA | mA | % | % | mVp-p | mVp-p | % | % | | MIL | Tel. |
| | | | | | | | | | | | | pF | kHrs |
| NXE2S0505MC | 5 | 5 | 542 | 400 | 9 | 12 | 55 | 85 | 68.5 | 72 | 2.1 | 1853 | 18868 |
| NXE2S1205MC | 12 | 5 | 220 | 400 | 11 | 12 | 50 | 85 | 74.5 | 77 | 2.1 | 1800 | 46838 |
| NXE2S1212MC | 12 | 12 | 210 | 167 | 7 | 8.5 | 25 | 55 | 74.5 | 76.5 | 2.1 | 1848 | 22472 |
| NXE2S1215MC | 12 | 15 | 205 | 133 | 8.5 | 11 | 30 | 60 | 76 | 79 | 2.1 | 1631 | 58568 |

INPUT CHARACTERISTICS

| Parameter | Conditions | Min. | Typ. | Max. | Units |
|--------------------------------|---------------------------------------|------|------|------|--------|
| Voltage range | Continuous operation, 5V input types | 4.5 | 5 | 5.5 | V |
| | Continuous operation, 12V input types | 10.8 | 12 | 13.2 | |
| Input reflected ripple current | NXE2S0505MC | | 4 | | mA p-p |
| | NXE2S1205MC | | 2.5 | | |
| | NXE2S1212MC | | 3.3 | | |
| | NXE2S1215MC | | 2.8 | | |

OUTPUT CHARACTERISTICS

| Parameter | Conditions | Min. | Typ. | Max. | Units |
|------------------------------|--|------|------|------|-------|
| Rated power | T _A =-40°C to 85°C | | | 2.0 | W |
| Voltage set point accuracy | See tolerance envelopes | | | | |
| Line regulation ⁴ | High V _{IN} to low V _{IN} , All other variants | | 1.15 | 1.2 | %/% |
| | High V _{IN} to low V _{IN} , 1205 variant | | 1.15 | 1.26 | |

ISOLATION CHARACTERISTICS

| Parameter | Conditions | Min. | Typ. | Max. | Units |
|-------------------|-----------------------------------|------|------|------|-------|
| Isolation voltage | Production tested for 1 second | 3000 | | | VDC |
| | Qualification tested for 1 minute | 3000 | | | |
| Resistance | Viso= 1000VDC | 10 | | | GΩ |

GENERAL CHARACTERISTICS

| Parameter | Conditions | Min. | Typ. | Max. | Units |
|---------------------|-------------|------|------|------|-------|
| Switching frequency | NXE2S0505MC | | 130 | | kHz |
| | NXE2S1205MC | | 100 | | |
| | NXE2S1212MC | | 115 | | |
| | NXE2S1215MC | | 100 | | |

TEMPERATURE CHARACTERISTICS

| Parameter | Conditions | Min. | Typ. | Max. | Units |
|-------------------------------------|---------------------|------|------|------|-------|
| Specification | See derating graphs | -40 | | 85 | °C |
| Storage | | -50 | | 125 | |
| Case temperature rise above ambient | NXE2S0505MC | | 36 | | |
| | NXE2S1205MC | | 32 | | |
| | NXE2S1212MC | | 28 | | |
| | NXE2S1215MC | | 27 | | |
| Cooling | Free air convection | | | | |

ABSOLUTE MAXIMUM RATINGS

| | |
|---|-----|
| Input voltage V _{IN} , NXE2S05 types | 7V |
| Input voltage V _{IN} , NXE2S12 types | 15V |

- Components are supplied in tape and reel packaging, please refer to package specification section. Orderable part numbers are NXE2SXXXXMC-R7 (180 pieces per reel), or NXE2SXXXXMC-R13 (800 pieces per reel).
 - Calculated using MIL-HDBK-217 FN2 and Telcordia SR-332 calculation model with nominal input voltage at full load.
 - Please refer to short circuit application notes.
 - NXE2S1205MC line regulation may increase to 2.15 %/ at the operating temperature limits.
- All specifications typical at T_A=25°C, nominal input voltage and rated output current unless otherwise specified.



For full details go to
www.murata-ps.com/rohs



TECHNICAL NOTES

ISOLATION VOLTAGE

'Hi Pot Test', 'Flash Tested', 'Withstand Voltage', 'Proof Voltage', 'Dielectric Withstand Voltage' & 'Isolation Test Voltage' are all terms that relate to the same thing, a test voltage, applied for a specified time, across a component designed to provide electrical isolation, to verify the integrity of that isolation.

Murata Power Solutions NXE2 series of DC-DC converters are all 100% production tested at 3kVDC for 1 second and have been qualification tested at 3kVDC for 1 minute.

A question commonly asked is, "What is the continuous voltage that can be applied across the part in normal operation?"

When the insulation in the NXE2 series is not used as a safety barrier, i.e. provides functional isolation only, continuous or switched voltages across the barrier up to 3kV are sustainable. Long term reliability testing at these voltages continues. Peak Inception voltages measured were in excess of 3.5kV when testing for partial discharge in accordance with IEC 60270. Please contact Murata for further information.

The NXE2 series has been recognised by Underwriters Laboratory to 125Vrms Reinforced Insulation and 250Vrms Basic insulation, please see safety approval section below.

REPEATED HIGH-VOLTAGE ISOLATION TESTING

It is well known that repeated high-voltage isolation testing of a barrier component can actually degrade isolation capability, to a lesser or greater degree depending on materials, construction and environment. The NXE2 series has a PCB embedded isolated transformer, using FR4 as an insulation barrier between primary and secondary windings. While parts can be expected to withstand several times the stated test voltage, the isolation capability does depend on the FR4 insulation properties. Any material, including FR4 is susceptible to eventual chemical degradation when subject to very high applied voltages thus implying that the number of tests should be strictly limited. We therefore strongly advise against repeated high voltage isolation testing, but if it is absolutely required, that the voltage should be reduced by 20% from specified test voltage.

This consideration equally applies to agency recognised parts rated for better than functional isolation where the insulation is always supplemented by a further insulation system of physical spacing or barriers.

SAFETY APPROVAL

ANSI/AAMI ES60601-1

The NXE2 series is recognised by Underwriters Laboratory (UL) to ANSI/AAMI ES60601-1 and provides 1 MOOP (Means Of Operator Protection) based upon a working voltage of 250 Vrms max, between Primary and Secondary.

UL 60950

The NXE2 series has been recognised by Underwriters Laboratory (UL) to UL 60950 for reinforced insulation to a working voltage of 125Vrms and for basic insulation to a working voltage of 250Vrms.

Creepage is 2.5mm and clearance is 2mm

FUSING

The NXE2 Series of converters are not internally fused so to meet the requirements of UL an anti-surge input line fuse should always be used with ratings as defined below.

Input Voltage, 5V 1A

Input Voltage, 12V 400mA

All fuses should be UL recognised, V rated.

RoHS COMPLIANCE, MSL, PSL AND REFLOW SOLDERING INFORMATION



This series is compatible with Pb-Free soldering systems and is also backward compatible with Sn/Pb soldering systems. Please refer to [application notes](#) for further information. The NXE2 series can be soldered in accordance with J-STD-020 and have a classification temperature of 260°C and moisture sensitivity level 2. The termination finish on this product is Gold with plating thickness 0.12 microns.

PART NUMBER STRUCTURE

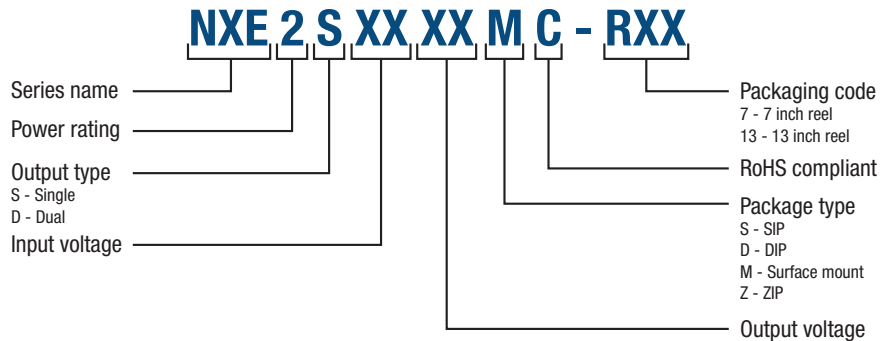

CHARACTERISATION TEST METHODS

Ripple & Noise Characterisation Method

Ripple and noise measurements are performed with the following test configuration.

| | |
|-------|--|
| C1 | 1µF X7R multilayer ceramic capacitor, voltage rating to be a minimum of 3 times the output voltage of the DC-DC converter |
| C2 | 10µF tantalum capacitor, voltage rating to be a minimum of 1.5 times the output voltage of the DC-DC converter with an ESR of less than 100mΩ at 100 kHz |
| C3 | 100nF multilayer ceramic capacitor, general purpose |
| R1 | 450Ω resistor, carbon film, ±1% tolerance |
| R2 | 50Ω BNC termination |
| T1 | 3T of the coax cable through a ferrite toroid |
| RLOAD | Resistive load to the maximum power rating of the DC-DC converter. Connections should be made via twisted wires |

Measured values are multiplied by 10 to obtain the specified values.

Differential Mode Noise Test Schematic

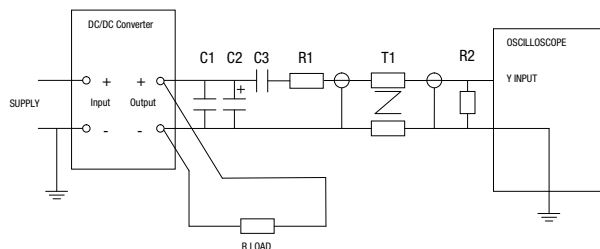

APPLICATION NOTES

Short Circuit Performance

The NXE2S0505MC offers short circuit protection at low ambient temperatures from -40°C to the temperatures shown in the below graph. The NXE2S12XXMC variants offer only momentary short circuit protection.

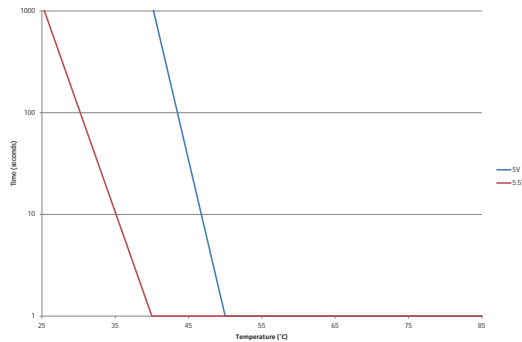

Advisory Notes

The NXE2 series is not hermetically sealed, customers should ensure that parts are fully dried before input power application.

Minimum Load

The minimum load to meet datasheet specification is 10% of the full rated load across the specified input voltage range. Lower than 10% minimum loading will result in an increase in output voltage, which may rise to typically double the specified output voltage if the output load falls to less than 5%.

Capacitive Loading & Start Up

Typical start up times for this series, with a typical input voltage rise time of 2.2µs and output capacitance of 10µF, are shown in the table below. The product series will start into a capacitance of 47µF with an increased start time, however, the maximum recommended output capacitance is 10µF.

| | Start-up time µS |
|-------------|---------------------|
| NXE2S0505MC | 260 |
| NXE2S1205MC | 160 |
| NXE2S1212MC | 550 |
| NXE2S1215MC | 870 |

Typical Start-Up Wave Form

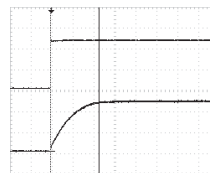

Output Ripple Reduction

By using the values of inductance and capacitance stated, the output ripple at the rated load is lowered to 5mV p-p max.

Component selection

Capacitor: It is required that the ESR (Equivalent Series Resistance) should be as low as possible, ceramic types are recommended. The voltage rating should be at least twice (except for 15V output), the rated output voltage of the DC-DC converter.

Inductor: The rated current of the inductor should not be less than that of the output of the DC-DC converter. At the rated current, the DC resistance of the inductor should be such that the voltage drop across the inductor is <2% of the rated voltage of the DC-DC converter. The SRF (Self Resonant Frequency) should be >20MHz.

| | L, µH | Inductor | | Capacitor C, µF |
|-------------|-------|----------|--------------|--------------------|
| | | SMD | Through Hole | |
| NXE2S0505MC | 22 | 84223C | 15223C | 10 |
| NXE2S1205MC | 22 | 84223C | 15223C | 10 |
| NXE2S1212MC | 22 | 82223C | 15223C | 10 |
| NXE2S1215MC | 22 | 82223C | 15223C | 47 |

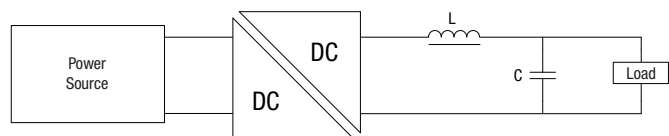

TOLERANCE ENVELOPES

The voltage tolerance envelopes show typical load regulation characteristics for this product series. The tolerance envelope is the maximum output voltage variation due to changes in output loading and set point accuracy. NXE2S1205MC & NXE2S1212MC output voltage will be outside the tolerance envelope at operating temperature limits.

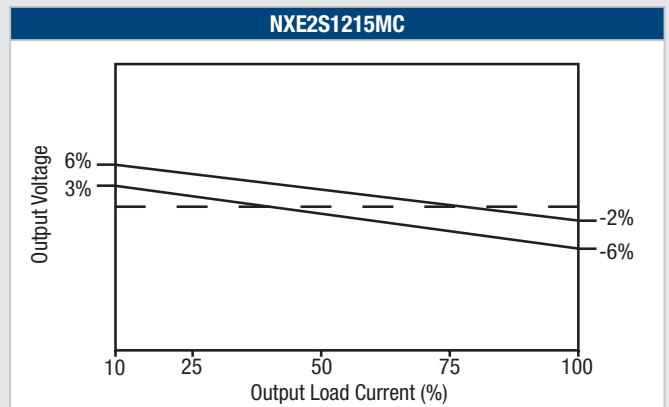
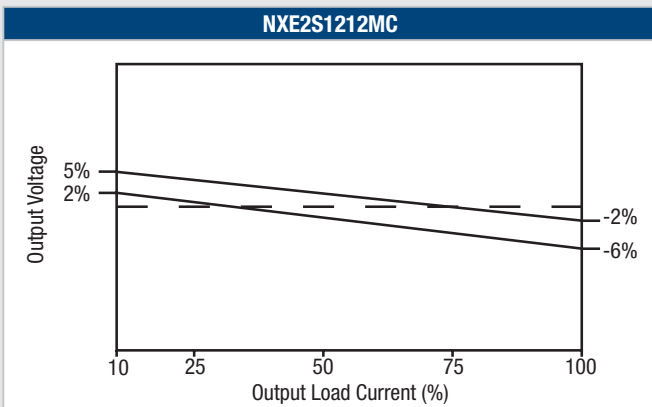
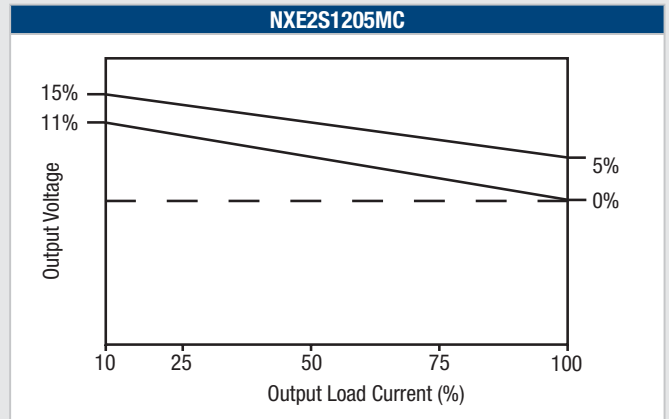
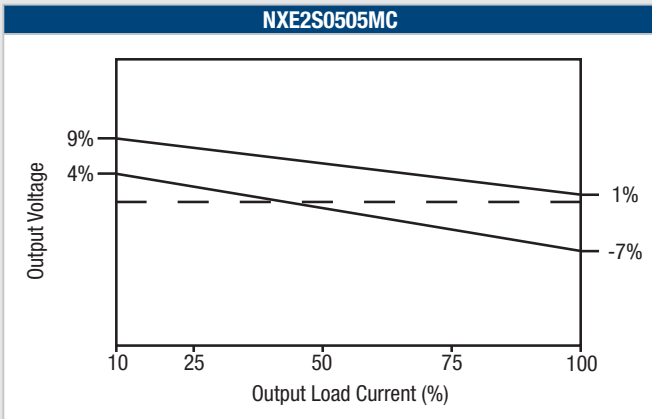

EFFICIENCY VS LOAD

NXE2S0505MC

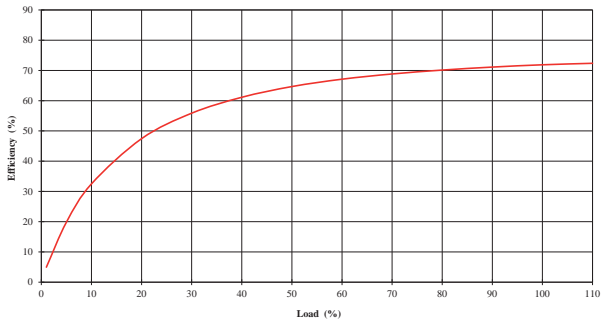

NXE2S1205MC

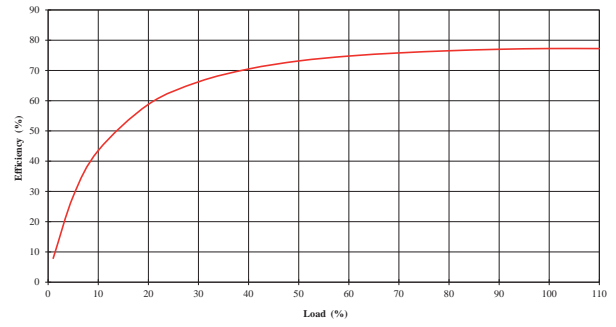

NXE2S1212MC

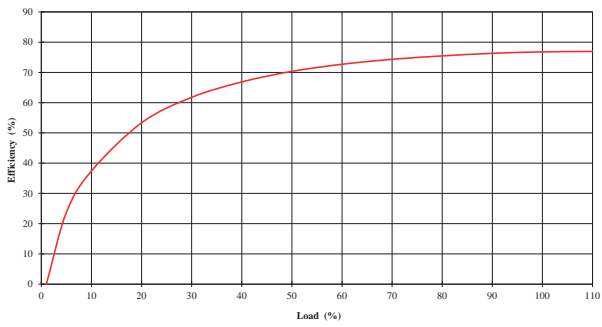

NXE2S1215MC

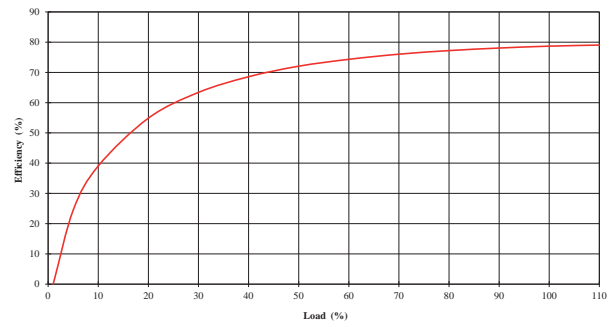

DERATING GRAPHS

NXE2S0505MC

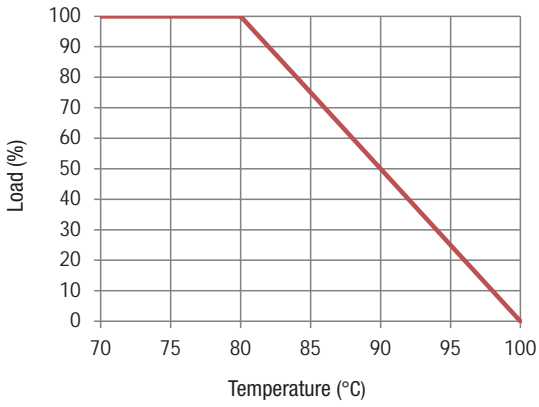

NXE2S1205MC

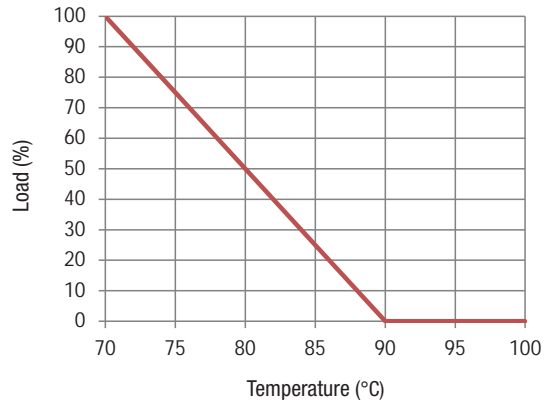

NXE2S1212MC

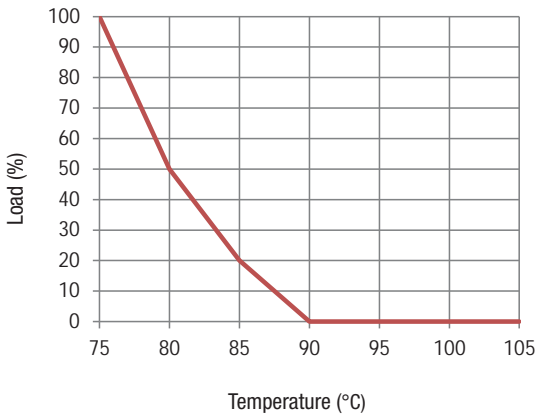

NXE2S1215MC

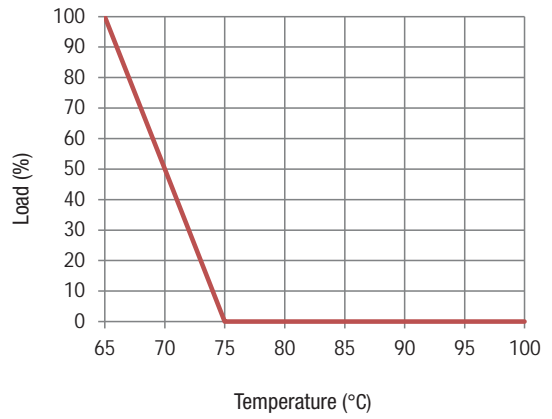

EMC FILTERING AND SPECTRA

FILTERING

The following table shows the additional input capacitor and input inductor typically required to meet EN 55022 Curve B Quasi-Peak EMC limit, as shown in the following plots.

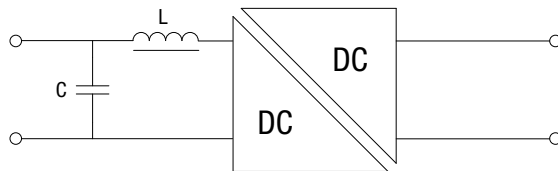

| Part Number | Capacitor | Inductor |
|--------------------|-------------|------------|
| NXE2S0505MC | 4.7 μ F | 15 μ H |
| NXE2S1205MC | 4.7 μ F | 15 μ H |
| NXE2S1212MC | 3.3 μ F | 10 μ H |
| NXE2S1215MC | 3.3 μ F | 22 μ H |

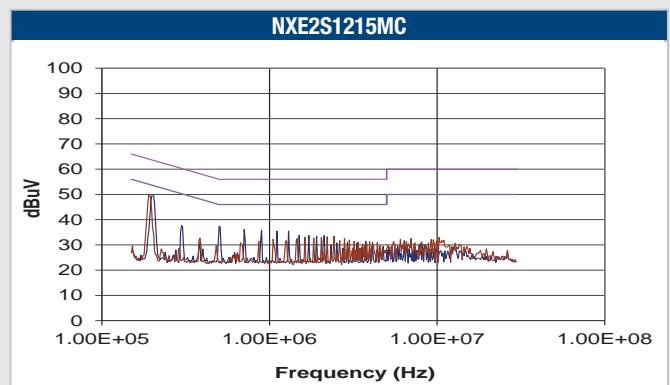
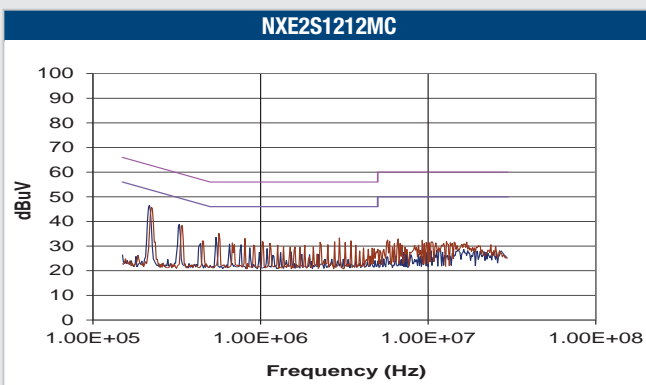
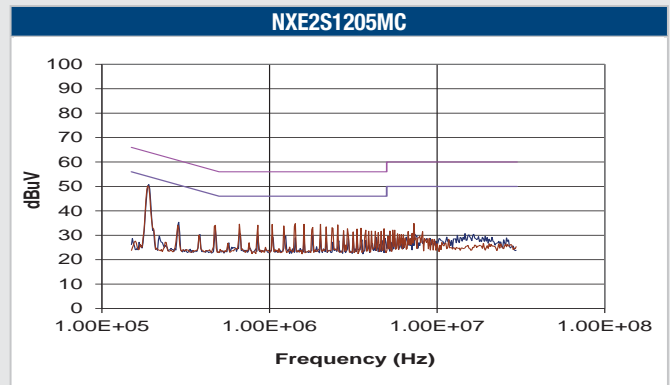
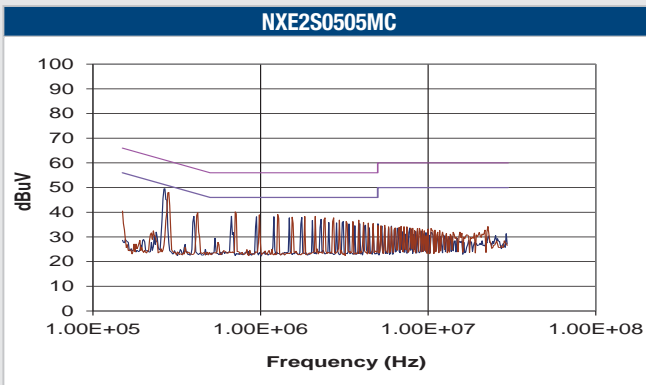

PACKAGE SPECIFICATIONS

Mechanical Dimensions

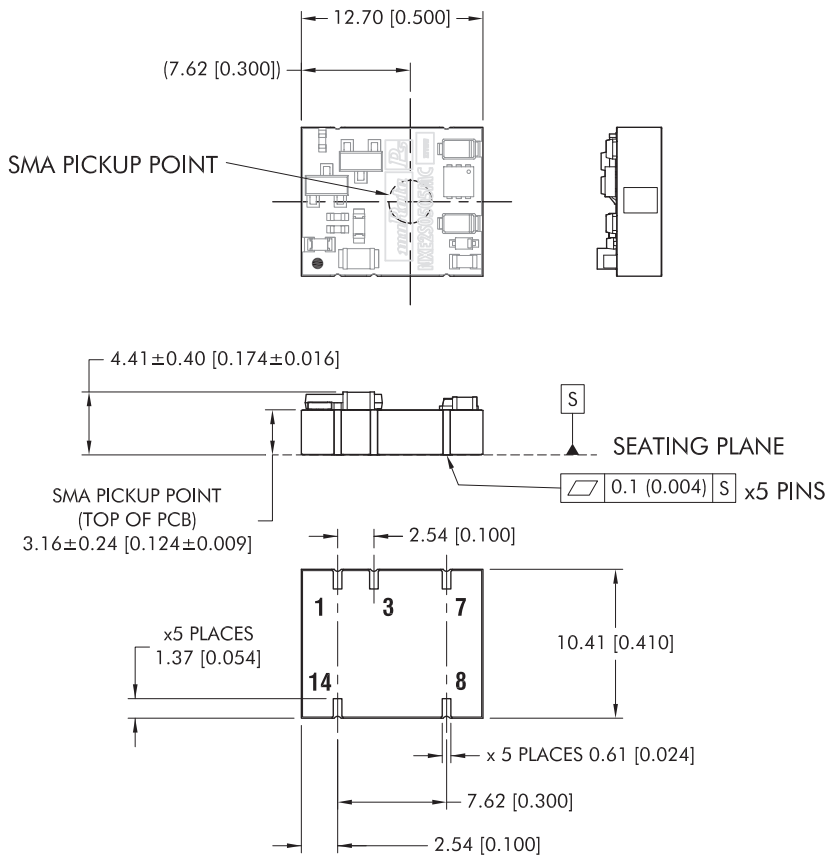

All dimensions in mm (inches), Controlling dimension is mm.
 Tolerances (unless otherwise stated) ±0.2 (0.008).
 Components shown for reference only

Weight: 1.1g

Pin Connections

| Pin | Function |
|-----|----------|
| 1 | -Vin |
| 3 | +Vin |
| 7 | -Vout |
| 8 | +Vout |
| 14 | NA |

NA - Not available for electrical connection.

Recommended Footprint Details

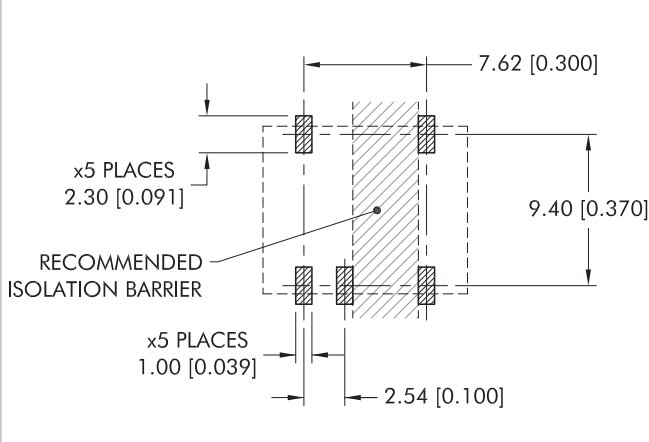

TAPE & REEL SPECIFICATIONS

REEL OUTLINE DIMENSIONS

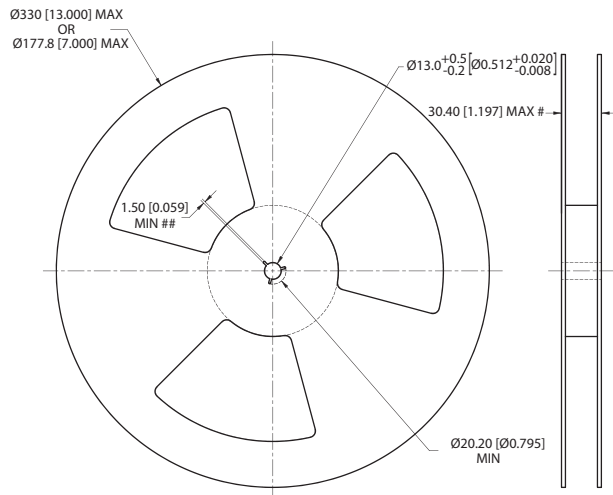

Tape & Reel specifications shall conform with current EIA-481 standard
 Unless otherwise stated all dimensions in mm(inches)
 Controlling dimension is mm
 # Measured at hub
 ## Six equi-spaced slots on 180mm/7" reel

REEL PACKAGING DETAILS

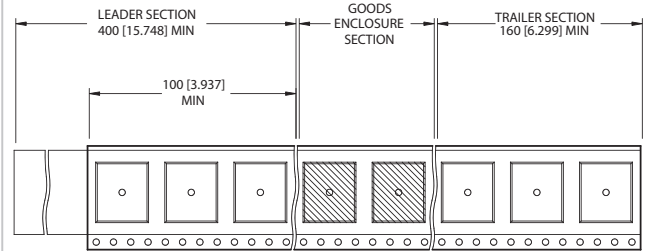

Carrier tape pockets shown are illustrative only - Refer to carrier tape diagram for actual pocket details.
 Reel Quantity: 7" - 180 or 13" - 800

TAPE OUTLINE DIMENSIONS

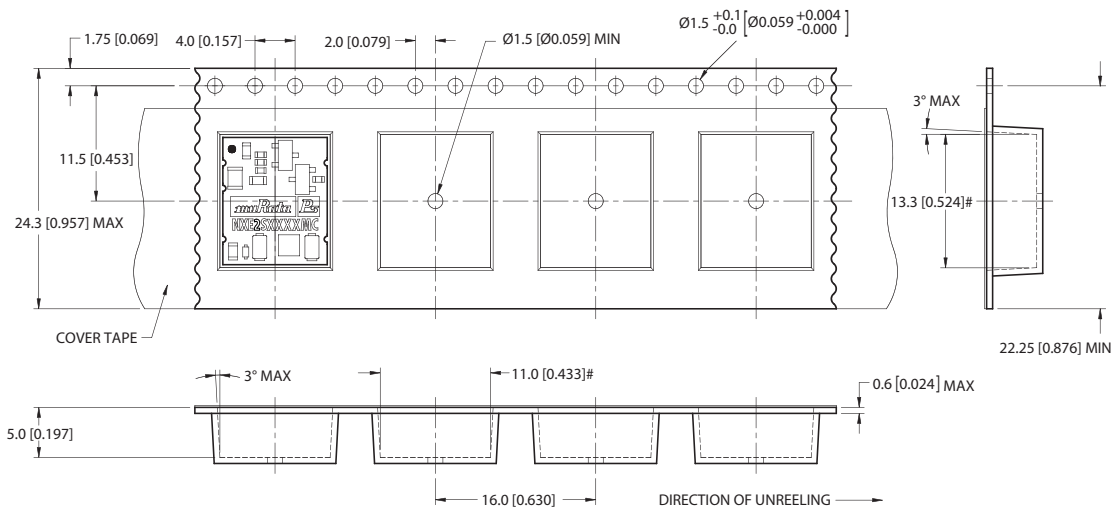

Tape & Reel specifications shall conform with current EIA-481 standard
 Unless otherwise stated all dimensions in mm(inches) ±0.1mm (±0.004 Inches)
 Controlling dimension is mm
 Components shall be orientated within the carrier tape as indicated
 # Measured on a plane 0.3mm above the bottom pocket

DISCLAIMER

Unless otherwise stated in the datasheet, all products are designed for standard commercial and industrial applications and NOT for safety-critical and/or life-critical applications.

Particularly for safety-critical and/or life-critical applications, i.e. applications that may directly endanger or cause the loss of life, inflict bodily harm and/or loss or severe damage to equipment/property, and severely harm the environment, a prior explicit written approval from Murata is strictly required. Any use of Murata standard products for any safety-critical, life-critical or any related applications without any prior explicit written approval from Murata shall be deemed unauthorised use.

These applications include but are not limited to:

- Aircraft equipment
- Aerospace equipment
- Undersea equipment
- Power plant control equipment
- Medical equipment
- Transportation equipment (automobiles, trains, ships, etc.)
- Traffic signal equipment
- Disaster prevention / crime prevention equipment
- Data Processing equipment

Murata makes no express or implied warranty, representation, or guarantee of suitability, fitness for any particular use/purpose and/or compatibility with any application or device of the buyer, nor does Murata assume any liability whatsoever arising out of unauthorised use of any Murata product for the application of the buyer. The suitability, fitness for any particular use/purpose and/or compatibility of Murata product with any application or device of the buyer remain to be the responsibility and liability of the buyer.

Buyer represents and agrees that it has all the necessary expertise to create and implement safeguards that anticipate dangerous consequences of failures, monitor failures and their consequences, lessen the likelihood of failures that might cause harm, and take appropriate remedial actions. Buyer will fully indemnify and hold Murata, its affiliated companies, and its representatives harmless against any damages arising out of unauthorised use of any Murata products in any safety-critical and/or life-critical applications.

Remark: Murata in this section refers to Murata Manufacturing Company and its affiliated companies worldwide including, but not limited to, Murata Power Solutions.



This product is subject to the following [operating requirements](https://www.murata.com/en-eu/products/power/requirements) and the [Life and Safety Critical Application Sales Policy](https://www.murata.com/en-eu/products/power/requirements):

Refer to: <https://www.murata.com/en-eu/products/power/requirements>

Murata Power Solutions (Milton Keynes) Ltd. makes no representation that the use of its products in the circuits described herein, or the use of other technical information contained herein, will not infringe upon existing or future patent rights. The descriptions contained herein do not imply the granting of licenses to make, use, or sell equipment constructed in accordance therewith. Specifications are subject to change without notice.

© 2021 Murata Power Solutions (Milton Keynes) Ltd.