



3-terminal filters

For signal line

YFF-SC series

YFF15SC	1005 [0402 inch]*	Feed through filter
YFF18SC	1608 [0603 inch]	Feed through filter
YFF21SC	2012 [0805 inch]	Feed through filter

* Dimensions Code JIS[EIA]

3-terminal filters

For signal line

Product compatible with RoHS directive
Compatible with lead-free solders

Overview of the YFF-SC series

FEATURES

- Small and high-performance EMC components.
- Good attenuation characteristic in high frequency ranges.

APPLICATION

High impedance circuits, e.g. digital signal circuits.
I/O interface sections of devices with electric circuits and the area around connectors.
Low-current power line of communication terminal devices, AV, and information devices.

PART NUMBER CONSTRUCTION

YFF		21		SC		1E		473		M		T		□□		0		N	
Series name	L x W dimensions		Product internal code		Rated voltage		Capacitance		Tolerance		Taping	TDK internal code	Reel size		Internal electrode Ni				
	Code	mm	Code	Signal line	Code	V	Code	pF	M	±20%			Code	mm	Code	mm			
	15	1.0x0.5	SC	Signal line	1C	16	220	22					0	ø178					
	18	1.6x0.8			1E	25	101	100					9	ø330					
	21	2.0x1.2			1H	50	221	220											
							473	47,000 (47nF)											

OPERATING TEMPERATURE RANGE, PACKAGE QUANTITY, PRODUCT WEIGHT

Type	Package quantity (piece/reel)		Individual weight (g)
	ø178	ø330	
YFF15SC	10,000	50,000	0.0008
YFF18SC	4,000	10,000	0.0038
YFF21SC	4,000	10,000	0.0095

* The storage temperature range is for after the assembly.

- Conformity to RoHS directive: this means that, in conformity with EU directive 2011/65/EC, lead, cadmium, mercury, hexavalent chromium, and specific bromine-based flame retardants, PBB and PBDE, have not been used, except for exempted applications.
- Please contact our Sales office when your application is considered the following: The device's failure or malfunction may directly endanger human life (e.g. application for automobile/aircraft/medical/nuclear power devices, etc.)

 Please be sure to request delivery specifications that provide further details on the features and specifications of the products for proper and safe use. Please note that the contents may change without any prior notice due to reasons such as upgrading.

Overview of the YFF-SC series

RECOMMENDED SOLDERING CONDITION

REFLOW SOLDERING

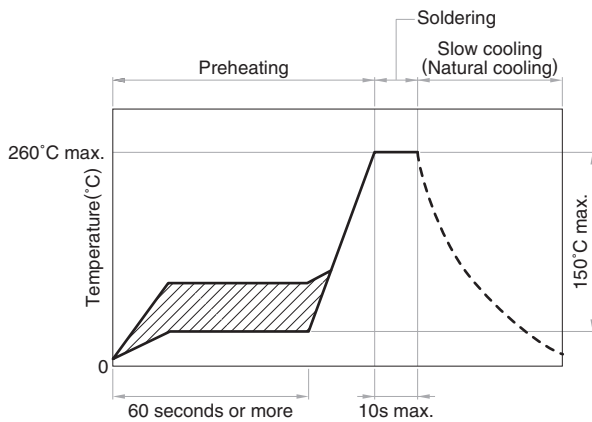

HAND SOLDERING

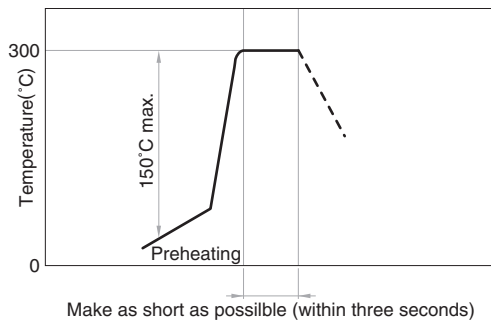

REMINDERS FOR USING THESE PRODUCTS

- Before soldering, be sure to preheat components. The ΔT preheating temperature must be 150°C max. with attention paid to thermal shock.
- Natural cooling of components in the air is recommended. On the other hand, when dipping them in a solvent for purposes, such as cleaning, make sure that the temperature difference (ΔT) is 100°C.
- When performing hand soldering for circuit modification, apply the soldering iron to the copper foil area of the printed circuit board for 3 seconds or less. The temperature of the iron tip should not exceed 300°C.
- Use a wrist band to discharge static electricity in your body through the grounding wire.
- When incorporating the printed circuit board on which this product is mounted into a frame, etc., do not apply stress to the product through local bending of the board by tightening of screws, etc.

YFF-SC series YFF15SC type (Feed through filter)

SHAPE & DIMENSIONS

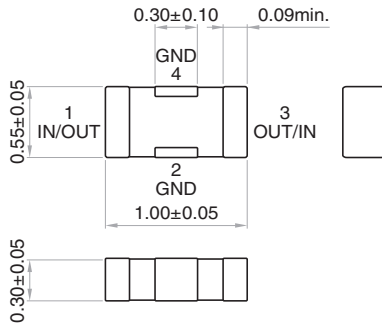

RECOMMENDED LAND PATTERN

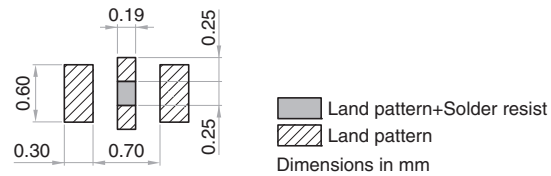

* Make sure to connect the GND terminal of this product and the GND of the mounting circuit board by using through holes so that the distance between them is the shortest.

ELECTRICAL CHARACTERISTICS

CHARACTERISTICS SPECIFICATION TABLE

Cutoff frequency (MHz)	Insertion loss 30dB bandwidth (MHz)	Rated voltage Edc (V)	Rated current Idc (A)	Operating temperature range (°C)	Storage temperature range (After mount) (°C)	Part No.*
0.1	5 to 4000	16	1	-55 to +125	-55 to +125	YFF15SC1C473MT000N
0.1	5 to 4000	16	1	-55 to +125	-55 to +125	YFF15SC1C473MT009N
0.3	10 to 4000	16	1	-55 to +125	-55 to +125	YFF15SC1C223MT000N
0.3	10 to 4000	16	1	-55 to +125	-55 to +125	YFF15SC1C223MT009N
0.6	20 to 4000	25	1	-55 to +125	-55 to +125	YFF15SC1E103MT000N
0.6	20 to 4000	25	1	-55 to +125	-55 to +125	YFF15SC1E103MT009N
1	50 to 4000	25	1	-55 to +125	-55 to +125	YFF15SC1E472MT000N
1	50 to 4000	25	1	-55 to +125	-55 to +125	YFF15SC1E472MT009N
3	100 to 4000	25	1	-55 to +125	-55 to +125	YFF15SC1E222MT000N
3	100 to 4000	25	1	-55 to +125	-55 to +125	YFF15SC1E222MT009N
6	200 to 4000	25	1	-55 to +125	-55 to +125	YFF15SC1E102MT000N
6	200 to 4000	25	1	-55 to +125	-55 to +125	YFF15SC1E102MT009N
10	600 to 4000	25	1	-55 to +125	-55 to +125	YFF15SC1E471MT000N
10	600 to 4000	25	1	-55 to +125	-55 to +125	YFF15SC1E471MT009N
30	800 to 6000	50	1	-55 to +125	-55 to +125	YFF15SC1H221MT000N
30	800 to 6000	50	1	-55 to +125	-55 to +125	YFF15SC1H221MT009N
60	1500 to 6000	50	1	-55 to +125	-55 to +125	YFF15SC1H101MT000N
60	1500 to 6000	50	1	-55 to +125	-55 to +125	YFF15SC1H101MT009N
100	2000 to 6000	50	1	-55 to +125	-55 to +125	YFF15SC1H470MT000N
100	2000 to 6000	50	1	-55 to +125	-55 to +125	YFF15SC1H470MT009N
300	4000 to 6000	50	1	-55 to +125	-55 to +125	YFF15SC1H220MT000N
300	4000 to 6000	50	1	-55 to +125	-55 to +125	YFF15SC1H220MT009N

* The part numbers are TDK's standard specification products.

⚠ Please be sure to request delivery specifications that provide further details on the features and specifications of the products for proper and safe use. Please note that the contents may change without any prior notice due to reasons such as upgrading.

YFF-SC series YFF15SC type (Feed through filter)

- ELECTRICAL CHARACTERISTICS GRAPH (EXAMPLE)
- INSERTION LOSS VS. FREQUENCY CHARACTERISTICS

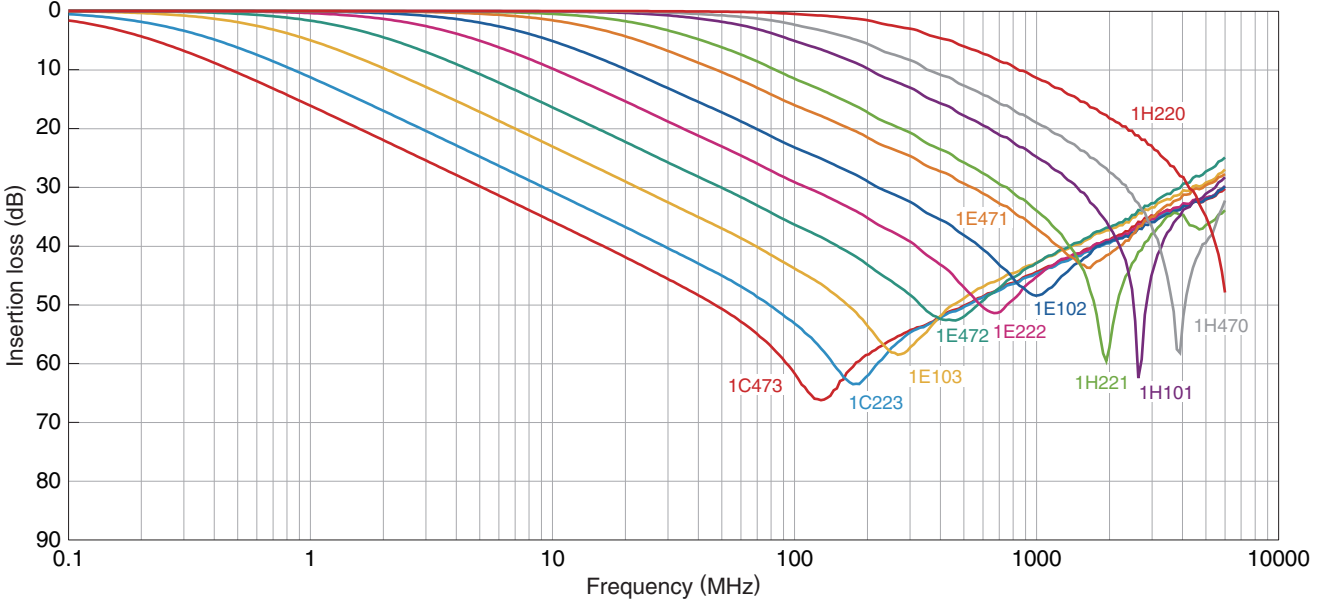

 Please be sure to request delivery specifications that provide further details on the features and specifications of the products for proper and safe use. Please note that the contents may change without any prior notice due to reasons such as upgrading.

YFF-SC series YFF18SC type (Feed through filter)

SHAPE & DIMENSIONS

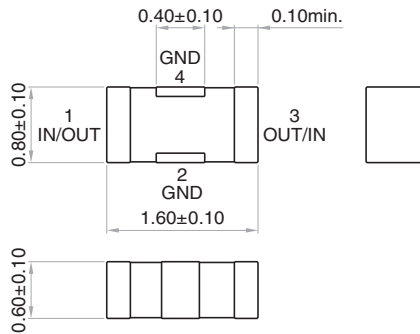

RECOMMENDED LAND PATTERN

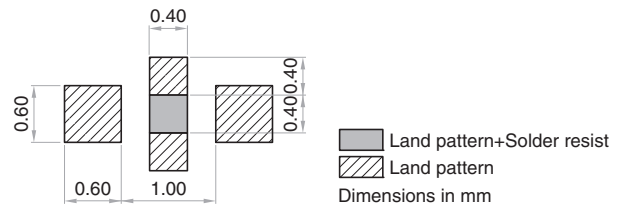

* Make sure to connect the GND terminal of this product and the GND of the mounting circuit board by using through holes so that the distance between them is the shortest.

ELECTRICAL CHARACTERISTICS

CHARACTERISTICS SPECIFICATION TABLE

Cutoff frequency (MHz)	Insertion loss 30dB bandwidth (MHz)	Rated voltage Edc (V)	Rated current Idc (A)	Operating temperature range (°C)	Storage temperature range (After mount) (°C)	Part No.*
0.3	10 to 3000	50	1	-55 to +125	-55 to +125	YFF18SC1H223MT0H0N
0.3	10 to 3000	50	1	-55 to +125	-55 to +125	YFF18SC1H223MT0H9N
0.6	20 to 3000	50	1	-55 to +125	-55 to +125	YFF18SC1H103MT0H0N
0.6	20 to 3000	50	1	-55 to +125	-55 to +125	YFF18SC1H103MT0H9N
1	40 to 3000	50	1	-55 to +125	-55 to +125	YFF18SC1H472MT0H0N
1	40 to 3000	50	1	-55 to +125	-55 to +125	YFF18SC1H472MT0H9N
2	90 to 3000	50	1	-55 to +125	-55 to +125	YFF18SC1H222MT0H0N
2	90 to 3000	50	1	-55 to +125	-55 to +125	YFF18SC1H222MT0H9N
6	200 to 3000	50	1	-55 to +125	-55 to +125	YFF18SC1H102MT0H0N
6	200 to 3000	50	1	-55 to +125	-55 to +125	YFF18SC1H102MT0H9N
10	400 to 6000	50	1	-55 to +125	-55 to +125	YFF18SC1H471MT0H0N
10	400 to 6000	50	1	-55 to +125	-55 to +125	YFF18SC1H471MT0H9N
20	800 to 6000	50	1	-55 to +125	-55 to +125	YFF18SC1H221MT0H0N
20	800 to 6000	50	1	-55 to +125	-55 to +125	YFF18SC1H221MT0H9N
60	1500 to 6000	50	1	-55 to +125	-55 to +125	YFF18SC1H101MT0H0N
60	1500 to 6000	50	1	-55 to +125	-55 to +125	YFF18SC1H101MT0H9N
100	2000 to 6000	50	1	-55 to +125	-55 to +125	YFF18SC1H470MT0H0N
100	2000 to 6000	50	1	-55 to +125	-55 to +125	YFF18SC1H470MT0H9N
200	4000 to 6000	50	1	-55 to +125	-55 to +125	YFF18SC1H220MT0H0N
200	4000 to 6000	50	1	-55 to +125	-55 to +125	YFF18SC1H220MT0H9N

* The part numbers are TDK's standard specification products.

YFF-SC series YFF18SC type (Feed through filter)

- ELECTRICAL CHARACTERISTICS GRAPH (EXAMPLE)
- INSERTION LOSS VS. FREQUENCY CHARACTERISTICS

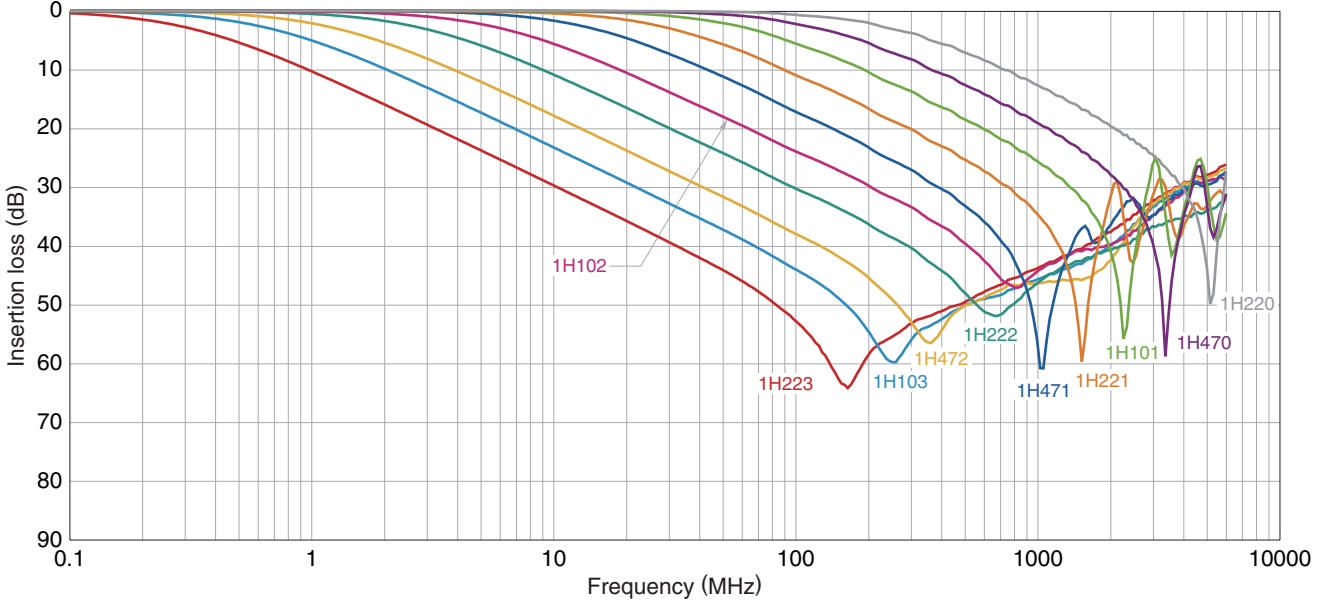

Please be sure to request delivery specifications that provide further details on the features and specifications of the products for proper and safe use. Please note that the contents may change without any prior notice due to reasons such as upgrading.

YFF-SC series YFF21SC type (Feed through filter)

SHAPE & DIMENSIONS

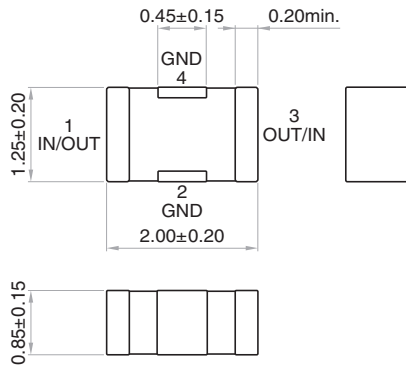

RECOMMENDED LAND PATTERN

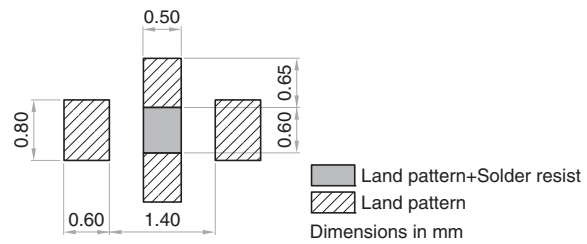

* Make sure to connect the GND terminal of this product and the GND of the mounting circuit board by using through holes so that the distance between them is the shortest.

ELECTRICAL CHARACTERISTICS

CHARACTERISTICS SPECIFICATION TABLE

Cutoff frequency (MHz)	Insertion loss 30dB bandwidth (MHz)	Rated voltage Edc (V)	Rated current Idc (A)	Operating temperature range (°C)	Storage temperature range (After mount) (°C)	Part No.*
0.1	5 to 2000	50	2	-55 to +125	-55 to +125	YFF21SC1H473MT000N
0.1	5 to 2000	50	2	-55 to +125	-55 to +125	YFF21SC1H473MT009N
0.1	5 to 2000	25	2	-55 to +125	-55 to +125	YFF21SC1E473MT000N
0.1	5 to 2000	25	2	-55 to +125	-55 to +125	YFF21SC1E473MT009N
0.2	10 to 2000	50	2	-55 to +125	-55 to +125	YFF21SC1H223MT000N
0.2	10 to 2000	50	2	-55 to +125	-55 to +125	YFF21SC1H223MT009N
0.2	10 to 2000	25	2	-55 to +125	-55 to +125	YFF21SC1E223MT000N
0.2	10 to 2000	25	2	-55 to +125	-55 to +125	YFF21SC1E223MT009N
0.5	20 to 2000	25	1	-55 to +125	-55 to +125	YFF21SC1E103MT000N
0.5	20 to 2000	25	1	-55 to +125	-55 to +125	YFF21SC1E103MT009N
1	40 to 2000	50	0.4	-55 to +125	-55 to +125	YFF21SC1H472MT000N
1	40 to 2000	50	0.4	-55 to +125	-55 to +125	YFF21SC1H472MT009N
2	70 to 2000	50	0.4	-55 to +125	-55 to +125	YFF21SC1H222MT000N
2	70 to 2000	50	0.4	-55 to +125	-55 to +125	YFF21SC1H222MT009N
5	200 to 2000	50	0.4	-55 to +125	-55 to +125	YFF21SC1H102MT000N
5	200 to 2000	50	0.4	-55 to +125	-55 to +125	YFF21SC1H102MT009N
10	400 to 5000	50	0.4	-55 to +125	-55 to +125	YFF21SC1H471MT000N
10	400 to 5000	50	0.4	-55 to +125	-55 to +125	YFF21SC1H471MT009N
20	700 to 5000	50	0.4	-55 to +125	-55 to +125	YFF21SC1H221MT000N
20	700 to 5000	50	0.4	-55 to +125	-55 to +125	YFF21SC1H221MT009N
50	1000 to 5000	50	0.4	-55 to +125	-55 to +125	YFF21SC1H101MT000N
50	1000 to 5000	50	0.4	-55 to +125	-55 to +125	YFF21SC1H101MT009N
100	2000 to 5000	50	0.4	-55 to +125	-55 to +125	YFF21SC1H470MT000N
100	2000 to 5000	50	0.4	-55 to +125	-55 to +125	YFF21SC1H470MT009N
200	3000 to 5000	50	0.4	-55 to +125	-55 to +125	YFF21SC1H220MT000N
200	3000 to 5000	50	0.4	-55 to +125	-55 to +125	YFF21SC1H220MT009N

* The part numbers are TDK's standard specification products.

Background red: The product which is planning to stop production

⚠ Please be sure to request delivery specifications that provide further details on the features and specifications of the products for proper and safe use. Please note that the contents may change without any prior notice due to reasons such as upgrading.

YFF-SC series YFF21SC type (Feed through filter)

ELECTRICAL CHARACTERISTICS GRAPH
INSERTION LOSS VS. FREQUENCY CHARACTERISTICS

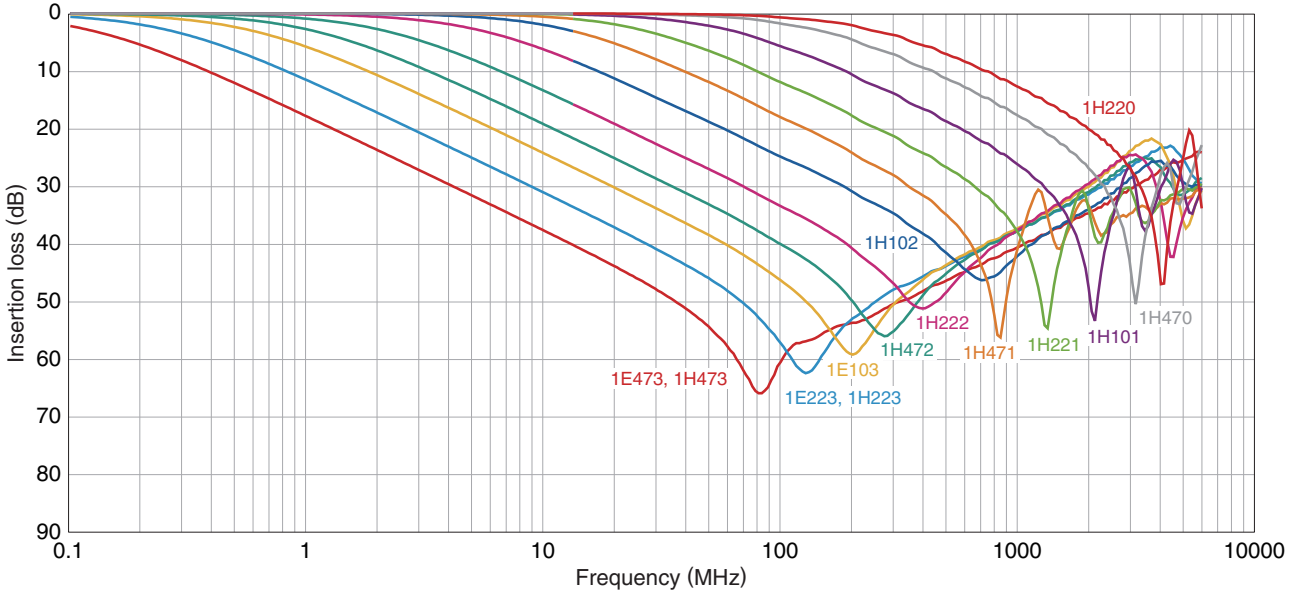

 Please be sure to request delivery specifications that provide further details on the features and specifications of the products for proper and safe use. Please note that the contents may change without any prior notice due to reasons such as upgrading.

YFF-SC series Packaging style

REEL DIMENSIONS

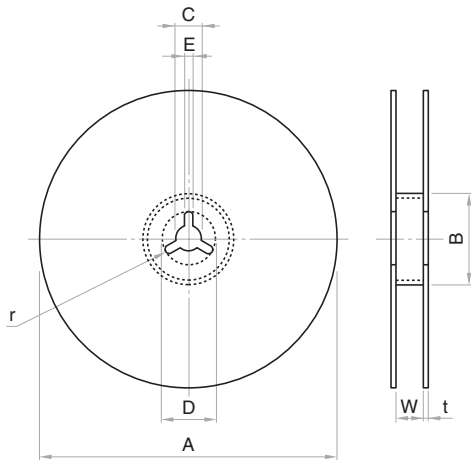

Unit: mm

Reel	A	B	C	D	E	W	t	r
ø178	ø178±2.0	ø60±2.0	ø13±0.5	ø21±0.8	2.0±0.5	9.0±0.3	2.0±0.5	1.0
ø330	ø382 max.(ø330 nom.)	ø50 min.	ø13±0.5	ø21±0.8	2.0±0.5	10.0±1.5	2.0±0.5	1.0

TAPE DIMENSIONS

Paper tape

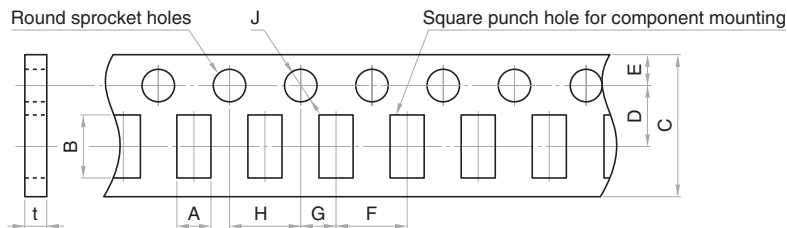

Unit: mm

Type	A	B	C	D	E	F	G	H	J	t
YFF15SC	0.62 typ.	1.12 typ.	8.0±0.3	3.5±0.05	1.75±0.1	2.0±0.05	2.0±0.05	4.0±0.1	ø1.5+0.1/-0	0.7 max.
YFF18SC	1.10 typ.	1.90 typ.	8.0±0.3	3.5±0.05	1.75±0.1	4.0±0.1	2.0±0.05	4.0±0.1	ø1.5+0.1/-0	1.1 max.
YFF21SC	1.50 typ.	2.3 typ.	8.0±0.3	3.5±0.05	1.75±0.1	4.0±0.1	2.0±0.05	4.0±0.1	ø1.5+0.1/-0	1.1 max.

⚠ Please be sure to request delivery specifications that provide further details on the features and specifications of the products for proper and safe use. Please note that the contents may change without any prior notice due to reasons such as upgrading.