

GaAs MMIC LOW NOISE AMPLIFIER, 3.5 - 8.0 GHz

Typical Applications

The HMC392ALC4 is ideal for:

- Point-to-Point Radios
- VSAT
- LO Driver for HMC Mixers
- Military EW, ECM, C³I
- Space

Features

- Gain: 17 dB
- Noise Figure: 1.8 dB
- Single Supply Voltage: +2V to +5V
- No External Matching Components Required
- 50 Ohm Matched Input/Output
- RoHS Compliant 4x4 mm SMT Package

Functional Diagram

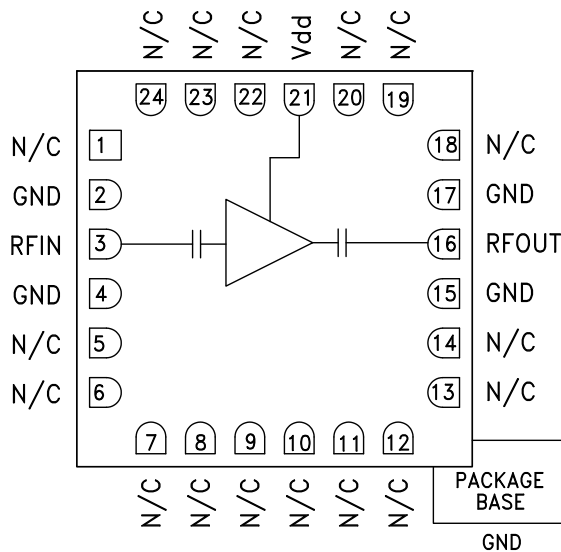

General Description

The HMC392ALC4 is a GaAs MMIC Low Noise Amplifier which operates between 3.5 and 8.0 GHz. Housed in a leadless 4x4 mm SMT package, this amplifier provides 17 dB of gain, 1.8 dB noise figure and 34.5 dBm IP3 from a +5V supply voltage. HMC392ALC4 functions well as a low noise front end or as a driver amplifier. The RF Input and Output pins are DC blocked and matched to 50 Ohms for ease of use. The HMC392ALC4 allows the use of surface mount manufacturing techniques and is suitable for high reliability military, industrial and space applications.

Electrical Specifications, $T_A = +25^\circ \text{C}$, $V_{dd} = +5V$

Parameter	Min.	Typ.	Max.	Units
Frequency Range	3.5 - 8.0			GHz
Gain	14.5	17		dB
Gain Variation Over Temperature		0.006	0.01	dB/ °C
Input Return Loss		13		dB
Output Return Loss		15		dB
Output Power for 1 dB Compression (P1dB)	16	19		dBm
Saturated Output Power (P _{sat})		20		dBm
Output Third Order Intercept (IP3)		34.5		dBm
Noise Figure		1.8	3	dB
Supply Current (I _{dd})	35	61	75	mA
Supply Voltage (V _{dd})	2	5	5.5	V

Information furnished by Analog Devices is believed to be accurate and reliable. However, no responsibility is assumed by Analog Devices for its use, nor for any infringements of patents or other rights of third parties that may result from its use. Specifications subject to change without notice. No license is granted by implication or otherwise under any patent or patent rights of Analog Devices. Trademarks and registered trademarks are the property of their respective owners.

For price, delivery, and to place orders: Analog Devices, Inc., One Technology Way, P.O. Box 9106, Norwood, MA 02062-9106
 Phone: 781-329-4700 • Order online at www.analog.com
 Application Support: Phone: 1-800-ANALOG-D

GaAs MMIC LOW NOISE AMPLIFIER, 3.5 - 8.0 GHz

Broadband Gain & Return Loss @ Vdd = 5V

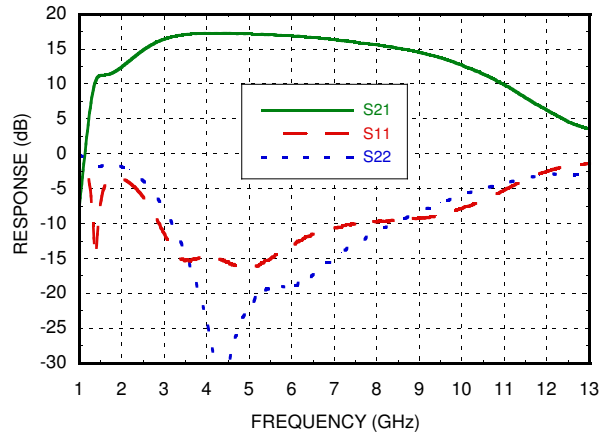

Broadband Gain vs. Supply Voltage

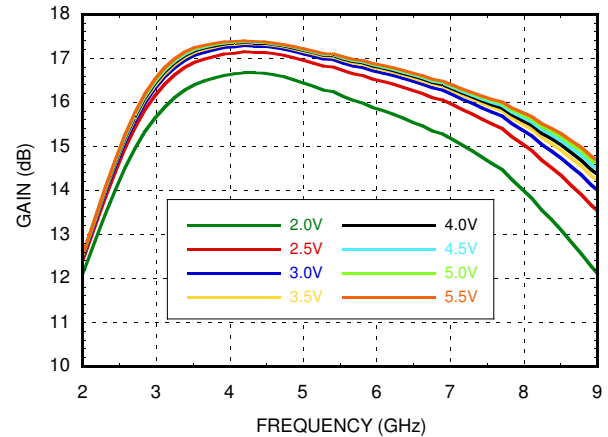

Gain vs. Temperature @ Vdd = 5V

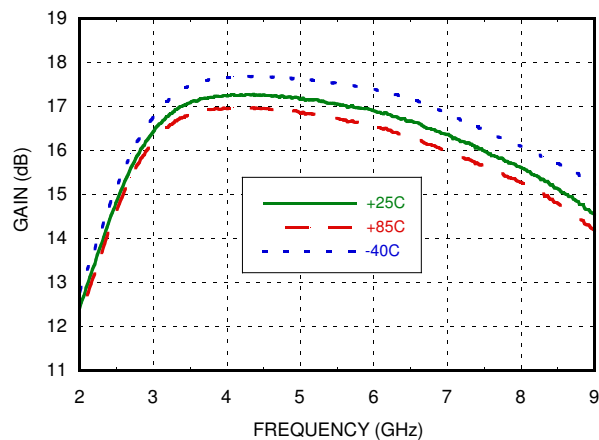

Input Return Loss vs. Temperature @ Vdd = 5V

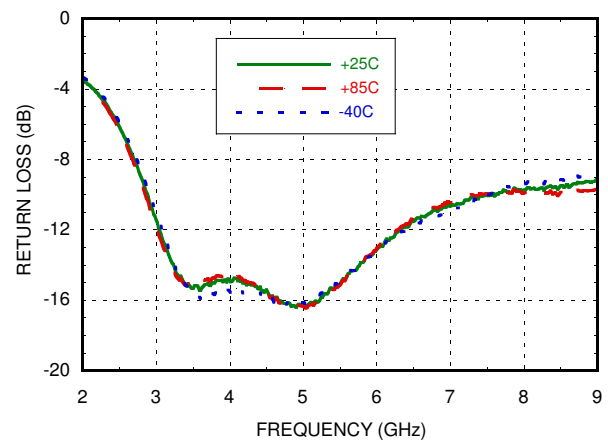

Input Return Loss vs. Supply Voltage

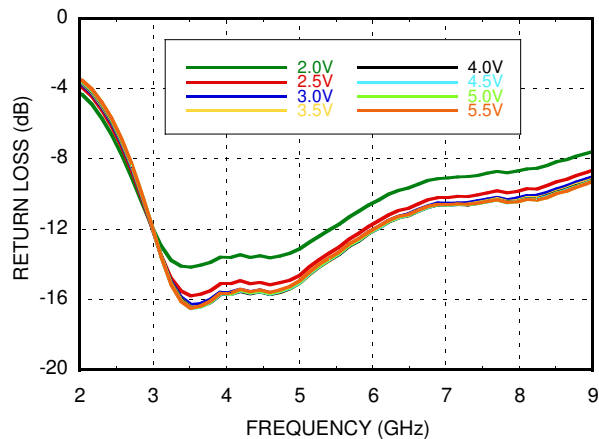

Output Return Loss vs. Temperature @ Vdd = 5V

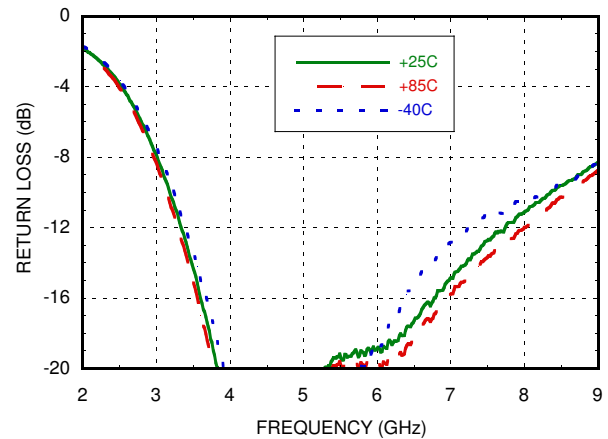

GaAs MMIC LOW NOISE AMPLIFIER, 3.5 - 8.0 GHz

AMPLIFIERS - LOW NOISE - SMT

Output Return Loss vs. Supply Voltage

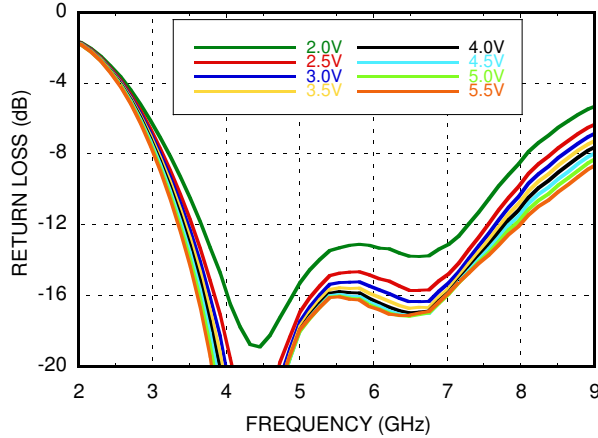

Noise Figure vs. Temperature @ Vdd = 5V

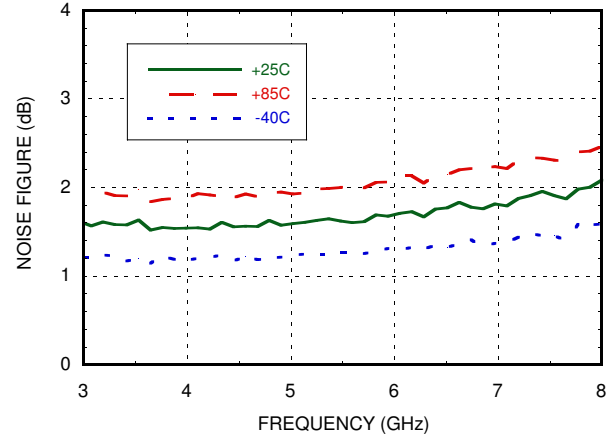

Noise Figure vs. Supply Voltage

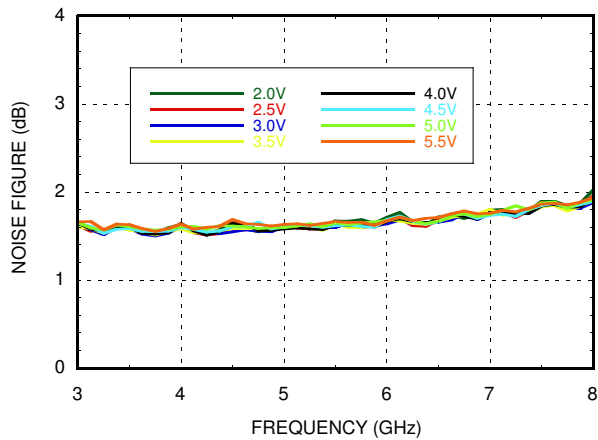

Reverse Isolation vs. Temperature @ Vdd = 5V

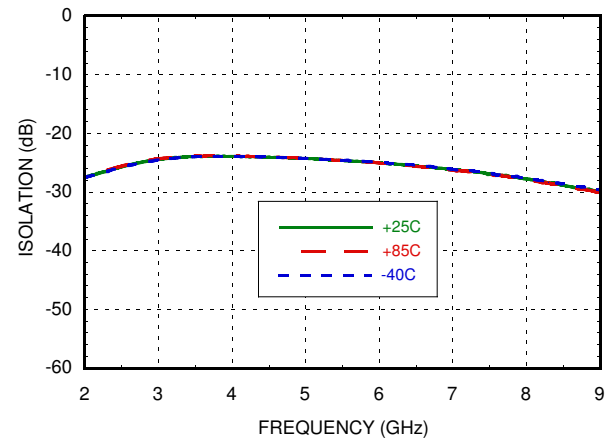

Reverse Isolation vs. Supply Voltage

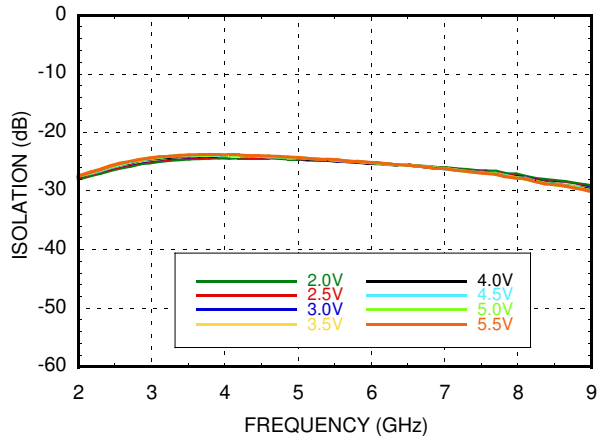

P1dB vs. Temperature @ Vdd = 5V

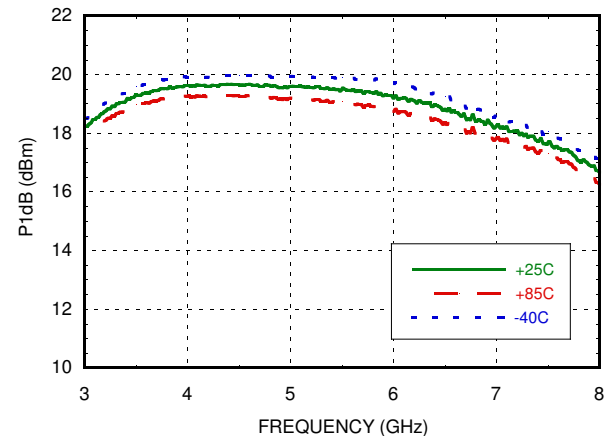

GaAs MMIC LOW NOISE AMPLIFIER, 3.5 - 8.0 GHz

P1dB vs. Supply Voltage

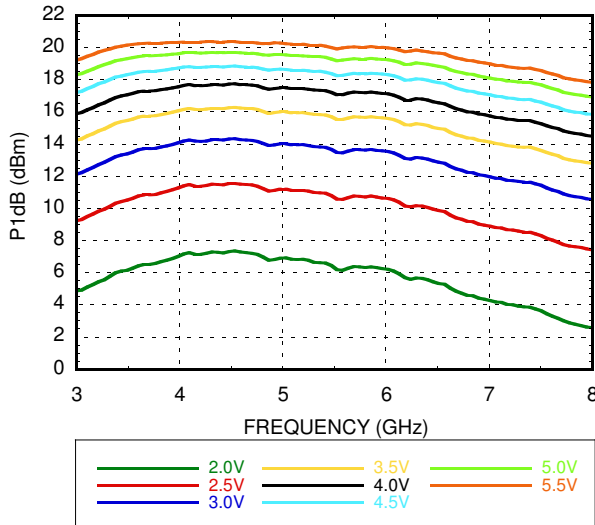

Psat vs. Temperature @ Vdd = 5V

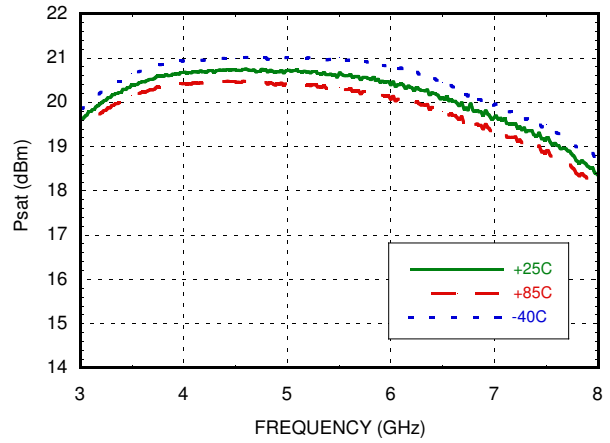

Psat vs. Supply Voltage

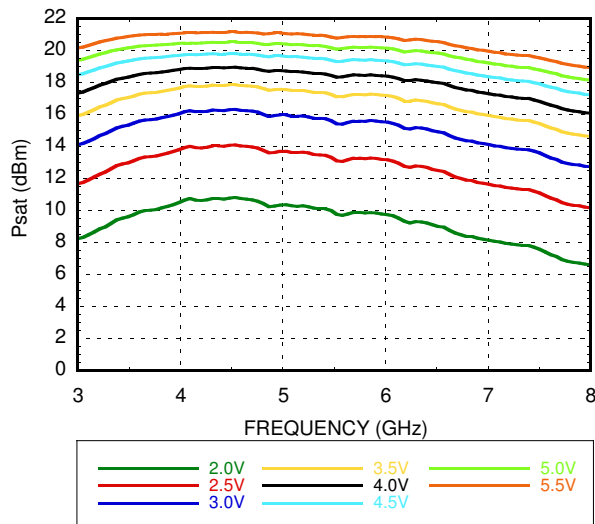

Output IP3 vs. Temperature @ Vdd = 5V

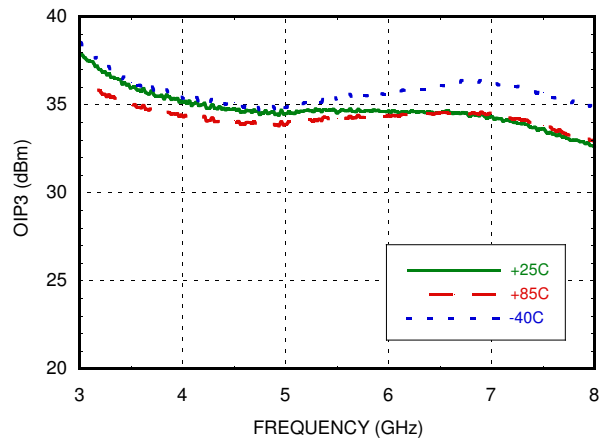

Output IP3 vs. Supply Voltage

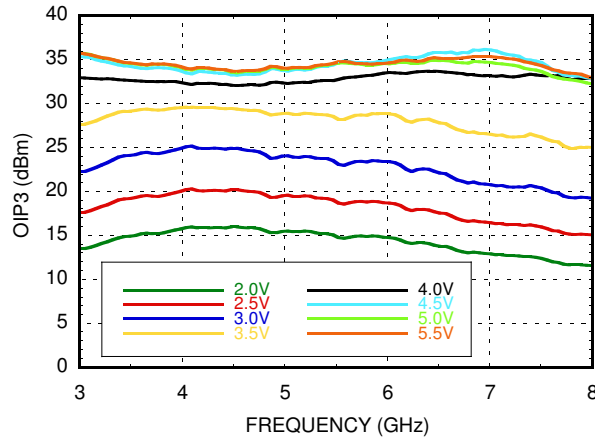

Idd vs. Supply Voltage

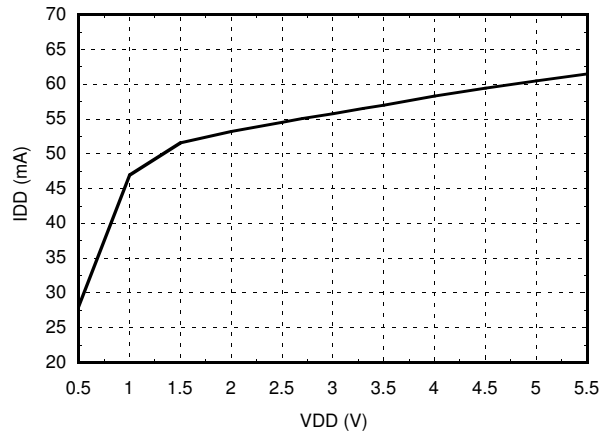

**GaAs MMIC LOW NOISE
AMPLIFIER, 3.5 - 8.0 GHz**

AMPLIFIERS - LOW NOISE - SMT

Power Compression @ 5.5GHz, Vdd = 5V

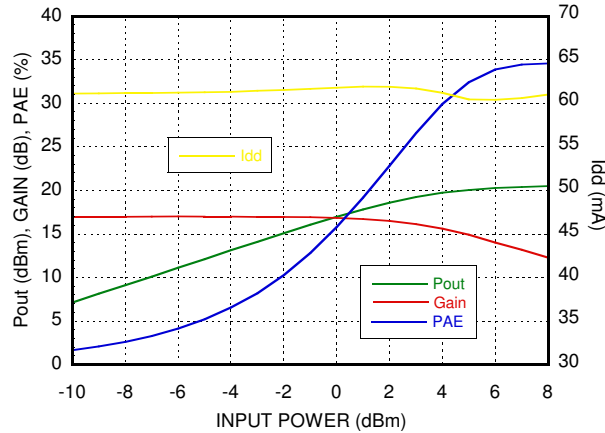

Gain, Noise Figure & Power vs. Supply Voltage @ 5.5 GHz

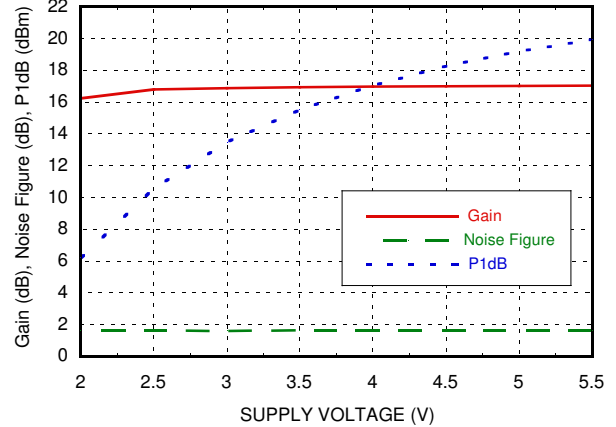

**GaAs MMIC LOW NOISE
AMPLIFIER, 3.5 - 8.0 GHz**
Absolute Maximum Ratings

Drain Bias Voltage (Vdd)	+7 Vdc
RF Input Power (RFIN)(Vdd = +5.0 Vdc)	+20 dBm
Channel Temperature	175 °C
Continuous P _{diss} (T= 85 °C) (derate 6.5 mW/°C above 85 °C)	0.66 W
Thermal Resistance (channel to ground paddle)	135.6 °C/W
Storage Temperature	-65 to +150 °C
Operating Temperature	-40 to +85 °C
ESD Rating	Class 1B - Passed 500V

Stresses at or above those listed under Absolute Maximum Ratings may cause permanent damage to the product. This is a stress rating only; functional operation of the product at these or any other conditions above those indicated in the operational section of this specification is not implied. Operation beyond the maximum operating conditions for extended periods may affect product reliability.

Typical Supply Current vs. Vdd

Vdd (V)	I _{dd} (mA)
+2.0	54
+2.5	55
+3.0	56
+3.5	57
+4.0	58
+4.5	60
+5.0	61
+5.5	62

Note: Amplifier will operate over full voltage ranges shown above.



**ELECTROSTATIC SENSITIVE DEVICE
OBSERVE HANDLING PRECAUTIONS**

GaAs MMIC LOW NOISE AMPLIFIER, 3.5 - 8.0 GHz

Outline Drawing



24-Terminal Ceramic Leadless Chip Carrier with [LCC]
(E-24-1)
Dimensions shown in millimeters.

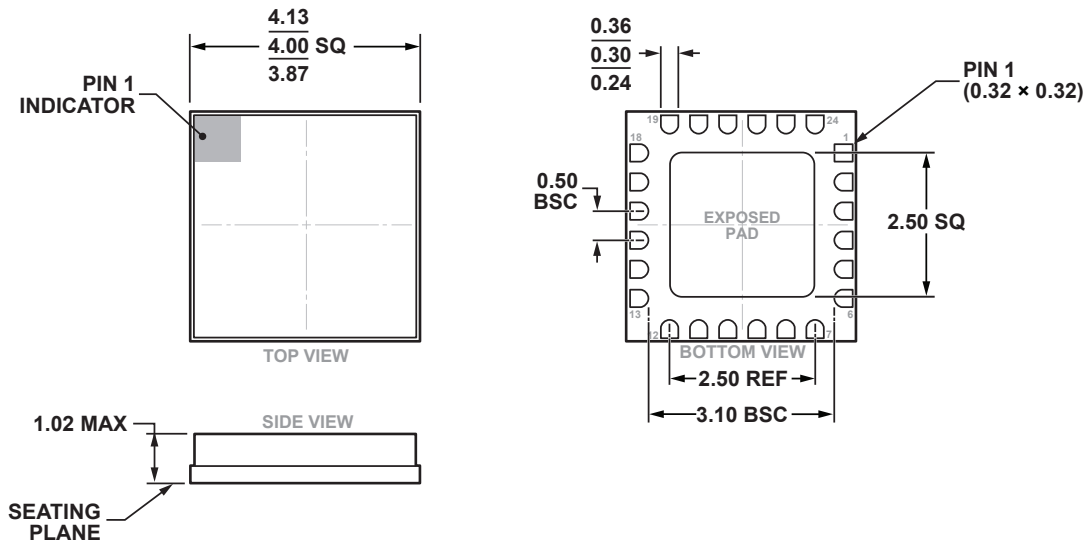

NOTES:

1. PACKAGE BODY MATERIAL: ALUMINA.
2. LEAD AND GROUND PADDLE PLATING: 30-80 MICROINCHES GOLD OVER 50 MICROINCHES MINIMUM NICKEL.
3. DIMENSIONS ARE IN INCHES (MILLIMETERS).
4. LEAD SPACING TOLERANCE IS NON-CUMULATIVE.
5. CHARACTERS TO BE HELVETICA MEDIUM, .025 HIGH, BLACK INK, OR LASER MARK LOCATED APPROX. AS SHOWN.
6. PACKAGE WARP SHALL NOT EXCEED 0.05MM DATUM $\overline{C-}$
7. ALL GROUND LEADS AND GROUND PADDLE MUST BE SOLDERED TO PCB RF GROUND.



Package Information

Pin Number	Package Body Material	Lead Finish	MSL Rating	Package Marking ^[2]
HMC392ALC4	Alumina, White	Gold over Nickel	MSL 3 ^[1]	H392A XXXX

[1] Max peak reflow temperature of 260 °C

[2] 4-Digit lot number XXXX

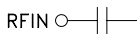
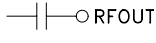
**GaAs MMIC LOW NOISE
AMPLIFIER, 3.5 - 8.0 GHz**
Pin Descriptions

Pin Number	Function	Description	Interface Schematic
1, 5 - 14, 18 - 20, 22 - 24	N/C	No connection required. These pins may be connected to RF/DC ground without affecting performance.	
2, 4, 15, 17	GND	Package bottom has an exposed metal paddle that must also be connected to RF/DC ground.	
3	RFIN	This pin is AC coupled and matched to 50 Ohms.	
16	RFOUT	This pin is AC coupled and matched to 50 Ohms.	
21	Vdd	Power Supply Voltage for the amplifier. External bypass capacitors of 100 pF, 1000pF, and 2.2 μF are required.	

THEORY OF OPERATIONS

The HMC392ALC4 is a GaAs MMIC low noise amplifier consisting of two stages in a cascode configuration with integrated RF chokes for the upper drain. The RFIN and RFOUT ports are DC blocked. Complete DC biasing is achieved through the use of a single supply. A simplified schematic view of the architecture is shown in Figure 3.

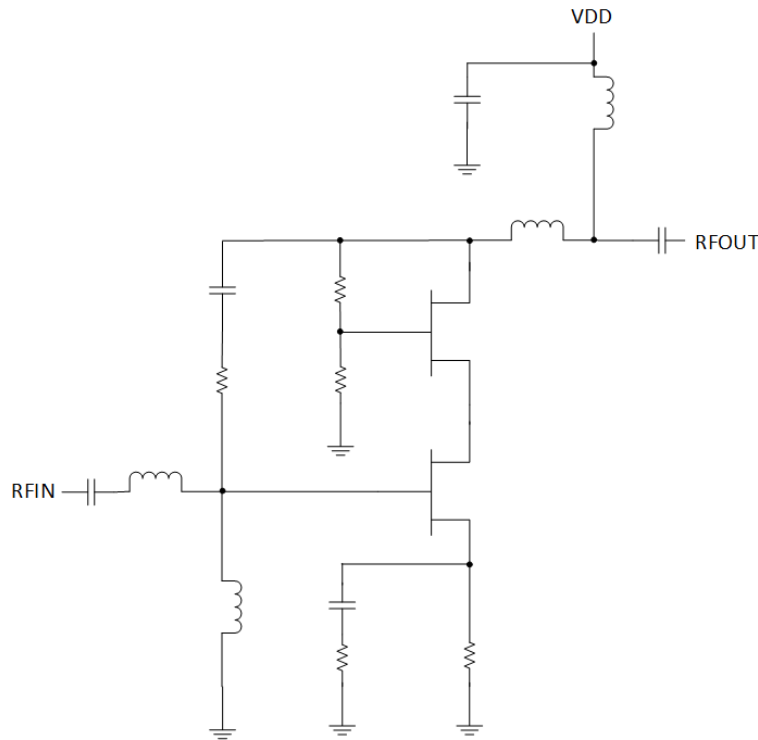

APPLICATIONS INFORMATION

Unless otherwise noted, all measurements and data shown on this datasheet were taken using the Typical Application Circuit as configured on the evaluation board. Capacitive bypassing is recommended for VDD, as shown in figure 4. The bias condition shown in the specifications section is the operating point recommended to optimize the overall performance. Operation using other bias conditions may provide performance that differs from what is shown in this datasheet. To avoid damage on the device, it is recommended that the RF signal be applied after the part has been DC biased and removed before the DC bias has been turned off.

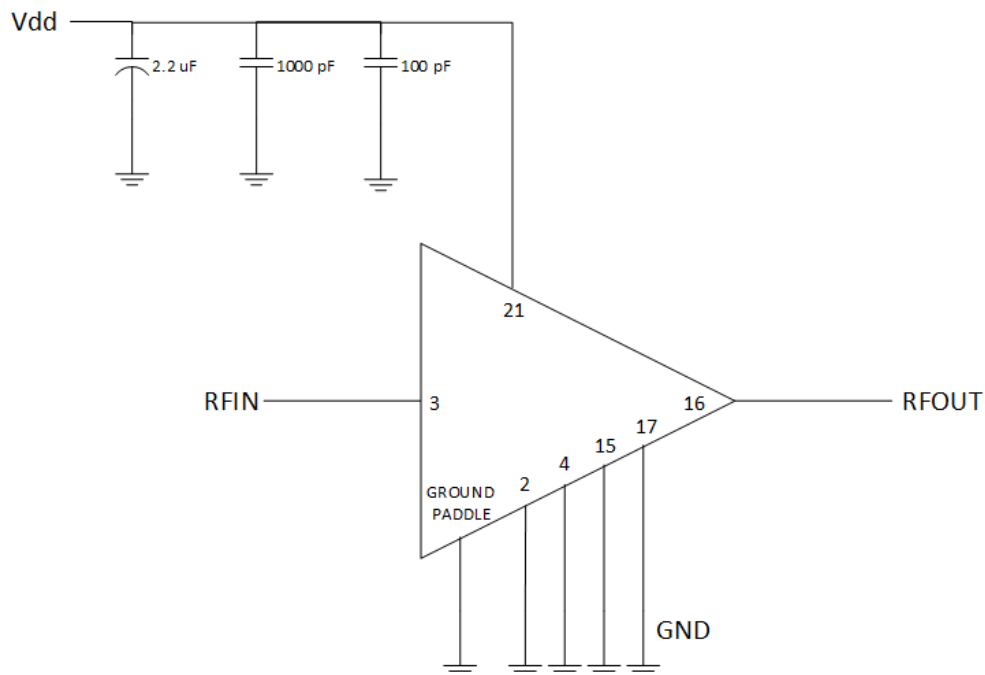

Evaluation PCB

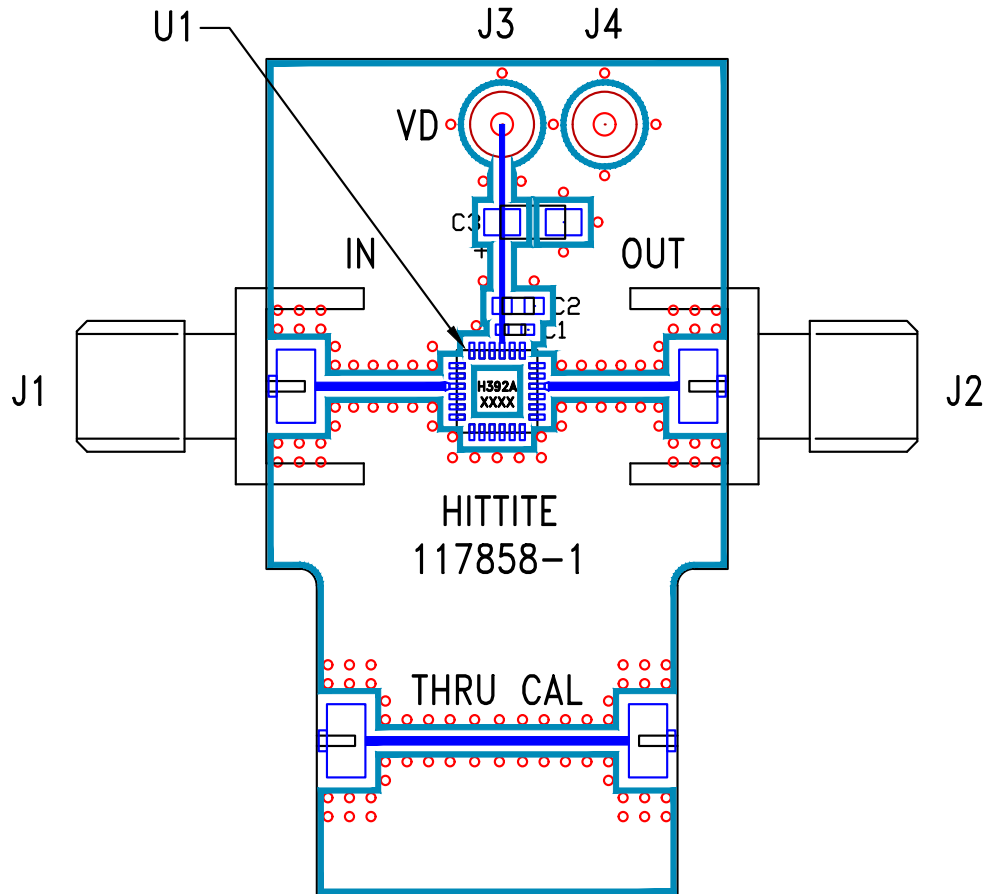

List of Materials for Evaluation PCB EV1HMC392ALC4 [1]

Item	Description
J1, J2	PCB mount SMA RF connectors, Johnson 142-0701-851
J3 - J4	DC Pin
C1	100 pF Capacitor, Ceramic, 50V, C0G, 0402 Pkg..
C2	1,000 pF Capacitor, Ceramic, 50V, X7R, 0603 Pkg..
C3	2.2µF Capacitor, Tantalum, 25V, 3216 Pkg
U1	HMC392ALC4 Amplifier
PCB [2]	117858 Evaluation PCB

[1] Reference this number when ordering complete evaluation PCB

[2] Circuit Board Material: Rogers 4350.

The circuit board used in this application should use RF circuit design techniques. Signal lines should have 50 Ohm impedance while the package ground leads and exposed paddle should be connected directly to the ground plane similar to that shown. A sufficient number of via holes should be used to connect the top and bottom ground planes. The evaluation board should be mounted to an appropriate heat sink. The evaluation circuit board shown is available from Analog Devices upon request.