



Choke Coils for PFC

Pin terminal type

PFC series

PFC3514QM
PFC3318QM
PFC3519QM
PFC3819QM
PFC4124QM
PFC2723ER
PFC3125ER
PFC3525ER
PFC3820QN
PFC3831QN

Dynamic characteristic data

- [PFC-QM series](#)
- [PFC-ER series](#)
- [PFC-QN series](#)

An attention matter on use

Please read this specifications before using this product by all means.

An attention matter on security

I undertake use with this product, and it is paid attention enough, and please design an attention matter safely.

Attention on a design

- When designing the board, use our recommended hole diameter or pad.
- Magnetic flux to leak out occurs. Please confirm it about influence of magnetic flux beforehand.
There is fear to cause false movement of machinery.
- When designing the board, ensure a distance from the transformer in accordance with the applicable safety standards.
- The product is not quakeproof structure. Accordingly please do not add vibration and a shock to it.
The product produces possibility to lose a function.

Attention on the handling

- Please do not use it when you let a product drop.
The product produces possibility to lose a function.
- Be careful not to get injured because the tip of the terminal is sharpened by soldering.
- For storage, avoid dust, dust, fog, water droplets and direct sunlight.
There is fear to cause false movement of machinery.
- Do not use or store in an environment with gas corrosion (salt, acid, alkali, etc.).
The product produces possibility to lose a function.
- When mounting, do not apply excessive force to the product with metal tools or the like.
The product produces possibility to lose a function.

Attention

- The structure and number of turns (magnetic mounting) are determined in consideration of safety standards, power supply voltage, circuit drive conditions (drive frequency and maximum ON period), etc., so avoid using them outside the design conditions.
There are destruction of a circuit part and fear of ignition.
- The operating temperature and humidity ranges are determined in consideration of the characteristics of the components and the self-temperature rise, so please avoid using in a range exceeding this range.
There is a risk of burning or ignition.
- Avoid using it in an environment where dust and dirt are likely to adhere.
There is a risk of cause a fire.
- The products listed on this specification sheet are intended for use in general electronic equipment (AV equipment, telecommunications equipment, home appliances, amusement equipment, computer equipment, personal equipment, office equipment, measurement equipment, industrial robots) under a normal operation and use condition.
- The products are not designed or warranted to meet the requirements of the applications listed below, whose performance and/or quality require a more stringent level of safety or reliability, or whose failure, malfunction or trouble could cause serious damage to society, person or property.
- Please note that we are not responsible for any damages caused by exceeding the scope and conditions of this specification or by using it for a specific purpose
- If you exceed the scope and conditions of this specification, or plan to use it for a specific purpose, please contact us in advance.
- We will discuss specifications other than those listed in this specification according to the customer's application.

- (1) Aerospace/Aviation equipment
- (2) Transportation equipment (cars, electric trains, ships, etc.)
- (3) Medical equipment
- (4) Power-generation control equipment
- (5) Atomic energy-related equipment
- (6) Seabed equipment applications
- (7) Transportation control equipment

- (8) Public information-processing equipment
- (9) Military equipment
- (10) Electric heating apparatus, burning equipment
- (11) Disaster prevention/crime prevention equipment
- (12) Safety equipment
- (13) Other applications that are not considered general-purpose applications

When designing your equipment even for general-purpose applications, you are kindly requested to take into consideration securing protection circuit/device or providing backup circuits in your equipment.

Choke Coils for PFC

PFC series

Contents	Page
Development Concept	4
Overview	5
PFC QM series	
PFC3514QM (Height from the board : 15.5mm)	6
PFC3318QM (Height from the board : 20mm)	8
PFC3519QM (Height from the board : 21mm)	10
PFC3819QM (Height from the board : 21mm)	12
PFC4124QM (Height from the board : 25mm)	14
PFC ER series	
PFC2723ER (Height from the board : 26mm)	16
PFC3125ER (Height from the board : 27mm)	18
PFC3525ER (Height from the board : 27mm)	20
PFC QN series	
PFC3820QN (Height from the board: 50mm Narrow floor space)	22
PFC3831QN (Height from the board: 50mm Narrow floor space)	24
Specification Request Form	26

Choke Coils for PFC

Pin terminal type

Development Concept of the PFC series

This is a power - factor improvement circuit for choke coils for smaller, thinner and narrow floor space in recent years electronic equipment.

■ MATERIAL

Thanks to the development of an optimized core shape and materials, the choke coil has DC superimposition characteristics suitable for the design of various types of electronic devices.

Optimized materials have been selected, and at the same time the original core shape for PFC has been developed.

The product line-up has been expanded to cater for various types of electronic devices that need to become smaller, thinner and narrow floor space.

■ MANUFACTURING METHOD

Since the PFC Series supports automatic winding, the product is of a high quality and can be manufactured stably.

It is designed to support automatic winding, which enables a remarkable reduction in the loss generated to achieve a proficient in manual winding until stable production.

In addition, the characteristic variations of the winding wire and creepage tape have largely been removed, stabilizing the transformer's characteristics.

■ OPTIMIZATION DESIGN

While the existing line-up of standard products remains available, new products can also be manufactured to meet customers' requests. Using design tools developed with TDK's comprehensive know-how, high-precision design has been achieved in a short period of time.

- 1) For optimization design and high-quality stable production, customers can use a specification request form.
If you provide the necessary information in the form, you will receive the optimization design in a short time.
- 2) TDK recommends design with a standard core gap (AL-value) for optimization and shorter trial and mass production lead time.

■ ENVIRONMENT

The PFC series is RoHS directive-compliant product.

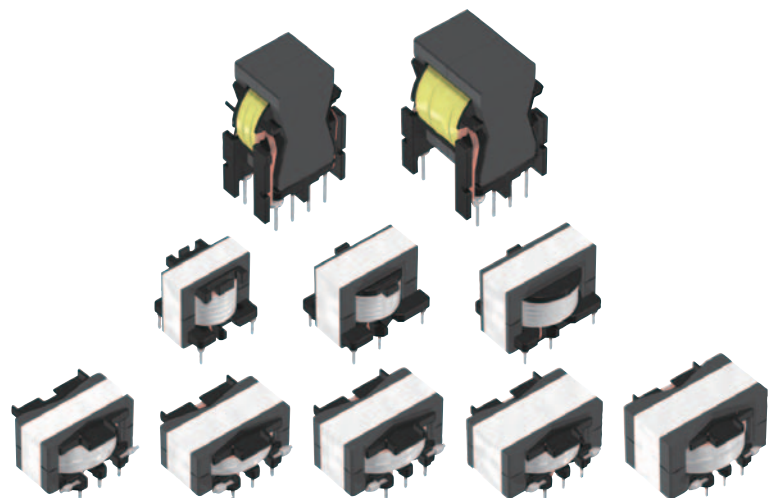

Choke Coils for PFC

Product compatible with RoHS directive
Compatible with lead-free solders

Pin terminal type

Overview of the PFC series

FEATURES

- A low height(15.5 to 27mm in height) and narrow floor space(QN type) are achieved.
- Large current is achieved in a small shape.

APPLICATION

AV equipment, digital consumer electronics

PART NUMBER CONSTRUCTION

PFC		3514QM		-		351		K		07		E-**	
Series name	Core shape	Inductance code		Inductance tolerance		Rated Peak current code*1		Internal code					
PFC3514QM		350	35μH (35x10 ⁰)	K	±10%	01	1A						
PFC3318QM		351	350μH (35x10 ¹)			07	7A						
PFC3519QM		352	3500μH(35x10 ²)			10	10A						
PFC3819QM													
PFC4124QM													
PFC2723ER													
PFC3125ER													
PFC3525ER													
PFC3820QN													
PFC3831QN													

*1 The rounded-off value.

OPERATING TEMPERATURE RANGE, PACKAGE QUANTITY, PRODUCT WEIGHT

Type	Temperature range		Package quantity (pieces/box)	Individual weight*4 (g)
	Operating temperature*2 (°C)	Storage temperature*3 (°C)		
	PFC3514QM	-30 to +120		
PFC3318QM	-30 to +120	-40 to +80	140	27.6
PFC3519QM	-30 to +120	-40 to +80	140	50.3
PFC3819QM	-30 to +120	-40 to +80	100	60.5
PFC4124QM	-30 to +120	-40 to +80	90	91.9
PFC2723ER	-30 to +120	-40 to +80	150	34.1
PFC3125ER	-30 to +120	-40 to +80	120	49.7
PFC3525ER	-30 to +120	-40 to +80	120	57.3
PFC3820QN	-30 to +120	-40 to +80	105	71.9
PFC3831QN	-30 to +120	-40 to +80	63	115.3

*2 Operating temperature range includes self-temperature rise.

*3 The Storage temperature range is for after the circuit board is mounted.

*4 Typical weight.

○ RoHS Directive Compliant Product: See the following for more details.<https://product.tdk.com/info/en/environment/rohs/index.html>

 Please be sure to request delivery specifications that provide further details on the features and specifications of the products for proper and safe use.
Please note that the contents may change without any prior notice due to reasons such as upgrading.

PFC QM series

PFC3514QM Type

SHAPE & DIMENSIONS

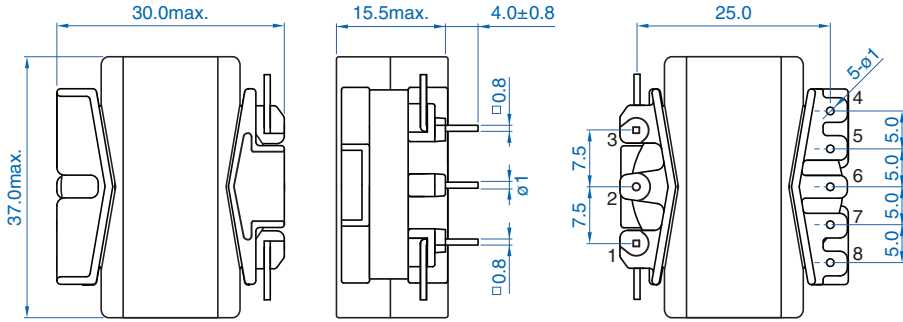

Dimensions in mm

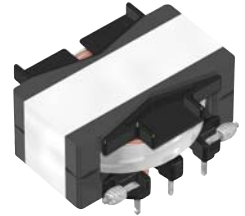

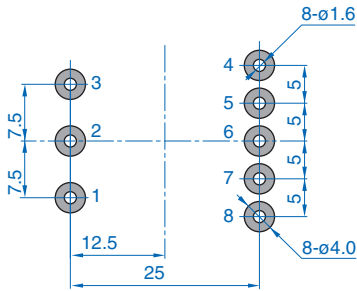

RECOMMENDED LAND PATTERN

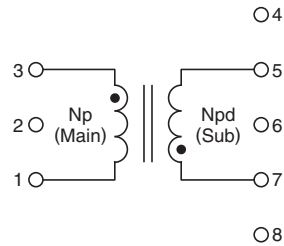

Dimensions in mm

CIRCUIT DIAGRAM



 Please be sure to request delivery specifications that provide further details on the features and specifications of the products for proper and safe use. Please note that the contents may change without any prior notice due to reasons such as upgrading.

PFC QM series PFC3514QM Type

ELECTRICAL CHARACTERISTICS

CHARACTERISTICS SPECIFICATION TABLE

Part number	Mount method	Frequency (kHz) min.	PFC output power (W)	Inductance (μH)	Rated peak current* ¹ (A)	Turn ratio (Np/Npd)
PFC3514QM-351K04B-00	Through hole	65	100	350	3.7	10.0
PFC3514QM-281K05B-00	Through hole	65	125	280	4.6	9.8
PFC3514QM-231K06B-00	Through hole	65	150	230	5.5	9.6

Measurement equipment*²

Measurement item	Product No.	Manufacturer
Inductance	4284A	Keysight Technologies
DC bias characteristics	4284A + 42841A	Keysight Technologies

*¹ The rated peak current is the peak value of the triangular wave current flowing through the PFC coil.

*² Equivalent measurement equipment may be used.

INDUCTANCE CHANGE VS. DC BIAS CHARACTERISTICS GRAPH (100°C)

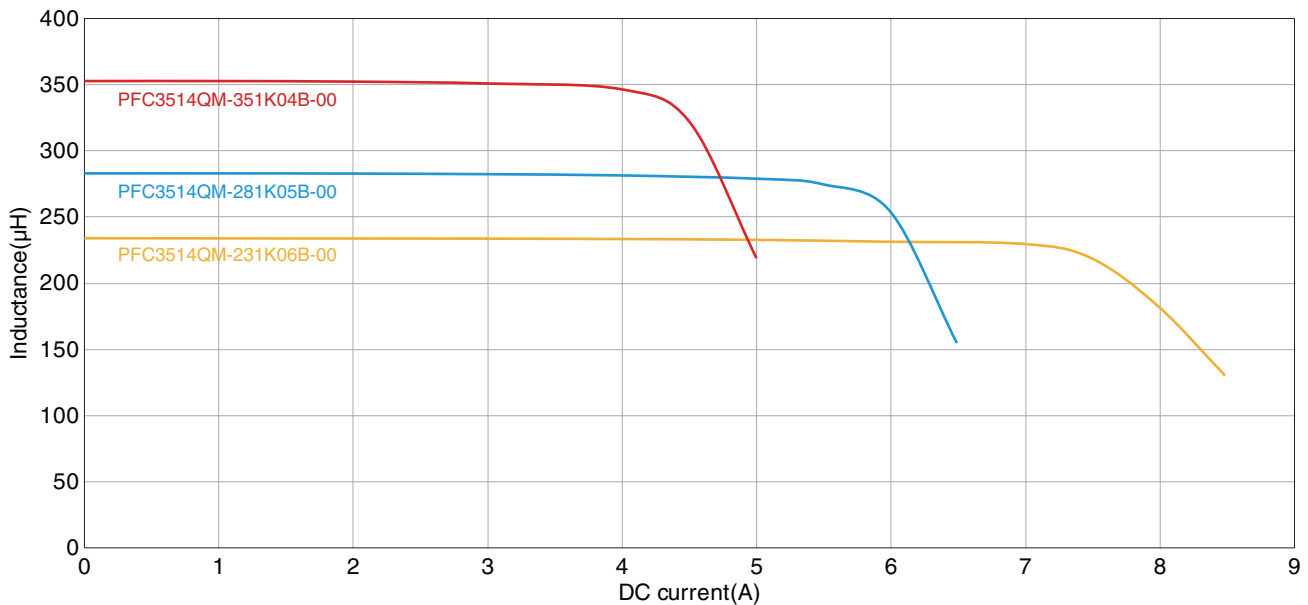

⚠ Please be sure to request delivery specifications that provide further details on the features and specifications of the products for proper and safe use.
Please note that the contents may change without any prior notice due to reasons such as upgrading.

PFC QM series

PFC3318QM Type

SHAPE & DIMENSIONS

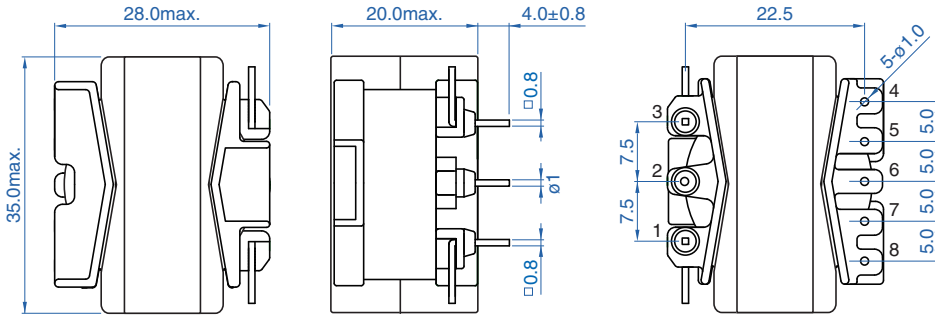

Dimensions in mm

RECOMMENDED LAND PATTERN

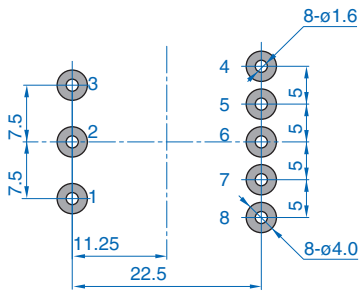

Dimensions in mm

CIRCUIT DIAGRAM

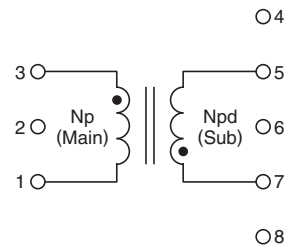

 Please be sure to request delivery specifications that provide further details on the features and specifications of the products for proper and safe use. Please note that the contents may change without any prior notice due to reasons such as upgrading.

PFC QM series PFC3318QM Type

ELECTRICAL CHARACTERISTICS

CHARACTERISTICS SPECIFICATION TABLE

Part number	Mount method	Frequency (kHz) min.	PFC output power (W)	Inductance (μH)	Rated peak current* ¹ (A)	Turn ratio (Np/Npd)
PFC3318QM-601K03B-00	Through hole	50	75	600	2.8	9.0
PFC3318QM-601K03E-00	Through hole	50	75	600	2.8	9.6
PFC3318QM-451K04B-00	Through hole	50	100	450	3.7	9.0

Measurement equipment*²

Measurement item	Product No.	Manufacturer
Inductance	4284A	Keysight Technologies
DC bias characteristics	4284A + 42841A	Keysight Technologies

*¹ The rated peak current is the peak value of the triangular wave current flowing through the PFC coil.

*² Equivalent measurement equipment may be used.

INDUCTANCE CHANGE VS. DC BIAS CHARACTERISTICS GRAPH (100°C)

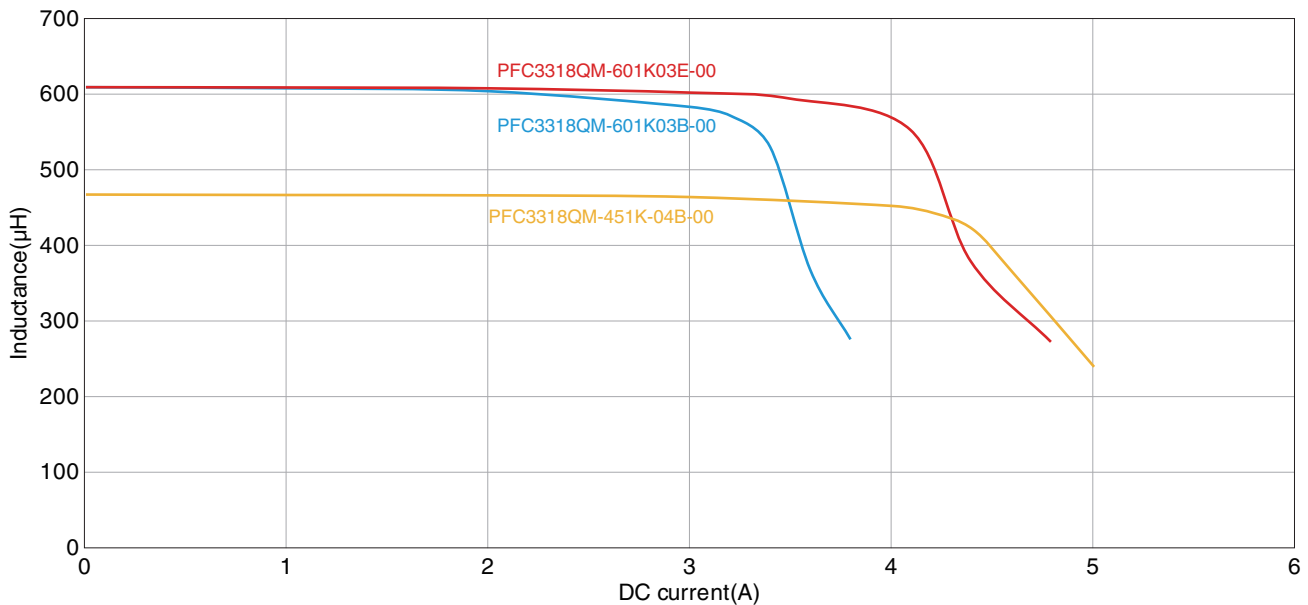

 Please be sure to request delivery specifications that provide further details on the features and specifications of the products for proper and safe use. Please note that the contents may change without any prior notice due to reasons such as upgrading.

PFC QM series

PFC3519QM Type

SHAPE & DIMENSIONS

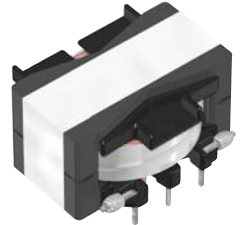
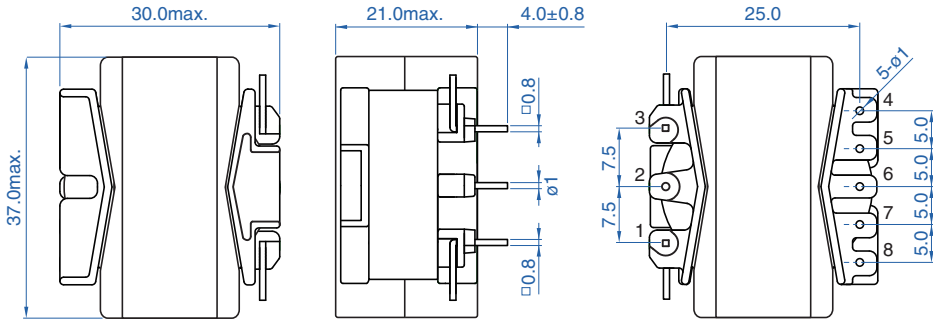

Dimensions in mm

RECOMMENDED LAND PATTERN

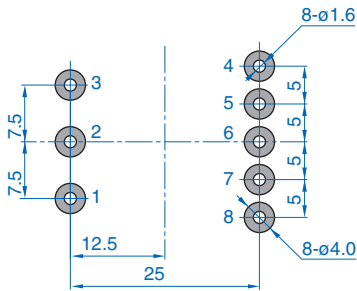

Dimensions in mm

CIRCUIT DIAGRAM

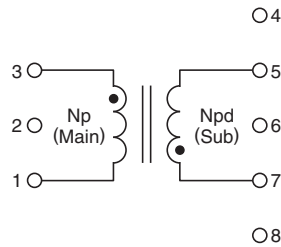

 Please be sure to request delivery specifications that provide further details on the features and specifications of the products for proper and safe use. Please note that the contents may change without any prior notice due to reasons such as upgrading.

PFC QM series PFC3519QM Type

ELECTRICAL CHARACTERISTICS

CHARACTERISTICS SPECIFICATION TABLE

Part number	Mount method	Frequency (kHz) min.	PFC output power (W)	Inductance (μH)	Rated peak current* ¹ (A)	Turn ratio (Np/Npd)
PFC3519QM-451K04E-00	Through hole	50	100	450	3.7	10
PFC3519QM-301K06B-50	Through hole	50	150	300	5.5	9.8
PFC3519QM-231K07B-50	Through hole	50	200	230	7.4	9.6

Measurement equipment*²

Measurement item	Product No.	Manufacturer
Inductance	4284A	Keysight Technologies
DC bias characteristics	4284A + 42841A	Keysight Technologies

*¹ The rated peak current is the peak value of the triangular wave current flowing through the PFC coil.

*² Equivalent measurement equipment may be used.

INDUCTANCE CHANGE VS. DC BIAS CHARACTERISTICS GRAPH (100°C)

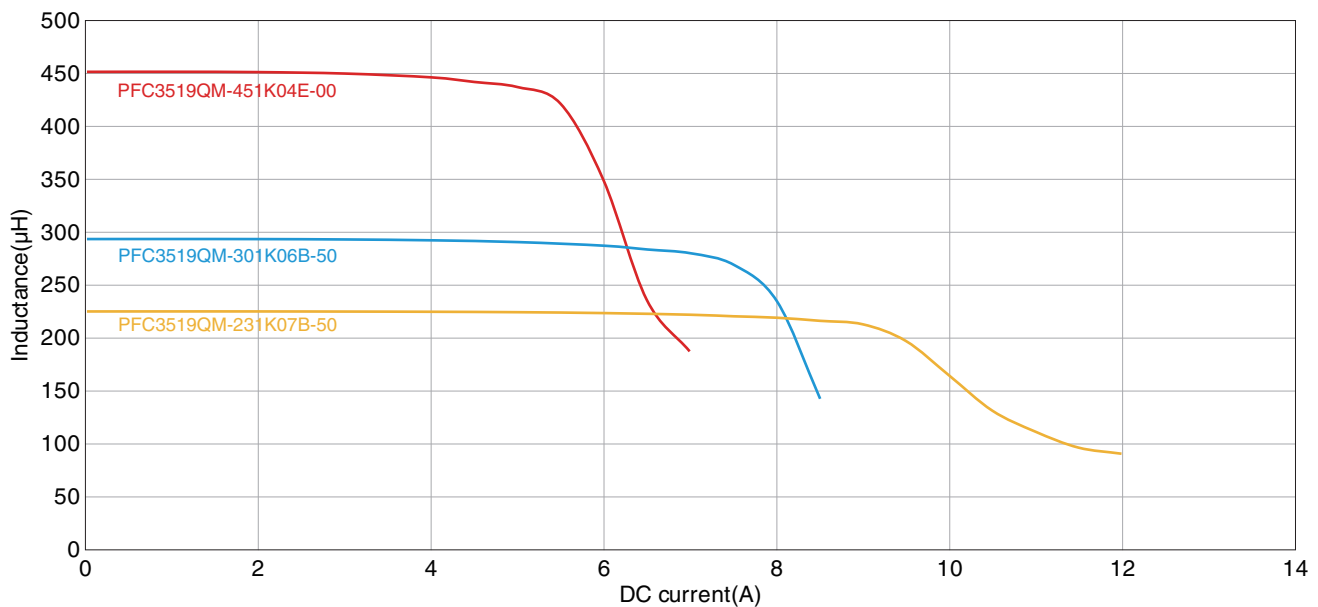

⚠ Please be sure to request delivery specifications that provide further details on the features and specifications of the products for proper and safe use. Please note that the contents may change without any prior notice due to reasons such as upgrading.

PFC QM series

PFC3819QM Type

SHAPE & DIMENSIONS

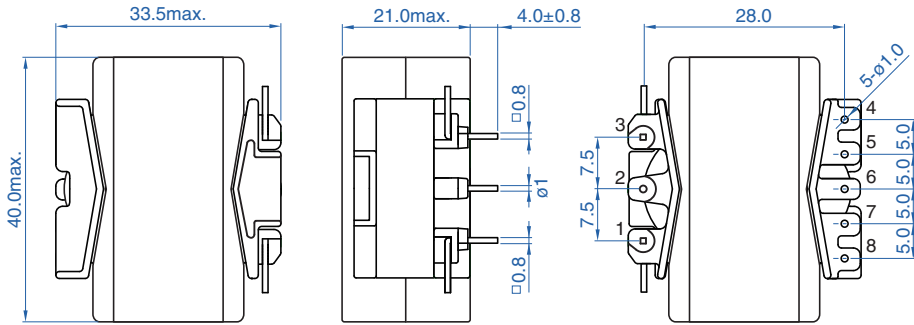

Dimensions in mm

RECOMMENDED LAND PATTERN

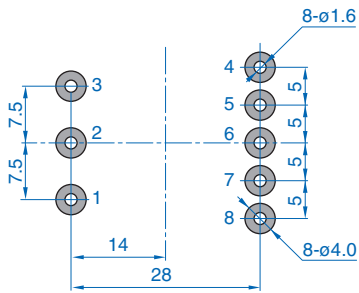

Dimensions in mm

CIRCUIT DIAGRAM

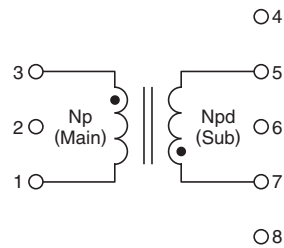

 Please be sure to request delivery specifications that provide further details on the features and specifications of the products for proper and safe use. Please note that the contents may change without any prior notice due to reasons such as upgrading.

PFC QM series PFC3819QM Type

ELECTRICAL CHARACTERISTICS

CHARACTERISTICS SPECIFICATION TABLE

Part number	Mount method	Frequency (kHz) min.	PFC output power (W)	Inductance (μH)	Rated peak current* ¹ (A)	Turn ratio (Np/Npd)
PFC3819QM-301K06E-50	Through hole	50	150	300	5.5	9.8
PFC3819QM-231K07D-50	Through hole	50	200	230	7.4	9.6
PFC3819QM-181K09B-50	Through hole	50	250	180	8.8	9.5
PFC3819QM-151K11B-00	Through hole	50	300	150	11.1	9.8

Measurement equipment*²

Measurement item	Product No.	Manufacturer
Inductance	4284A	Keysight Technologies
DC bias characteristics	4284A + 42841A	Keysight Technologies

*¹ The rated peak current is the peak value of the triangular wave current flowing through the PFC coil.

*² Equivalent measurement equipment may be used.

INDUCTANCE CHANGE VS. DC BIAS CHARACTERISTICS GRAPH (100°C)

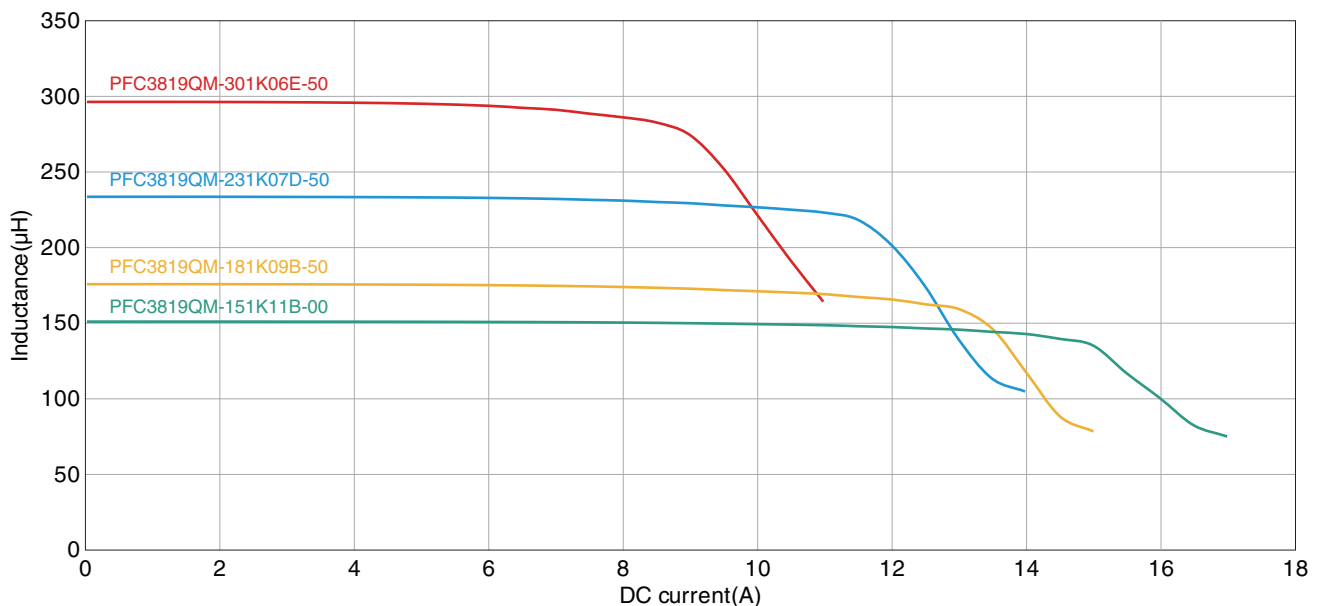

⚠ Please be sure to request delivery specifications that provide further details on the features and specifications of the products for proper and safe use. Please note that the contents may change without any prior notice due to reasons such as upgrading.

PFC QM series

PFC4124QM Type

SHAPE & DIMENSIONS

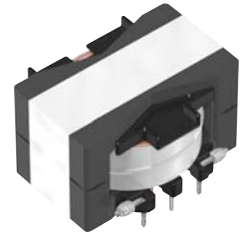
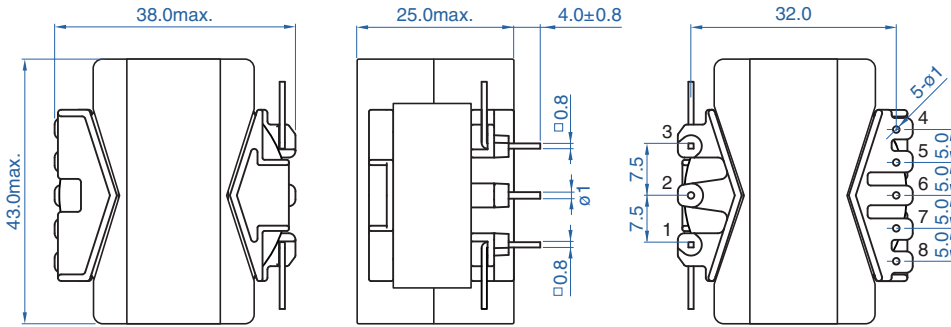

Dimensions in mm

RECOMMENDED LAND PATTERN

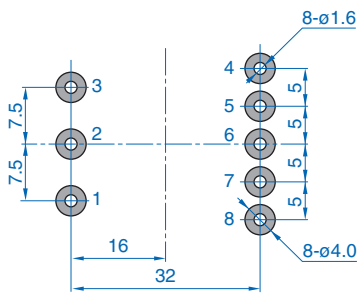

Dimensions in mm

CIRCUIT DIAGRAM

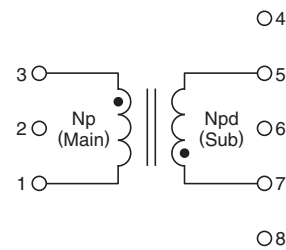

 Please be sure to request delivery specifications that provide further details on the features and specifications of the products for proper and safe use. Please note that the contents may change without any prior notice due to reasons such as upgrading.

PFC QM series PFC4124QM Type

ELECTRICAL CHARACTERISTICS

CHARACTERISTICS SPECIFICATION TABLE

Part number	Mount method	Frequency (kHz) min.	PFC output power (W)	Inductance (μH)	Rated peak current* ¹ (A)	Turn ratio (Np/Npd)
PFC4124QM-181K09D-00	Through hole	50	250	180	8.8	9.5
PFC4124QM-151K11D-00	Through hole	50	300	150	11.1	9.8

Measurement equipment*²

Measurement item	Product No.	Manufacturer
Inductance	4284A	Keysight Technologies
DC bias characteristics	4284A + 42841A	Keysight Technologies

*¹ The rated peak current is the peak value of the triangular wave current flowing through the PFC coil.

*² Equivalent measurement equipment may be used.

INDUCTANCE CHANGE VS. DC BIAS CHARACTERISTICS GRAPH (100°C)

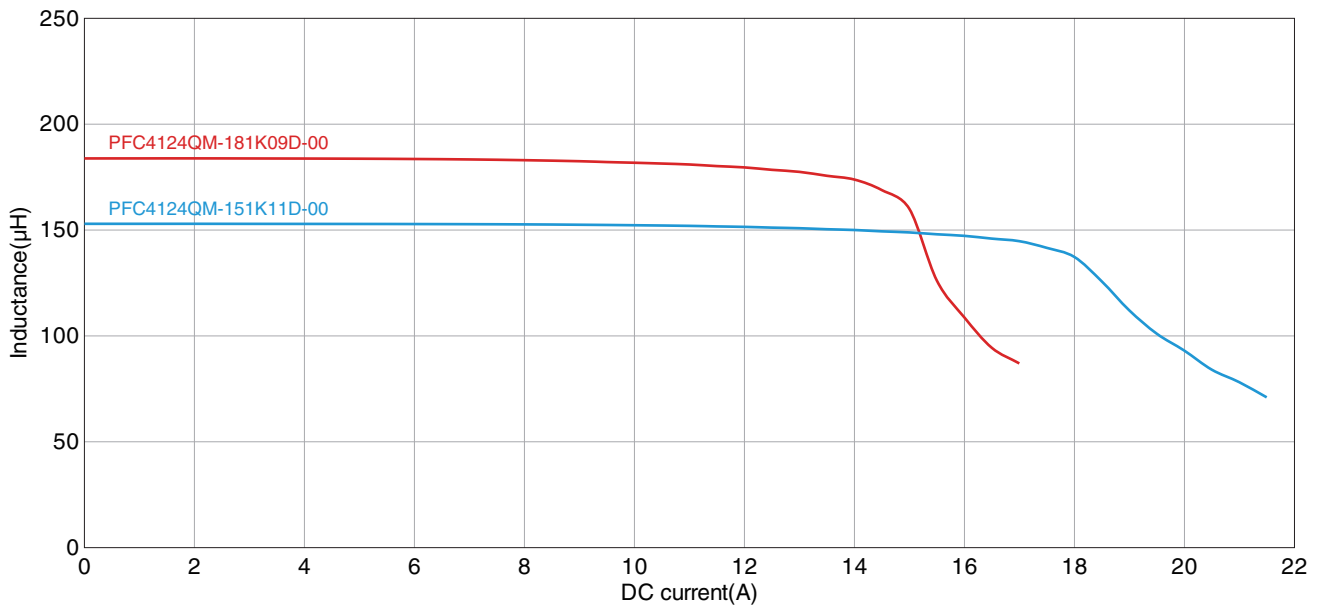

⚠ Please be sure to request delivery specifications that provide further details on the features and specifications of the products for proper and safe use. Please note that the contents may change without any prior notice due to reasons such as upgrading.

PFC ER series

PFC2723ER Type

SHAPE & DIMENSIONS

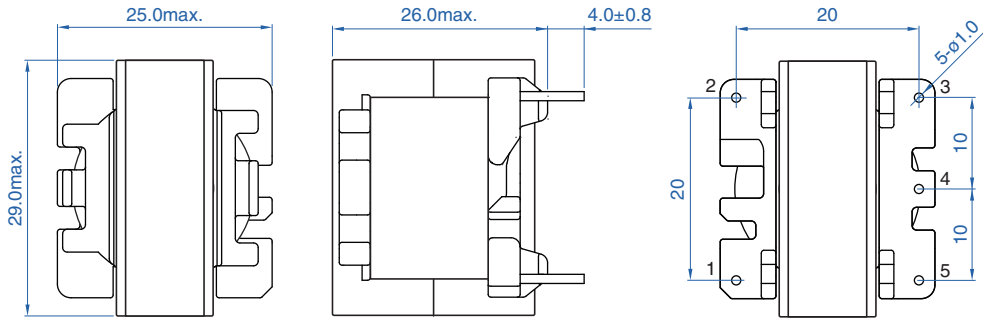

Dimensions in mm

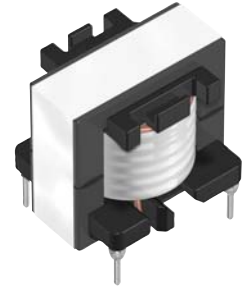

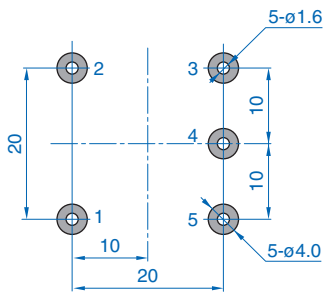

RECOMMENDED LAND PATTERN

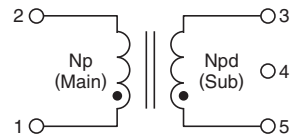

Dimensions in mm

CIRCUIT DIAGRAM



 Please be sure to request delivery specifications that provide further details on the features and specifications of the products for proper and safe use. Please note that the contents may change without any prior notice due to reasons such as upgrading.

PFC ER series **PFC2723ER Type**

■ ELECTRICAL CHARACTERISTICS

□ CHARACTERISTICS SPECIFICATION TABLE

Part number	Mount method	Frequency (kHz) min.	PFC output power (W)	Inductance (μH)	Rated peak current* ¹ (A)	Turn ratio (Np/Npd)
PFC2723ER-601K02B-00	Through hole	50	75	600	2.4	9.8
PFC2723ER-421K03B-50	Through hole	50	100	420	3.4	10.8

○ Measurement equipment*²

Measurement item	Product No.	Manufacturer
Inductance	4284A	Keysight Technologies
DC bias characteristics	4284A + 42841A	Keysight Technologies

*¹ The rated peak current is the peak value of the triangular wave current flowing through the PFC coil.

*² Equivalent measurement equipment may be used.

□ INDUCTANCE CHANGE VS. DC BIAS CHARACTERISTICS GRAPH (100°C)

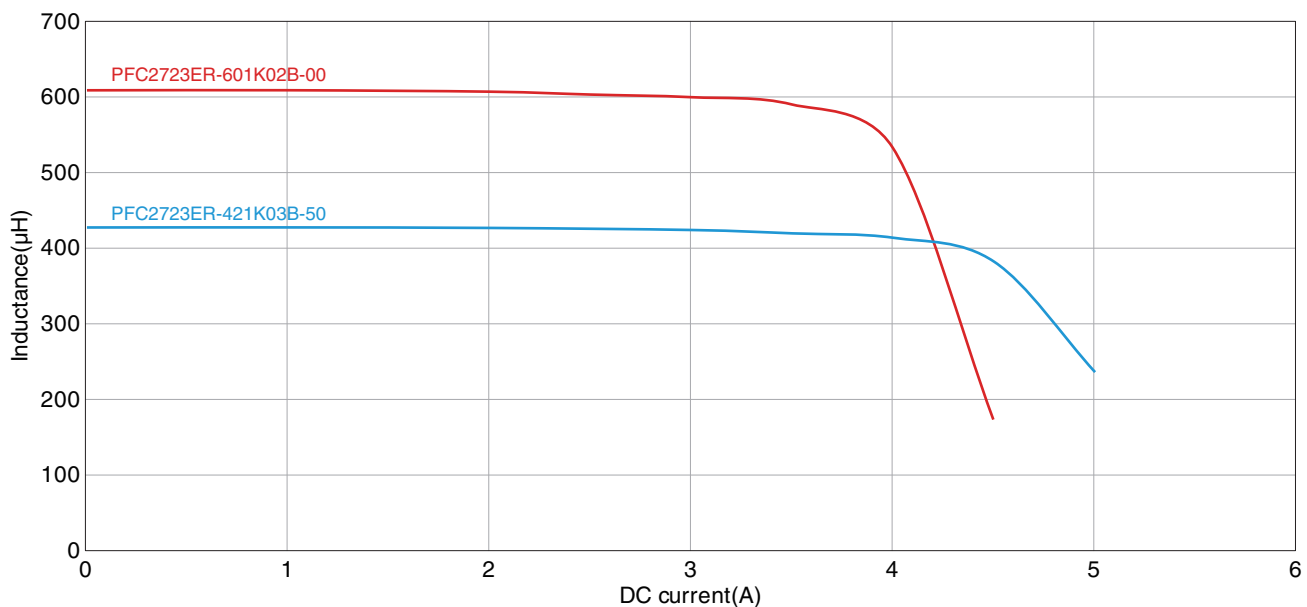

⚠ Please be sure to request delivery specifications that provide further details on the features and specifications of the products for proper and safe use.
Please note that the contents may change without any prior notice due to reasons such as upgrading.

PFC ER series

PFC3125ER Type

SHAPE & DIMENSIONS

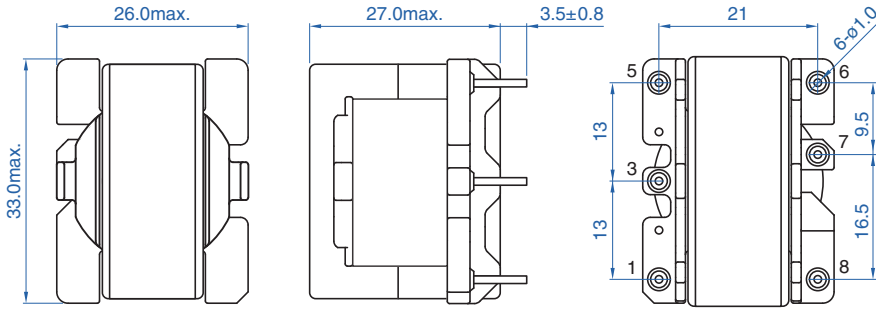

Dimensions in mm



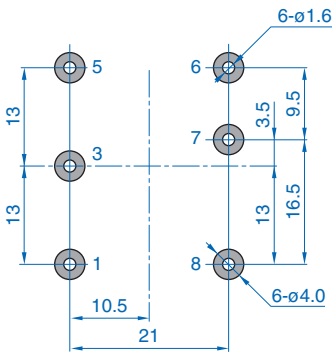

RECOMMENDED LAND PATTERN

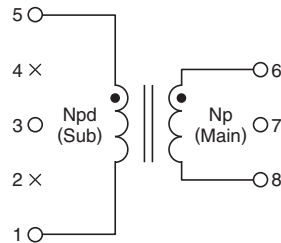

Dimensions in mm

CIRCUIT DIAGRAM



 Please be sure to request delivery specifications that provide further details on the features and specifications of the products for proper and safe use. Please note that the contents may change without any prior notice due to reasons such as upgrading.

PFC ER series PFC3125ER Type

ELECTRICAL CHARACTERISTICS

CHARACTERISTICS SPECIFICATION TABLE

Part number	Mount method	Frequency (kHz) min.	PFC output power (W)	Inductance (μH)	Rated peak current*1 (A)	Turn ratio (Np/Npd)
PFC3125ER-451K03E-00	Through hole	50	100	450	2.7	10.0
PFC3125ER-301K05B-00	Through hole	50	150	300	4.9	10.4
PFC3125ER-231K06B-00	Through hole	50	200	230	6.4	9.0

Measurement equipment*2

Measurement item	Product No.	Manufacturer
Inductance	4284A	Keysight Technologies
DC bias characteristics	4284A + 42841A	Keysight Technologies

*1 The rated peak current is the peak value of the triangular wave current flowing through the PFC coil.

*2 Equivalent measurement equipment may be used.

INDUCTANCE CHANGE VS. DC BIAS CHARACTERISTICS GRAPH (100°C)

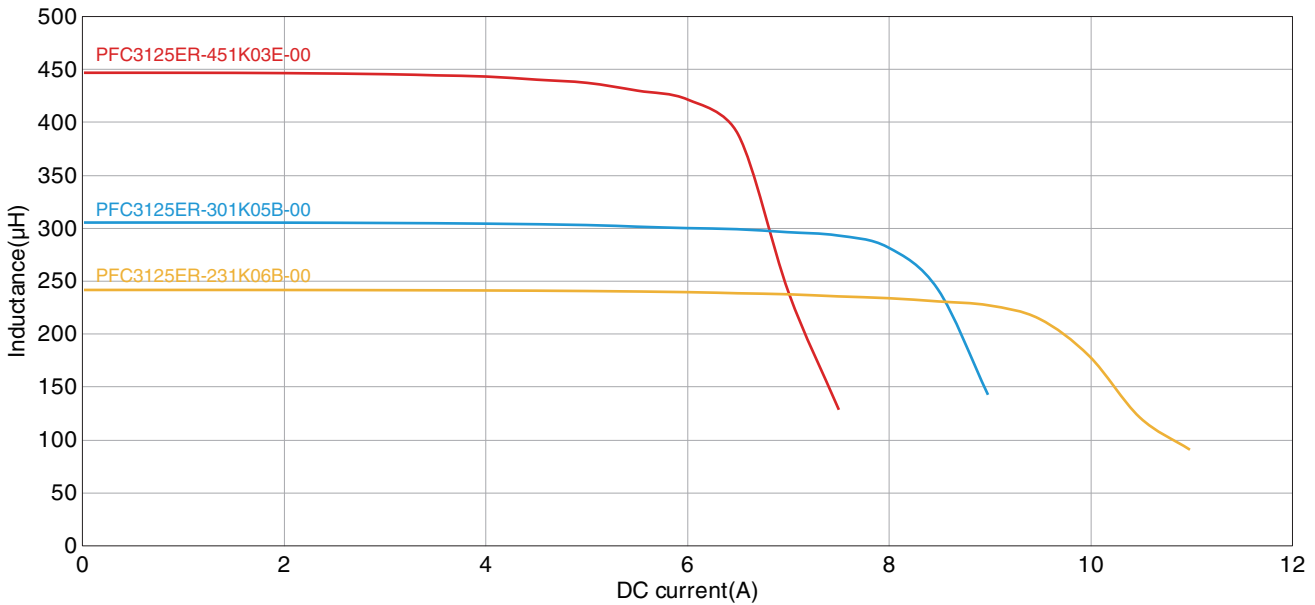

 Please be sure to request delivery specifications that provide further details on the features and specifications of the products for proper and safe use. Please note that the contents may change without any prior notice due to reasons such as upgrading.

PFC ER series PFC3525ER Type

ELECTRICAL CHARACTERISTICS

CHARACTERISTICS SPECIFICATION TABLE

Part number	Mount method	Frequency (kHz) min.	PFC output power (W)	Inductance (μH)	Rated peak current* ¹ (A)	Turn ratio (Np/Npd)
PFC3525ER-301K04E-00	Through hole	50	150	300	4.1	10.4
PFC3525ER-231K06E-00	Through hole	50	200	225	5.6	10.0
PFC3525ER-181K09B-00	Through hole	50	250	180	9.5	10.5

Measurement equipment*²

Measurement item	Product No.	Manufacturer
Inductance	4284A	Keysight Technologies
DC bias characteristics	4284A + 42841A	Keysight Technologies

*¹ The rated peak current is the peak value of the triangular wave current flowing through the PFC coil.

*² Equivalent measurement equipment may be used.

INDUCTANCE CHANGE VS. DC BIAS CHARACTERISTICS GRAPH (100°C)

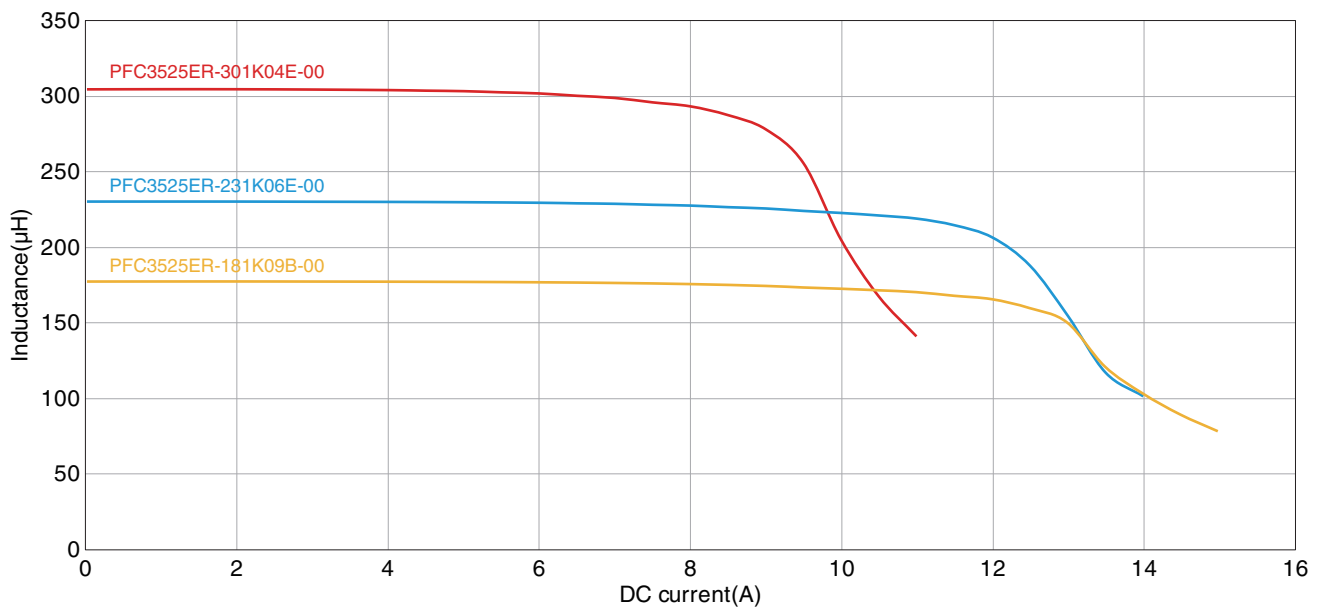

⚠ Please be sure to request delivery specifications that provide further details on the features and specifications of the products for proper and safe use.
Please note that the contents may change without any prior notice due to reasons such as upgrading.

PFC QN series

PFC3820QN Type

SHAPE & DIMENSIONS

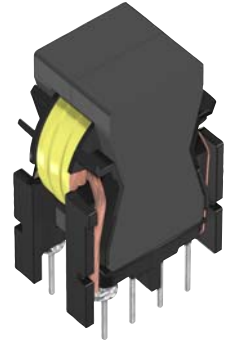
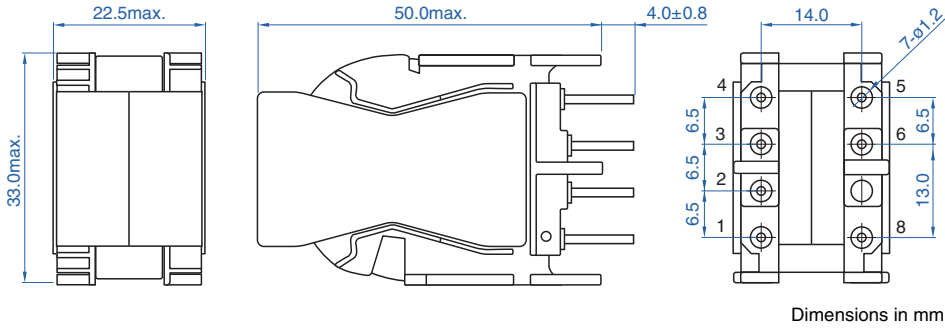

RECOMMENDED LAND PATTERN

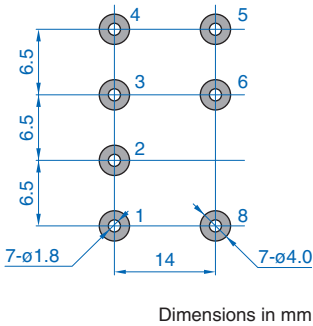

CIRCUIT DIAGRAM

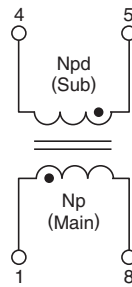

 Please be sure to request delivery specifications that provide further details on the features and specifications of the products for proper and safe use. Please note that the contents may change without any prior notice due to reasons such as upgrading.

PFC QN series PFC3820QN Type

ELECTRICAL CHARACTERISTICS

CHARACTERISTICS SPECIFICATION TABLE

Part number	Mount method	Frequency (kHz) min.	PFC output power* ¹ (W)	Inductance (μH)	Rated peak current* ² (A)	Turn ratio (Np/Npd)
PFC3820QN-900K11B-00	Through hole	35	800	90	11	7

○ Measurement equipment*³

Measurement item	Product No.	Manufacturer
Inductance	4284A	Keysight Technologies
DC bias characteristics	4284A + 42841A	Keysight Technologies

*¹ Output power at 220 Vac input.

*² The rated peak current is the peak value of the triangular wave current flowing through the PFC coil.

*³ Equivalent measurement equipment may be used.

INDUCTANCE CHANGE VS. DC BIAS CHARACTERISTICS GRAPH (100°C)

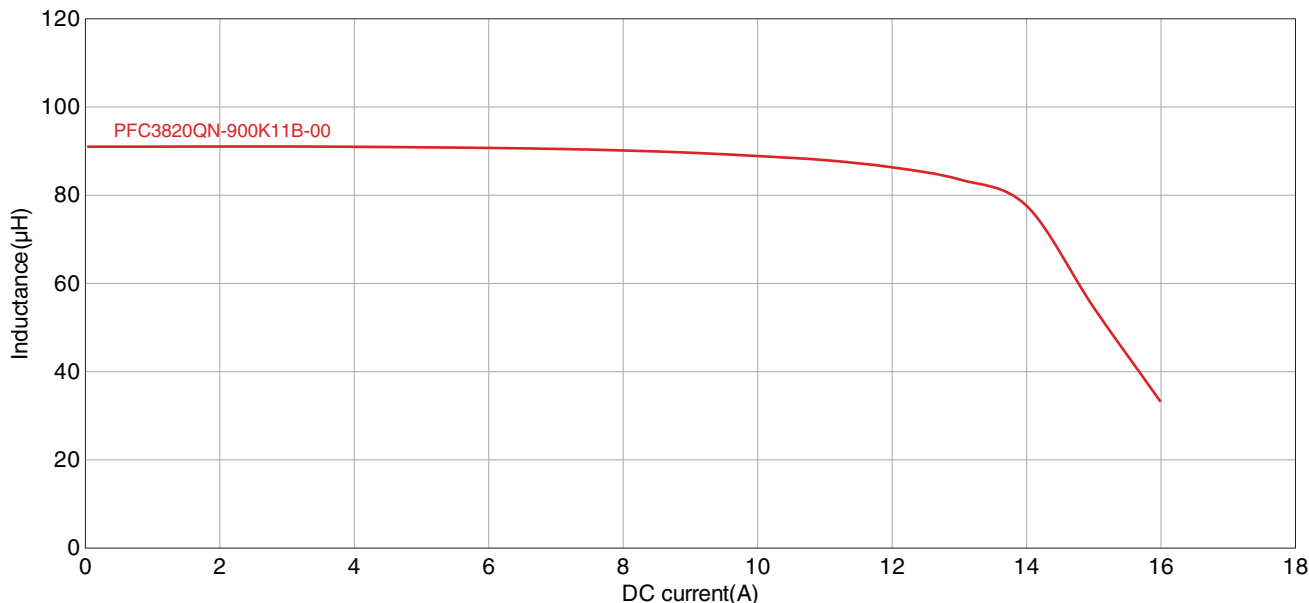

 Please be sure to request delivery specifications that provide further details on the features and specifications of the products for proper and safe use. Please note that the contents may change without any prior notice due to reasons such as upgrading.

PFC QN series

PFC3831QN Type

SHAPE & DIMENSIONS

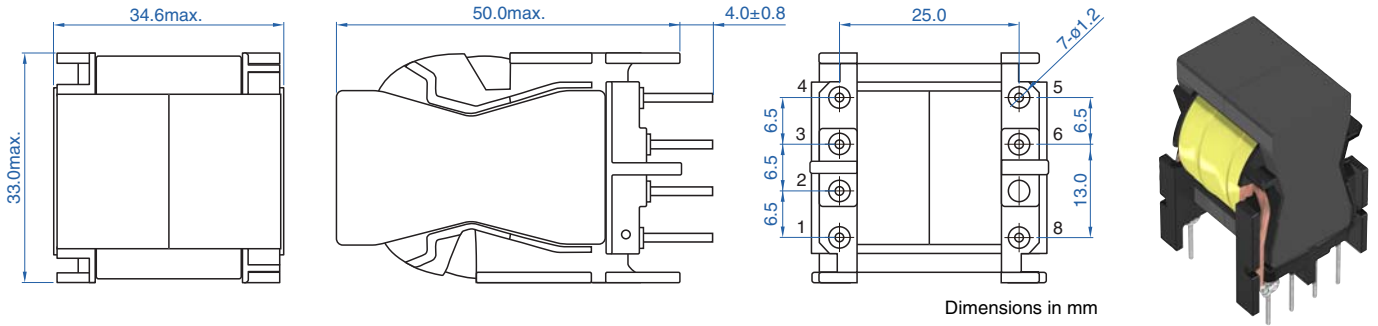

RECOMMENDED LAND PATTERN

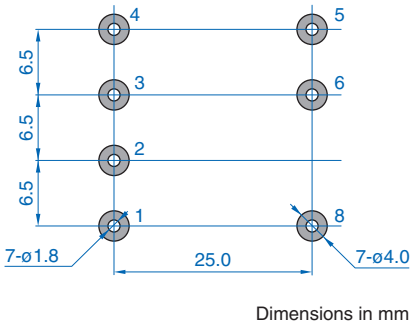

CIRCUIT DIAGRAM

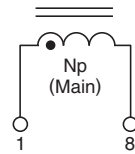

 Please be sure to request delivery specifications that provide further details on the features and specifications of the products for proper and safe use. Please note that the contents may change without any prior notice due to reasons such as upgrading.

PFC QN series **PFC3831QN Type**

■ ELECTRICAL CHARACTERISTICS

□ CHARACTERISTICS SPECIFICATION TABLE

Part number	Mount method	Frequency (kHz) min.	PFC output power* ¹ (W)	Inductance (μH)	Rated peak current* ² (A)	Turn ratio (Np/Npd)
PFC3831QN-351K08B-00	Through hole	50	900	350	8	—

○ Measurement equipment*³

Measurement item	Product No.	Manufacturer
Inductance	4284A	Keysight Technologies
DC bias characteristics	4284A + 42841A	Keysight Technologies

*¹ Output power at 220 Vac input.*² The rated peak current is the peak value of the triangular wave current flowing through the PFC coil.*³ Equivalent measurement equipment may be used.

□ INDUCTANCE CHANGE VS. DC BIAS CHARACTERISTICS GRAPH (100°C)

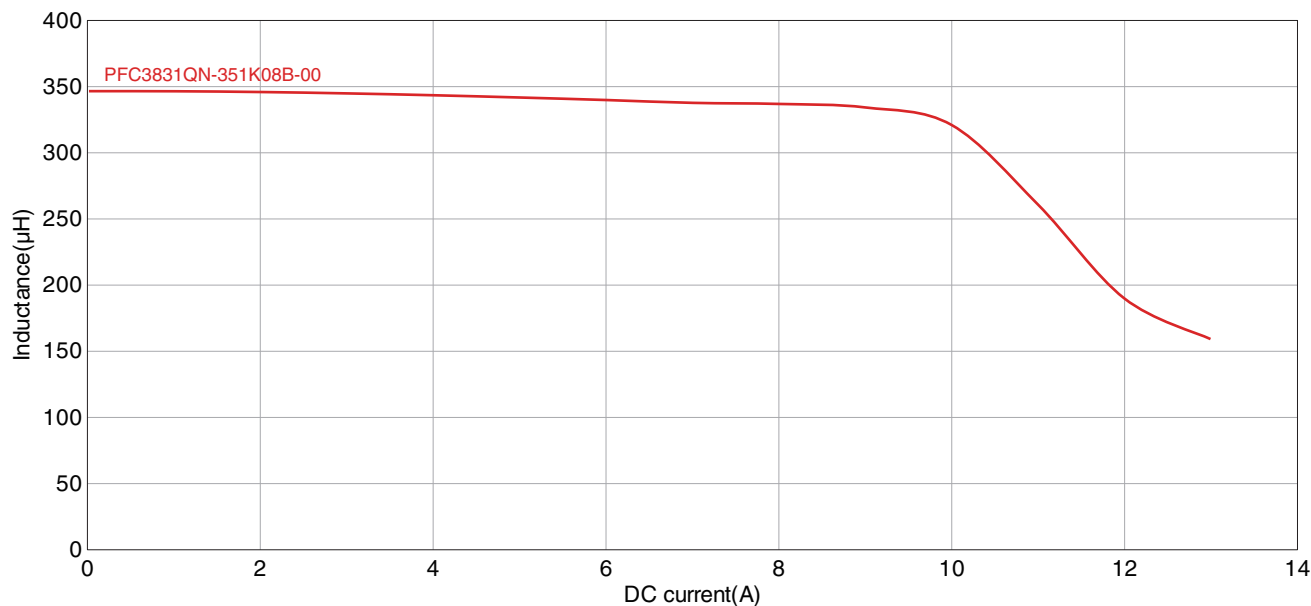

TRANSFORMERS

PFC Circuit Inductance Specification Request Form

Issued on _____ / _____ / _____

1. Company name _____
Address _____

2. Department, applicant's name

Name: _____
TEL/FAX : _____
E-mail : _____

Person in Charge from Sales Promotion Dep.: _____	Recorded Date / / _____
Person in Charge from Sales Dep.: _____	Recorded Date / / _____
Prototype No: _____	Recorded Date / / _____

3. Circuit system (Fill in the (□) square like this (■) to make your selection.)

Continuous mode Critical mode Interleave Other (_____)

4. Input specifications

AC input voltage: Rated _____ (V) to _____ (V) Operating range: _____ (V) to _____ (V)
Frequency _____ (Hz) Minimum operating input voltage: _____ (V) to _____ (V)

5. Design condition

- (1) Clock frequency (Fill in the (□) square like this (■) to make your selection.) Continuous mode(fixed frequency) : _____ (kHz)
Critical mode(lowest frequency) : _____ (kHz)
- (2) Output voltage _____ (Vdc)
- (3) Rated output power/Maximum peak power _____ (W) / _____ (W)
- (4) Minimum operating input voltage _____ (Vac)
- (5) Overcurrent point condition (ex.: 130% in (3)Rated output power and (4) Minimum operating input voltage) _____ (%)
- (6) Maximum temperature rise Δ T _____ (°C)
Condition in temperature evaluation (ex.: minimum input, rated load) _____
- (7) Auxiliary winding (Fill in the (□) square like this (■) to make your selection.) Yes No
Number of windings _____ (Windings)
Desired voltage value and current _____ (V) / _____ (mA)
Necessity of insulation (Fill in the (□) square like this (■) to make your selection.) Functional insulation Reinforced insulation
- (8) Circuit diagram (If you desire any pin number, attach a circuit diagram.) Yes No

6. Inductance value and saturated current value for reference

Inductance value: _____ μ(H) Saturated current value: _____ (A)

7. Desired core size and external size

Core size: _____ External size L: _____ W: _____ H(Height from the board): _____ mm max.

8. IC expected to be used

Manufacturer name: _____ Product No.: _____

9. Production quantity information

Final set name: _____ Desired price/Currency: _____
Acceptance conditions of the above price (FCA CHN, CIP LA, DDP Paris etc.): _____
Production volume: _____ k/M Production start period: _____ Production place: _____
Prototyping time: (ES1) _____ (ES2) _____ (PP1) _____ (PP2) _____ (MP1) _____

10. Sample information

Required sample quantity _____ pcs. Requested delivery time: _____

11. Note company regulations, such as safe distance and dielectric voltage strength, if there are any.

12. If there are any other requests (priorities in the company, size or price, etc.) or alterable items, please provide a description.

TDK Corporation Magnetics Business Group, Strategic Product Marketing Division
2-5-1 Nihonbashi, Chuo-ku, Tokyo, 103-6128, Japan TEL: 81-3-6778-1034, FAX: 81-3-6778-1155

 Please be sure to request delivery specifications that provide further details on the features and specifications of the products for proper and safe use. Please note that the contents may change without any prior notice due to reasons such as upgrading.