

C2012JB2A223K125AA

TDK Item Description : C2012JB2A223KT****



Application & Main Feature

Commercial Grade (Mid Voltage (100 to 630V))

Series

C2012 [EIA CC0805]

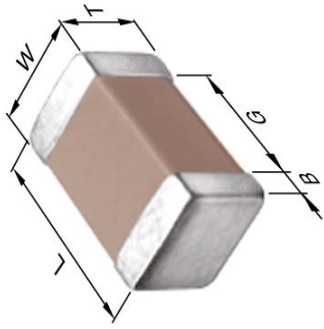

Dimensions

L	2.00mm	+/-0.2mm
W	1.25mm	+/-0.2mm
T	1.25mm	+/-0.2mm
B	0.20mm	Min.
G	0.50mm	Min.

Temperature Characteristic

JB (-25 to 85 degC +/-10%)

Rated Voltage

2A (100Vdc)

Capacitance

22nF

Capacitance Tolerance

K (+/-10%)

Dissipation Factor

3% Max.

Insulation Resistance

10Gohm Min.

AEC-Q200

Not Applicable

DC Bias Characteristic

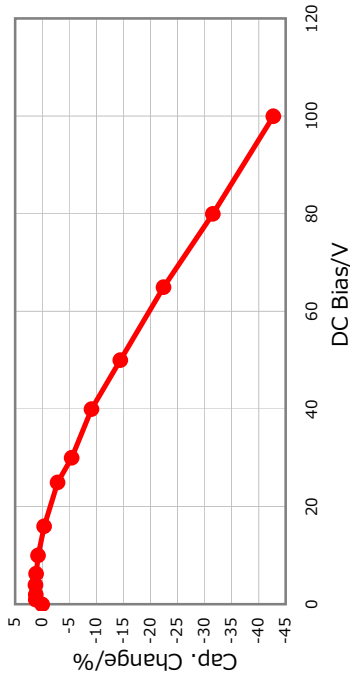

|Z|, ESR vs. Freq. Characteristics

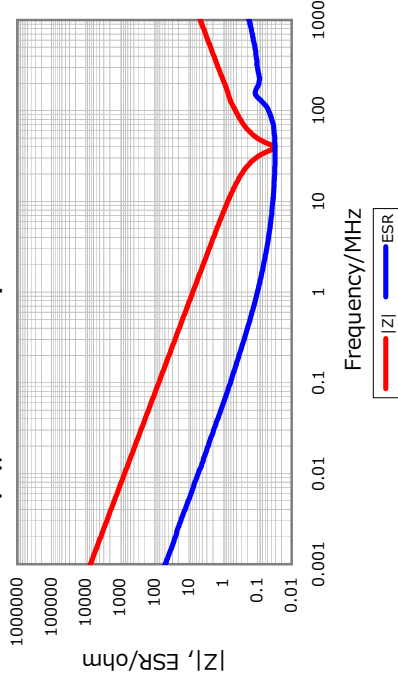

Cap. vs. Freq. Characteristic

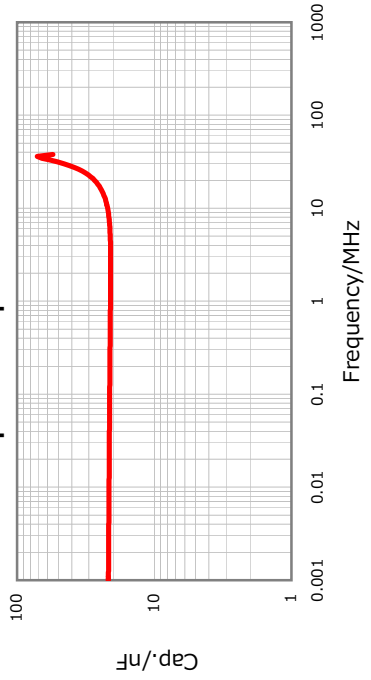

Temperature Characteristics

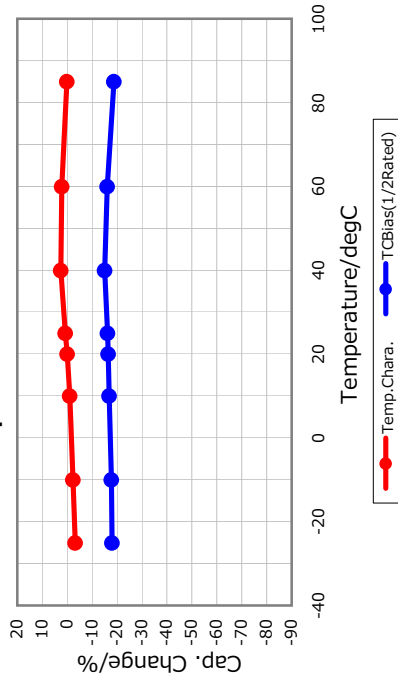

Ripple Temperature Rise Characteristics

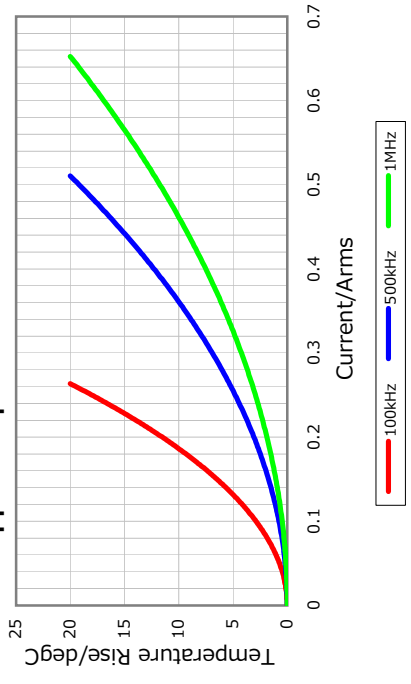

All specifications are subject to change without notice.

January 3, 2016