

CGA3E2X8R1H472M080AA

TDK Item Description : CGA3E2X8R1H472MT****

Equivalent C1608X8R1H472M for Automotive

Application & Main Feature

Automotive Grade (High Temperature Application)

Series

CGA3(1608) [EIA CC0603]

Dimensions

L	1.60mm	+/-0.1mm
W	0.80mm	+/-0.1mm
T	0.80mm	+/-0.1mm
B	0.20mm	Min.
G	0.30mm	Min.

Temperature Characteristic

X8R (-55 to 150 degC +/-15%)

Rated Voltage

1H (50Vdc)

Capacitance

4.7nF

Capacitance Tolerance

M (+/-20%)

Dissipation Factor

3% Max.

Insulation Resistance

10Gohm Min.

AEC-Q200

Yes

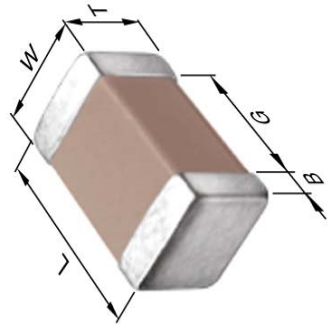

DC Bias Characteristic

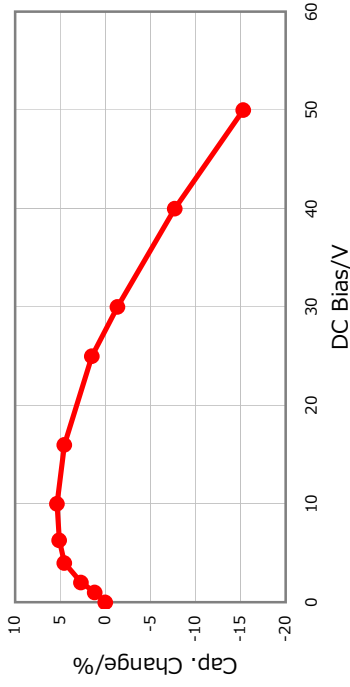

|Z|, ESR vs. Freq. Characteristics

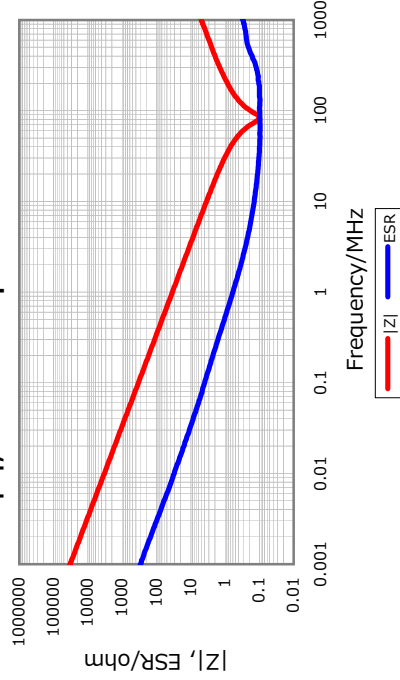

Cap. vs. Freq. Characteristic

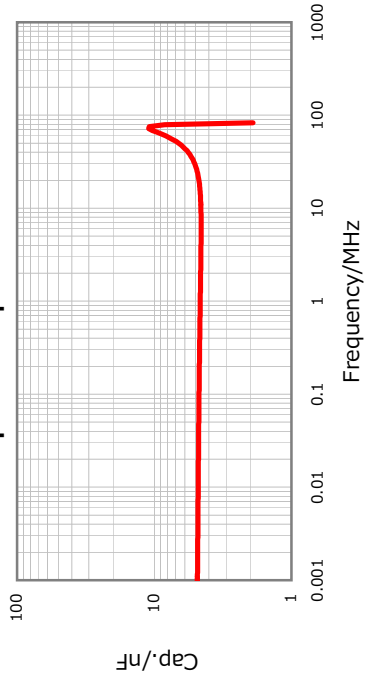

Temperature Characteristics

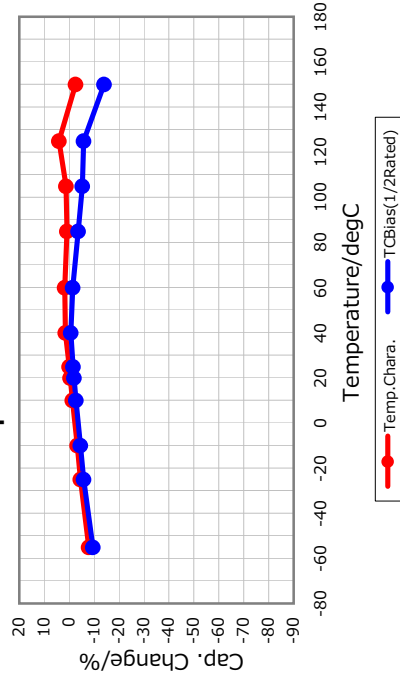

Ripple Temperature Rise Characteristics

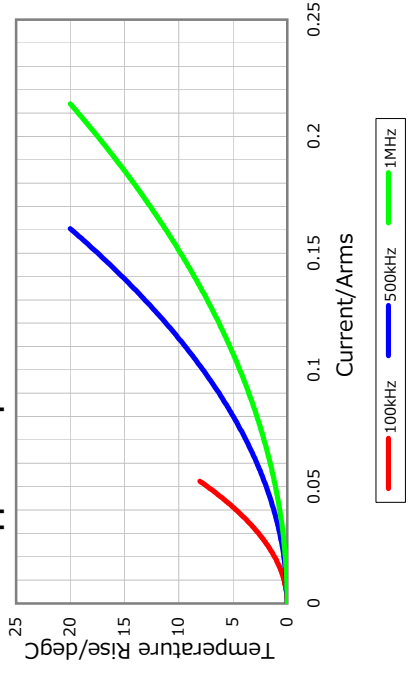

All specifications are subject to change without notice.

January 4, 2016