

RF/Microwave Capacitors

RF/Microwave Multilayer Capacitors (MLC)

CDR Series – MIL-PRF-55681 (RF/Microwave Chips)



MILITARY DESIGNATION PER MIL-PRF-55681

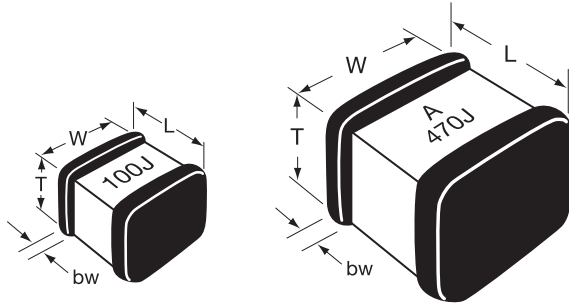

CDR11/12

CDR13/14

PACKAGING

Standard Packaging Quantity
 CDR11-12 = 100 pcs per waffle pack
 CDR13-14 = 80 pcs per waffle pack

TAPE & REEL:

All tape and reel specifications are in compliance with EIA RS481 (equivalent to IEC 286 part 3).

Sizes SQCA through SQCB, CDR11/12 through 13/14.

- 8mm carrier
- 7" reel: ≤ 0.040 " thickness = 2000 pcs
- ≤ 0.075 " thickness = 2000 pcs
- 13" reel: ≤ 0.075 " thickness = 10,000 pcs

CROSS REFERENCE: AVX/MIL-PRF-55681

Per MIL-C-55681	AVX Style	Length (L)	Width (W)	Thickness (T)		Termination Band (bw)	
				Max	Min	Max	Min
CDR11	AQ11	.055±.015 (1.40±.381)	.055±.015 (1.40±.381)	.057 (1.45)	.020 (.508)	.020 (.508)	.005 (.127)
CDR12	AQ12	.055±.025 (1.40±.635)	.055±.015 (1.40±.381)	.057 (1.45)	.020 (.508)	.020 (.508)	.005 (.127)
CDR13	AQ13	.110±.020 (2.79±.508)	.110±.020 (2.79±.508)	.102 (2.59)	.030 (.762)	.025 (.635)	.005 (.127)
CDR14	AQ14	.110 +.035 -0.020 (2.79 +.889 -.508)	.110±.020 (2.79±.508)	.102 (2.59)	.030 (.762)	.025 (.635)	.005 (.127)

HOW TO ORDER

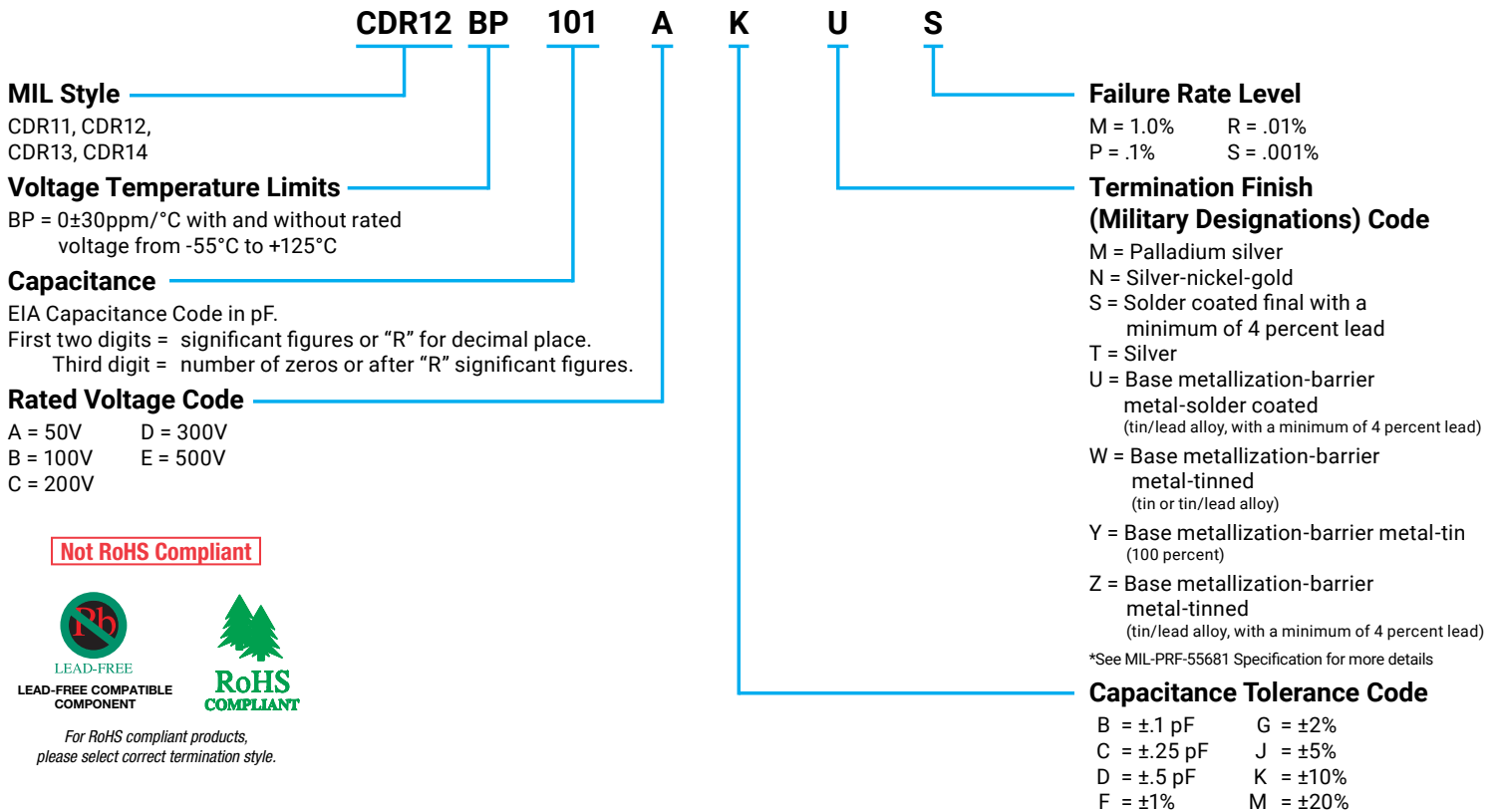

RF/Microwave Capacitors

RF/Microwave Multilayer Capacitors (MLC)

CDR Series – MIL-PRF-55681 (RF/Microwave Chips)



TABLE I: STYLES CDR11 AND CDR12 CAPACITOR CHARACTERISTICS

Type Designation 1/	Capacitance in pF	Capacitance tolerance	Rated temperature and V/Temperature	WVDC
CDR1 -B-0R1AB--	0.1	B	BP	50
CDR1 -B-0R2AB--	0.2	B	BP	50
CDR1 -B-0R3A---	0.3	B, C	BP	50
CDR1 -B-0R4A---	0.4	B, C	BP	50
CDR1 -B-0R5A---	0.5	B, C, D	BP	50
CDR1 -B-0R6A---	0.6	B, C, D	BP	50
CDR1 -B-0R7A---	0.7	B, C, D	BP	50
CDR1 -B-0R8A---	0.8	B, C, D	BP	50
CDR1 -B-0R9A---	0.9	B, C, D	BP	50
CDR1 -B-1R0A---	1.0	B, C, D	BP	50
CDR1 -B-1R1A---	1.1	B, C, D	BP	50
CDR1 -B-1R2A---	1.2	B, C, D	BP	50
CDR1 -B-1R3A---	1.3	B, C, D	BP	50
CDR1 -B-1R4A---	1.4	B, C, D	BP	50
CDR1 -B-1R5A---	1.5	B, C, D	BP	50
CDR1 -B-1R6A---	1.6	B, C, D	BP	50
CDR1 -B-1R7A---	1.7	B, C, D	BP	50
CDR1 -B-1R8A---	1.8	B, C, D	BP	50
CDR1 -B-1R9A---	1.9	B, C, D	BP	50
CDR1 -B-2R0A---	2.0	B, C, D	BP	50
CDR1 -B-2R1A---	2.1	B, C, D	BP	50
CDR1 -B-2R2A---	2.2	B, C, D	BP	50
CDR1 -B-2R4A---	2.4	B, C, D	BP	50
CDR1 -B-2R7A---	2.7	B, C, D	BP	50
CDR1 -B-3R0A---	3.0	B, C, D	BP	50
CDR1 -B-3R3A---	3.3	B, C, D	BP	50
CDR1 -B-3R6A---	3.6	B, C, D	BP	50
CDR1 -B-3R9A---	3.9	B, C, D	BP	50
CDR1 -B-4R3A---	4.3	B, C, D	BP	50
CDR1 -B-4R7A---	4.7	B, C, D	BP	50
CDR1 -B-5R1A---	5.1	B, C, D	BP	50
CDR1 -B-5R6A---	5.6	B, C, D	BP	50
CDR1 -B-6R2A---	6.2	B, C, D	BP	50
CDR1 -B-6R8A---	6.8	B, C, J, K, M	BP	50
CDR1 -B-7R5A---	7.5	B, C, J, K, M	BP	50
CDR1 -B-8R2A---	8.2	B, C, J, K, M	BP	50
CDR1 -B-9R1A---	9.1	B, C, J, K, M	BP	50
CDR1 -B-10A---	10	F, G, J, K, M	BP	50
CDR1 -B-110A---	11	F, G, J, K, M	BP	50
CDR1 -B-120A---	12	F, G, J, K, M	BP	50
CDR1 -B-130A---	13	F, G, J, K, M	BP	50
CDR1 -B-150A---	15	F, G, J, K, M	BP	50
CDR1 -B-160A---	16	F, G, J, K, M	BP	50
CDR1 -B-180A---	18	F, G, J, K, M	BP	50
CDR1 -B-200A---	20	F, G, J, K, M	BP	50
CDR1 -B-220A---	22	F, G, J, K, M	BP	50
CDR1 -B-240A---	24	F, G, J, K, M	BP	50

Type Designation 1/	Capacitance in pF	Capacitance tolerance	Rated temperature and V/Temperature	WVDC
CDR1 -B-270A---	27	F, G, J, K, M	BP	50
CDR1 -B-300A---	30	F, G, J, K, M	BP	50
CDR1 -B-330A---	33	F, G, J, K, M	BP	50
CDR1 -B-360A---	36	F, G, J, K, M	BP	50
CDR1 -B-390A---	39	F, G, J, K, M	BP	50
CDR1 -B-430A---	43	F, G, J, K, M	BP	50
CDR1 -B-470A---	47	F, G, J, K, M	BP	50
CDR1 -B-510A---	51	F, G, J, K, M	BP	50
CDR1 -B-560A---	56	F, G, J, K, M	BP	50
CDR1 -B-620A---	62	F, G, J, K, M	BP	50
CDR1 -B-680A---	68	F, G, J, K, M	BP	50
CDR1 -B-750A---	75	F, G, J, K, M	BP	50
CDR1 -B-820A---	82	F, G, J, K, M	BP	50
CDR1 -B-910A---	91	F, G, J, K, M	BP	50
CDR1 -B-101A---	100	F, G, J, K, M	BP	50
CDR1 -B-111A---	110	F, G, J, K, M	BP	50
CDR1 -B-121A---	120	F, G, J, K, M	BP	50
CDR1 -B-131A---	130	F, G, J, K, M	BP	50
CDR1 -B-151A---	150	F, G, J, K, M	BP	50
CDR1 -B-161A---	160	F, G, J, K, M	BP	50
CDR1 -B-181A---	180	F, G, J, K, M	BP	50
CDR1 -B-201A---	200	F, G, J, K, M	BP	50
CDR1 -B-221A---	220	F, G, J, K, M	BP	50
CDR1 -B-241A---	240	F, G, J, K, M	BP	50
CDR1 -B-271A---	270	F, G, J, K, M	BP	50
CDR1 -B-301A---	300	F, G, J, K, M	BP	50
CDR1 -B-331A---	330	F, G, J, K, M	BP	50
CDR1 -B-361A---	360	F, G, J, K, M	BP	50
CDR1 -B-391A---	390	F, G, J, K, M	BP	50
CDR1 -B-431A---	430	F, G, J, K, M	BP	50
CDR1 -B-471A---	470	F, G, J, K, M	BP	50
CDR1 -B-511A---	510	F, G, J, K, M	BP	50
CDR1 -B-561A---	560	F, G, J, K, M	BP	50
CDR1 -B-621A---	620	F, G, J, K, M	BP	50
CDR1 -B-681A---	680	F, G, J, K, M	BP	50
CDR1 -B-751A---	750	F, G, J, K, M	BP	50
CDR1 -B-821A---	820	F, G, J, K, M	BP	50
CDR1 -B-911A---	910	F, G, J, K, M	BP	50
CDR1 -B-102A---	1000	F, G, J, K, M	BP	50

1/Complete type designation will include additional symbols to indicate style, voltage-temperature limits, capacitance tolerance (where applicable), termination finish ("M" or "N" for style CDR11, and "S", "U", "W", "Y" or "Z" for style CDR12) and failure rate level.

RF/Microwave Capacitors

RF/Microwave Multilayer Capacitors (MLC)

CDR Series – MIL-PRF-55681 (RF/Microwave Chips)



TABLE II: STYLES CDR13 AND CDR14 CAPACITOR CHARACTERISTICS

Type Designation 1/	Capacitance in pF	Capacitance tolerance	Rated temperature and V/Temperature	WVDC
CDR1-B-0R1*B--	0.1	B	BP	200/500
CDR1-B-0R2*B--	0.2	B	BP	200/500
CDR1-B-0R3*---	0.3	B, C	BP	200/500
CDR1-B-0R4*---	0.4	B, C	BP	200/500
CDR1-B-0R5*---	0.5	B, C, D	BP	200/500
CDR1-B-0R6*---	0.6	B, C, D	BP	200/500
CDR1-B-0R7*--	0.7	B, C, D	BP	200/500
CDR1-B-0R8*---	0.8	B, C, D	BP	200/500
CDR1-B-0R9*---	0.9	B, C, D	BP	200/500
CDR1-B-1R0*---	1.0	B, C, D	BP	200/500
CDR1-B-1R1*---	1.1	B, C, D	BP	200/500
CDR1-B-1R2*---	1.2	B, C, D	BP	200/500
CDR1-B-1R3*---	1.3	B, C, D	BP	200/500
CDR1-B-1R4*---	1.4	B, C, D	BP	200/500
CDR1-B-1R5*---	1.5	B, C, D	BP	200/500
CDR1-B-1R6*---	1.6	B, C, D	BP	200/500
CDR1-B-1R7*---	1.7	B, C, D	BP	200/500
CDR1-B-1R8*---	1.8	B, C, D	BP	200/500
CDR1-B-1R9*---	1.9	B, C, D	BP	200/500
CDR1-B-2R0*---	2.0	B, C, D	BP	200/500
CDR1-B-2R1*---	2.1	B, C, D	BP	200/500
CDR1-B-2R2*--	2.2	B, C, D	BP	200/500
CDR1-B-2R4*---	2.4	B, C, D	BP	200/500
CDR1-B-2R7*---	2.7	B, C, D	BP	200/500
CDR1-B-3R0*---	3.0	B, C, D	BP	200/500
CDR1-B-3R3*---	3.3	B, C, D	BP	200/500
CDR1-B-3R6*---	3.6	B, C, D	BP	200/500
CDR1-B-3R9*---	3.9	B, C, D	BP	200/500
CDR1-B-4R3*---	4.3	B, C, D	BP	200/500
CDR1-B-4R7*---	4.7	B, C, D	BP	200/500
CDR1-B-5R1*---	5.1	B, C, D	BP	200/500
CDR1-B-5R6*---	5.6	B, C, D	BP	200/500
CDR1-B-6R2*---	6.2	B, C, D	BP	200/500
CDR1-B-6R8*---	6.8	B, C, J, K, M	BP	200/500
CDR1-B-7R5*---	7.5	B, C, J, K, M	BP	200/500
CDR1-B-8R2*---	8.2	B, C, J, K, M	BP	200/500
CDR1-B-9R1*---	9.1	B, C, J, K, M	BP	200/500
CDR1-B-100*---	10	F, G, J, K, M	BP	200/500
CDR1-B-110*---	11	F, G, J, K, M	BP	200/500
CDR1-B-120*---	12	F, G, J, K, M	BP	200/500
CDR1-B-130*---	13	F, G, J, K, M	BP	200/500
CDR1-B-150*---	15	F, G, J, K, M	BP	200/500
CDR1-B-160*---	16	F, G, J, K, M	BP	200/500
CDR1-B-180*---	18	F, G, J, K, M	BP	200/500
CDR1-B-200*---	20	F, G, J, K, M	BP	200/500
CDR1-B-220*---	22	F, G, J, K, M	BP	200/500
CDR1-B-240*---	24	F, G, J, K, M	BP	200/500
CDR1-B-270*---	27	F, G, J, K, M	BP	200/500
CDR1-B-300*---	30	F, G, J, K, M	BP	200/500
CDR1-B-330*---	33	F, G, J, K, M	BP	200/500
CDR1-B-360*---	36	F, G, J, K, M	BP	200/500
CDR1-B-390*---	39	F, G, J, K, M	BP	200/500
CDR1-B-430*---	43	F, G, J, K, M	BP	200/500
CDR1-B-470*---	47	F, G, J, K, M	BP	200/500
CDR1-B-510*---	51	F, G, J, K, M	BP	200/500
CDR1-B-560*---	56	F, G, J, K, M	BP	200/500
CDR1-B-620*---	62	F, G, J, K, M	BP	200/500
CDR1-B-680*---	68	F, G, J, K, M	BP	200/500
CDR1-B-750*---	75	F, G, J, K, M	BP	200/500
CDR1-B-820*---	82	F, G, J, K, M	BP	200/500
CDR1-B-910*---	91	F, G, J, K, M	BP	200/500

Type Designation 1/	Capacitance in pF	Capacitance tolerance	Rated temperature and V/Temperature	WVDC
CDR1-B-101*---	100	F, G, J, K, M	BP	200/500
CDR1-B-111‡---	110	F, G, J, K, M	BP	200/300
CDR1-B-121‡---	120	F, G, J, K, M	BP	200/300
CDR1-B-131‡---	130	F, G, J, K, M	BP	200/300
CDR1-B-151‡---	150	F, G, J, K, M	BP	200/300
CDR1-B-161‡---	160	F, G, J, K, M	BP	200/300
CDR1-B-181‡---	180	F, G, J, K, M	BP	200/300
CDR1-B-201‡---	200	F, G, J, K, M	BP	200/300
CDR1-B-221C---	220	F, G, J, K, M	BP	200
CDR1-B-241C---	240	F, G, J, K, M	BP	200
CDR1-B-271C---	270	F, G, J, K, M	BP	200
CDR1-B-301C---	300	F, G, J, K, M	BP	200
CDR1-B-331C---	330	F, G, J, K, M	BP	200
CDR1-B-361C---	360	F, G, J, K, M	BP	200
CDR1-B-391C---	390	F, G, J, K, M	BP	200
CDR1-B-431C---	430	F, G, J, K, M	BP	200
CDR1-B-471C---	470	F, G, J, K, M	BP	200
CDR1-B-511B---	510	F, G, J, K, M	BP	100
CDR1-B-561B---	560	F, G, J, K, M	BP	100
CDR1-B-621B---	620	F, G, J, K, M	BP	100
CDR1-B-681A---	680	F, G, J, K, M	BP	50
CDR1-B-751A---	750	F, G, J, K, M	BP	50
CDR1-B-821A---	820	F, G, J, K, M	BP	50
CDR1-B-911A---	910	F, G, J, K, M	BP	50
CDR1-B-102A---	1000	F, G, J, K, M	BP	50
CDR1-B-112A---	1100	F, G, J, K, M	BP	50
CDR1-B-122A---	1200	F, G, J, K, M	BP	50
CDR1-B-132A---	1300	F, G, J, K, M	BP	50
CDR1-B-152A---	1500	F, G, J, K, M	BP	50
CDR1-B-162A---	1600	F, G, J, K, M	BP	50
CDR1-B-182A---	1800	F, G, J, K, M	BP	50
CDR1-B-202A---	2000	F, G, J, K, M	BP	50
CDR1-B-222A---	2200	F, G, J, K, M	BP	50
CDR1-B-242A---	2400	F, G, J, K, M	BP	50
CDR1-B-272A---	2700	F, G, J, K, M	BP	50
CDR1-B-302A---	3000	F, G, J, K, M	BP	50
CDR1-B-332A---	3300	F, G, J, K, M	BP	50
CDR1-B-362A---	3600	F, G, J, K, M	BP	50
CDR1-B-392A---	3900	F, G, J, K, M	BP	50
CDR1-B-432A---	4300	F, G, J, K, M	BP	50
CDR1-B-472A---	4700	F, G, J, K, M	BP	50
CDR1-B-502A---	5000	F, G, J, K, M	BP	50
CDR1-B-512A---	5100	F, G, J, K, M	BP	50

1/Complete type designation will include additional symbols to indicate style, voltage-temperature limits, capacitance tolerance (where applicable), termination finish ("M" or "N" for style CDR13, and "S", "U", "W", "Y" or "Z" for style CDR14) and failure rate level.

*C=200V; E=500V.

‡C=200V; D=300V.



RF/Microwave Capacitors

RF/Microwave Multilayer Capacitors (MLC)

Performance Curves



TYPICAL Q vs. FREQUENCY
AQ11/12
MIL-PRF-55681E - BG
STANDARD - M

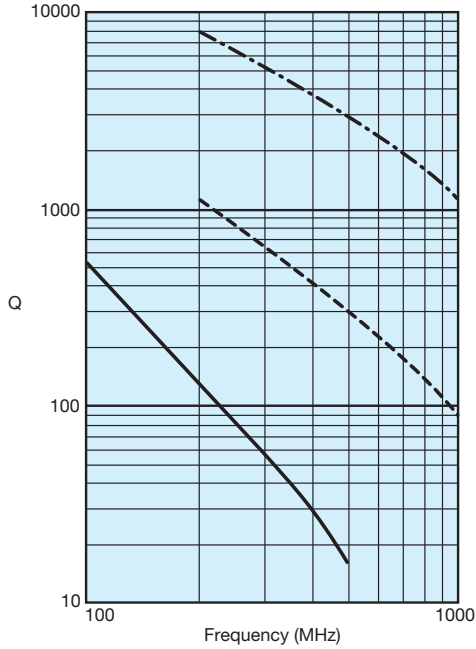

AVX CORPORATION
 - - - 1 Picofarad - - - 10 Picofarad — 100 Picofarad

TYPICAL ESR vs. FREQUENCY
AQ11/12
MIL-PRF-55681E - BG
STANDARD - M

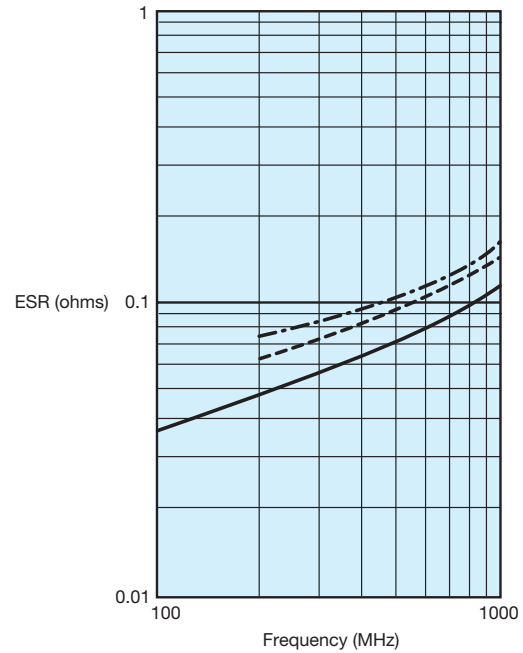

AVX CORPORATION
 - - - 3.3 Picofarad - - - 10 Picofarad — 100 Picofarad

TYPICAL Q vs. CAPACITANCE
AQ11/12
MIL-PRF-55681E - BG
STANDARD - M

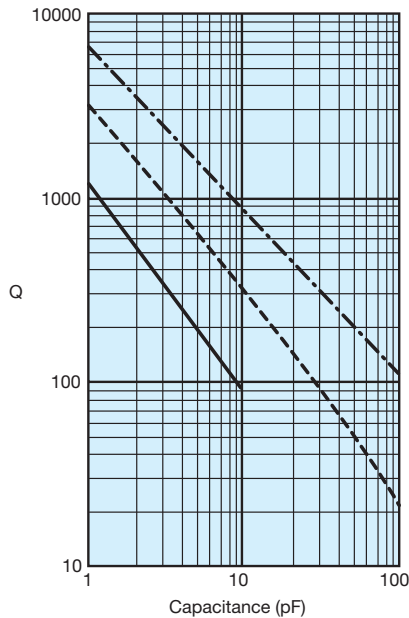

AVX CORPORATION
 - - - 250 MHz - - - 500 MHz — 1000 MHz

TYPICAL ESR vs. CAPACITANCE
AQ11/12
MIL-PRF-55681E - BG
STANDARD - M

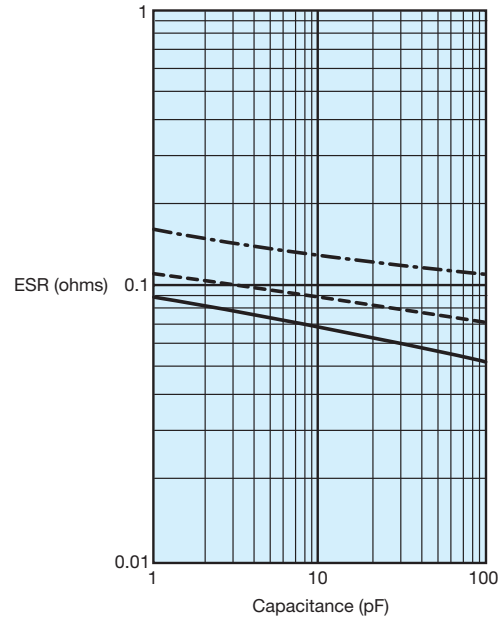

AVX CORPORATION
 — 250 MHz - - - 500 MHz - - - 1000 MHz

RF/Microwave Capacitors

RF/Microwave Multilayer Capacitors (MLC)

Performance Curves



TYPICAL Q vs. FREQUENCY
AQ13/14
MIL-PRF-55681E - BG
STANDARD - M

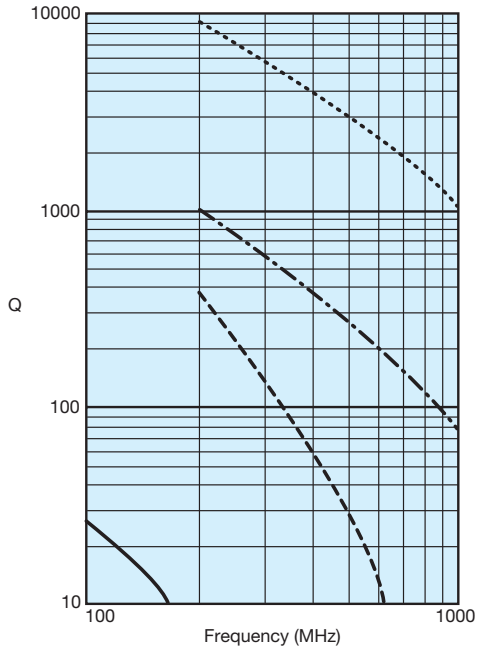

AVX CORPORATION
 - - - - 1 Picofarad - - - - 10 Picofarad - - - - 47 Picofarad - - - - 330 Picofarad

TYPICAL ESR vs. FREQUENCY
AQ13/14
MIL-PRF-55681E - BG
STANDARD - M

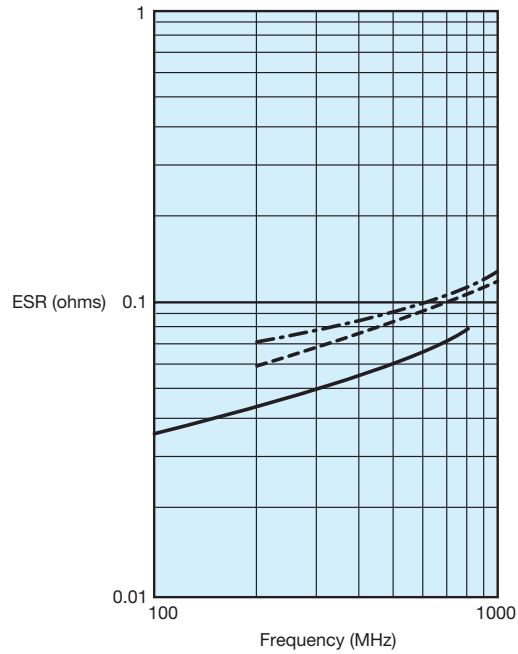

AVX CORPORATION
 - - - - 1 Picofarad - - - - 15 Picofarad - - - - 100 Picofarad

TYPICAL Q vs. CAPACITANCE
AQ13/14
MIL-PRF-55681E - BG
STANDARD - M

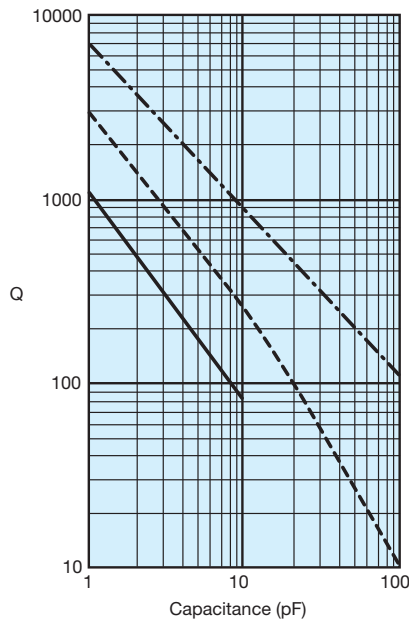

AVX CORPORATION
 - - - - 250 MHz - - - - 500 MHz - - - - 1000 MHz

TYPICAL ESR vs. CAPACITANCE
AQ13/14
MIL-PRF-55681E - BG
STANDARD - M

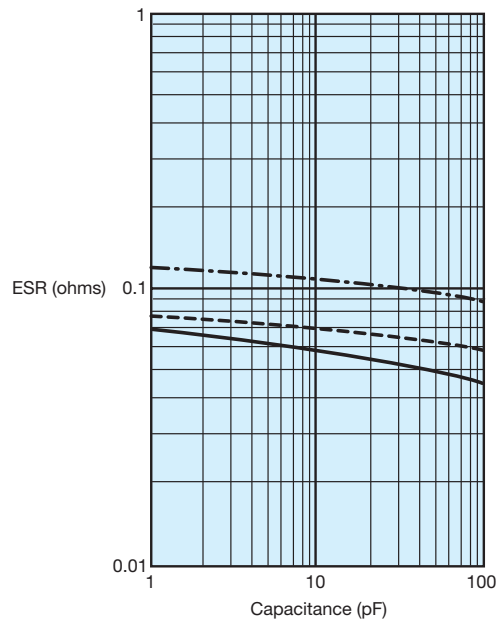

AVX CORPORATION
 - - - - 250 MHz - - - - 500 MHz - - - - 1000 MHz

RF/Microwave Capacitors

RF/Microwave Multilayer Capacitors (MLC)

Performance Curves



TYPICAL Q vs. FREQUENCY
AQ11/12
MIL-PRF-55681E - BP
STANDARD - A

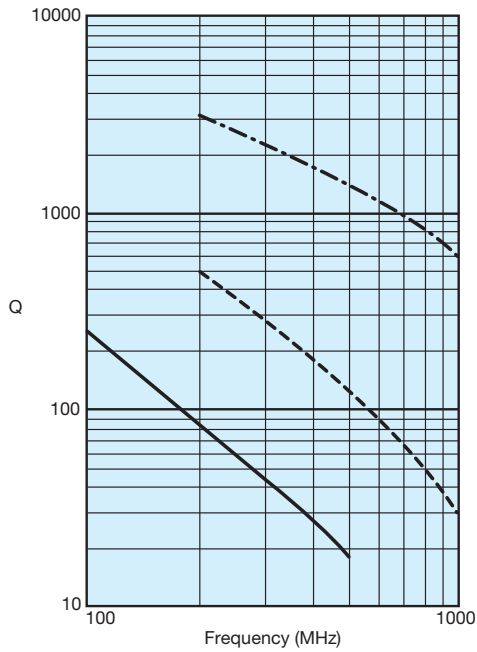

AVX CORPORATION
 --- 1 Picofarad - - - 15 Picofarad — 100 Picofarad

TYPICAL ESR vs. FREQUENCY
AQ13/14
MIL-PRF-55681E - BP
STANDARD - A

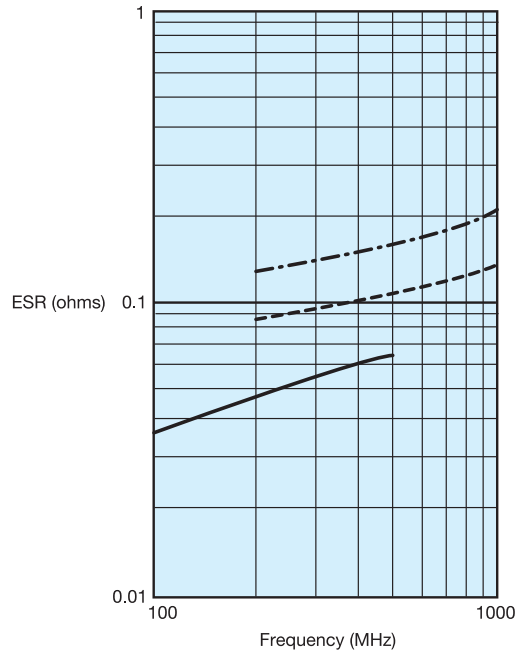

AVX CORPORATION
 --- 15 Picofarad - - - 47 Picofarad — 100 Picofarad

TYPICAL Q vs. CAPACITANCE
AQ11/12
MIL-PRF-55681E - BP
STANDARD - A

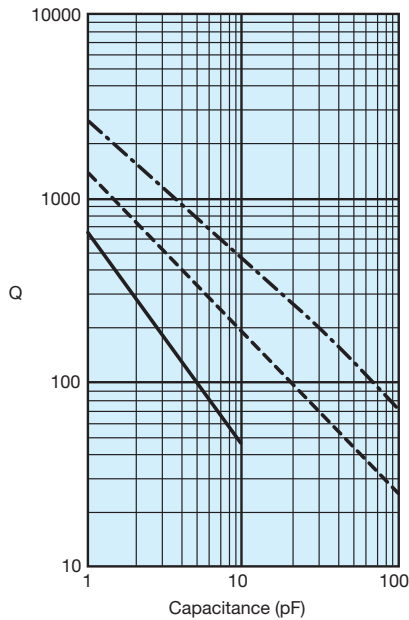

AVX CORPORATION
 --- 250 MHz - - - 500 MHz — 1000 MHz

TYPICAL ESR vs. CAPACITANCE
AQ11/12
MIL-PRF-55681E - BP
STANDARD - A

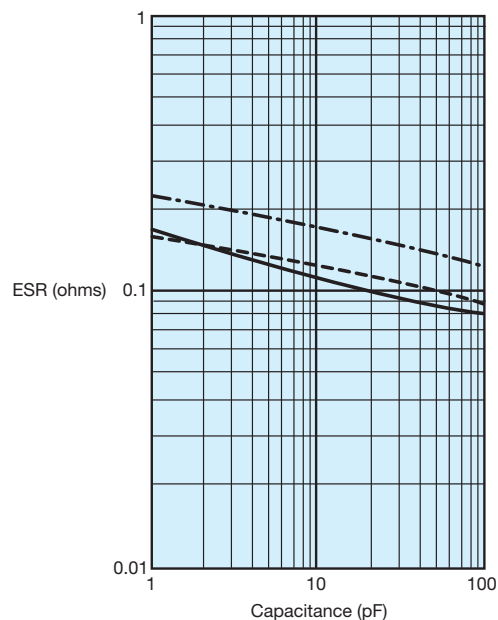

AVX CORPORATION
 — 250 MHz - - - 500 MHz --- 1000 MHz



The Important Information/Disclaimer is incorporated in the catalog where these specifications came from or available online at www.avx.com/disclaimer/ by reference and should be reviewed in full before placing any order.

RF/Microwave Capacitors

RF/Microwave Multilayer Capacitors (MLC)

Performance Curves



TYPICAL Q vs. FREQUENCY
AQ13/14
MIL-PRF-55681E - BP
STANDARD - A

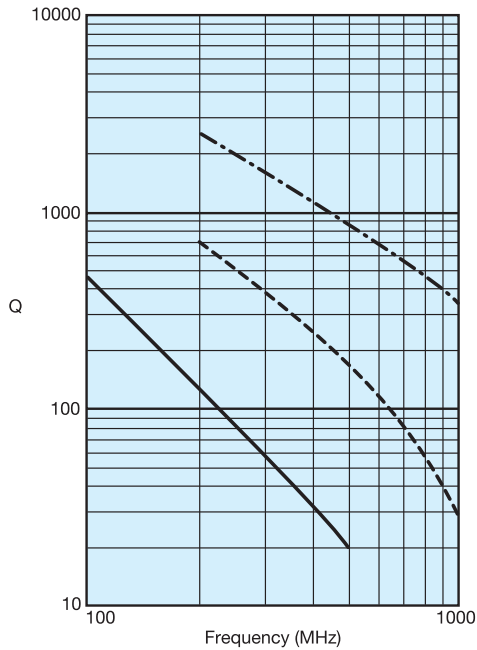

AVX CORPORATION
 - - - 2 Picofarad - - - 15 Picofarad — 100 Picofarad

TYPICAL ESR vs. FREQUENCY
AQ13/14
MIL-PRF-55681E - BP
STANDARD - A

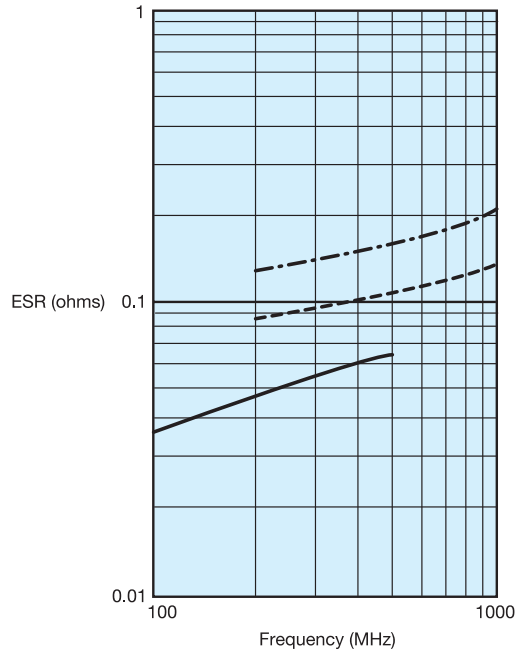

AVX CORPORATION
 - - - 15 Picofarad - - - 47 Picofarad — 100 Picofarad

TYPICAL Q vs. CAPACITANCE
AQ13/14
MIL-PRF-55681E - BP
STANDARD - A

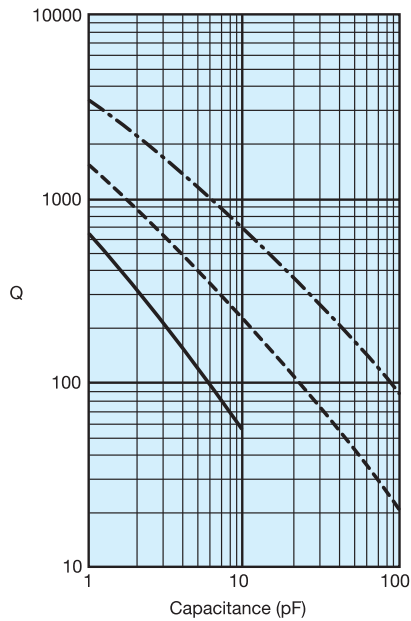

AVX CORPORATION
 - - - 250 MHz - - - 500 MHz — 1000 MHz

TYPICAL ESR vs. CAPACITANCE
AQ13/14
MIL-PRF-55681E - BP
STANDARD - A

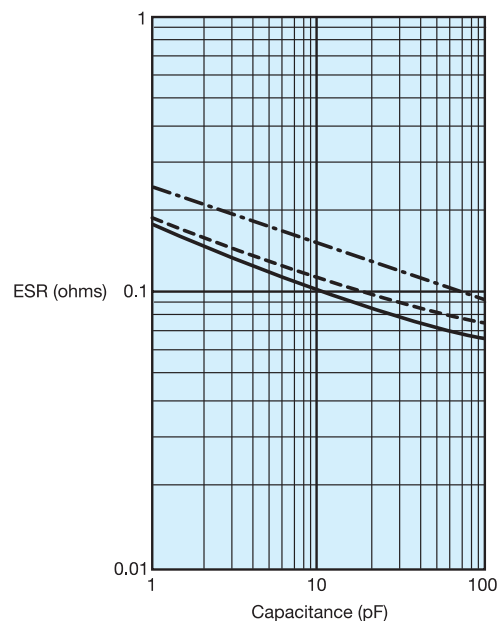

AVX CORPORATION
 — 250 MHz - - - 500 MHz - - - 1000 MHz

TYPICAL RESONANT FREQUENCY vs. CAPACITANCE
AVX AQ11-14 (CDR11-14)

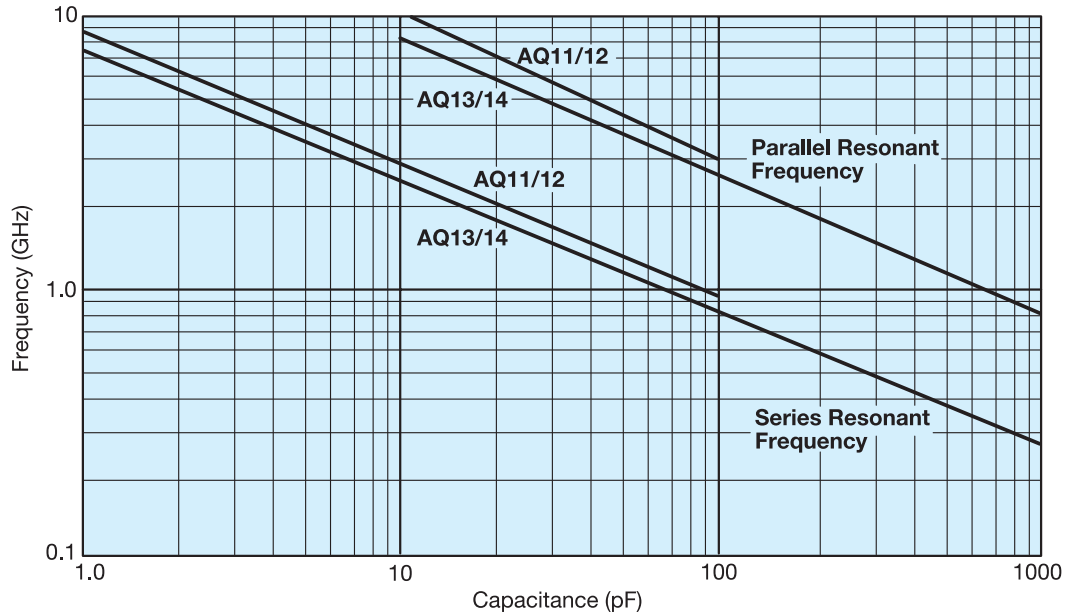

TYPICAL RESONANT FREQUENCY vs. CAPACITANCE AVX 0603

