

LT8362 Low I_Q, Inverting Regulator with 2A, 60V Switch

DESCRIPTION

Demonstration circuit 2517A features the **LT[®]8362** in a CUK configuration. It operates with a switching frequency of 2MHz and is designed to convert a 4.5V to 42V source to -12V, with up to 1A output current (depending on input voltage). Refer to Figure 4 for load current versus input voltage. The LT8362 can operate with inputs as high as 60V, however, in this demo circuit, the input is limited by the maximum voltage across the switch ($|V_{OUT}| + V_{IN} < 60V$).

The demo board contains a selectable jumper, JP1, to aid in the selection of the desired Sync pin mode of operation. The default setting is Burst Mode[®] operation.

All registered trademarks and trademarks are the property of their respective owners.

This layout is optimized for good EMI performance and small solution size. Input and output filters and an optimized power switching loop, comprised of C11 and C12 are necessary to pass CISPR 25 Class 5 emissions, and are added by default. These components can be excluded in applications not requiring noise immunity. Radiated emissions plots are included in this manual.

The data sheet gives a complete description of the device, operation and application information. The data sheet must be read in conjunction with this demo manual.

Design files for this circuit board are available at <http://www.linear.com/demo/DC2517A>

PERFORMANCE SUMMARY Specifications are at T_A = 25°C

SYMBOL	PARAMETER	CONDITIONS	MIN	TYP	MAX	UNITS
V _{IN}	Input Supply Range		4.5		42	V
V _{OUT}	Output Voltage Range	V _{IN} = 12V, I _{LOAD} = 750A	-11.64	-12	-12.36	V
Ripple		V _{IN} = 12V, I _{LOAD} = 750m A		20		mV
Efficiency		V _{IN} = 12V, I _{LOAD} = 750 mA		85		%
Switching Frequency				2		MHz

QUICK START PROCEDURE

Demo circuit 2517A is easy to set up to evaluate the performance of the LT8362. Refer to Figure 1 for proper measurement equipment setup and follow the procedure below:

NOTE: When measuring the input or output voltage ripple, care must be taken to avoid a long ground lead on the oscilloscope probe. Measure the input or output voltage ripple by touching the probe tip directly across the V_{IN} or V_{OUT} and GND terminals. See Figure 2 for proper scope probe technique.

1. With power off, connect the input power supply to V_{IN} and GND.
2. Turn on the power at the input.

NOTE: Make sure that the input voltage does not exceed 42V.

3. Check for the proper output voltage. If there is no output, temporarily disconnect the load to make sure that the load is not set too high.
4. Once the proper output voltages are established, adjust the load within the operating range and observe the output voltage regulation, ripple voltage, efficiency and other parameters.

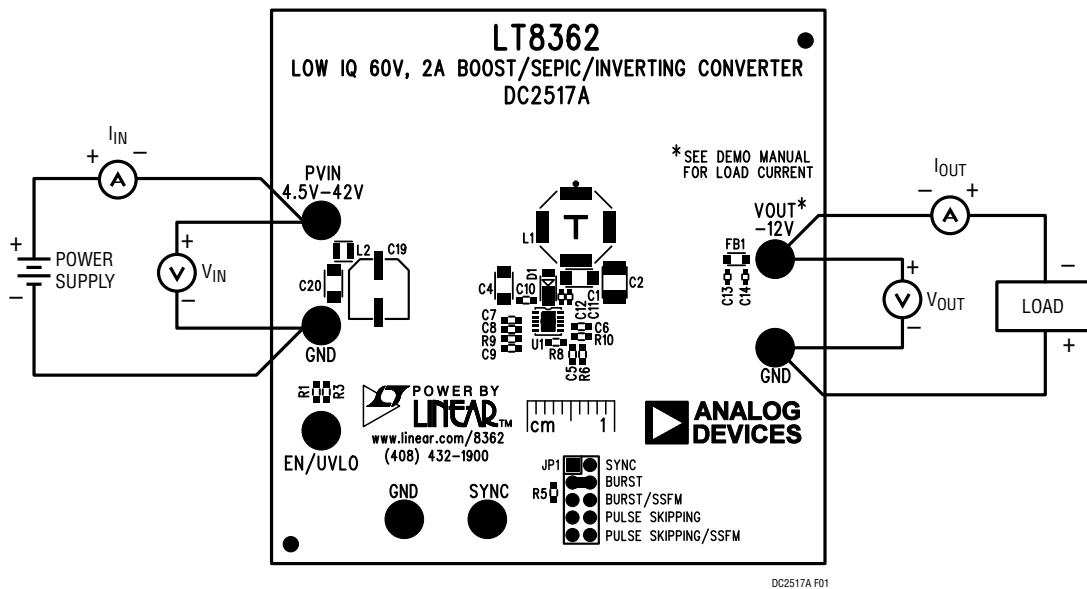

Figure 1. DC2517A Proper Equipment Setup

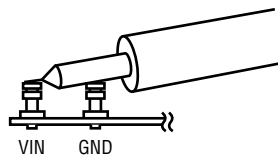

Figure 2. Proper Scope Probe Positioning for Output Ripple Measurement

QUICK START PROCEDURE

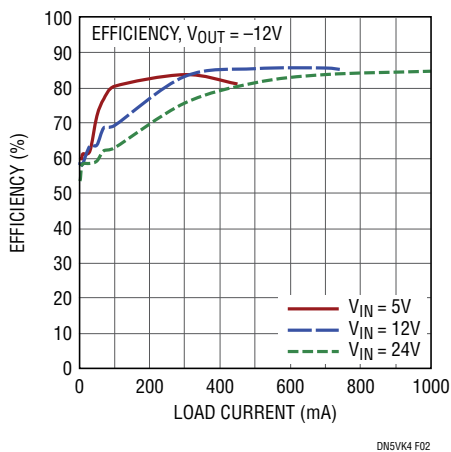

Figure 3. Efficiency vs Load Current

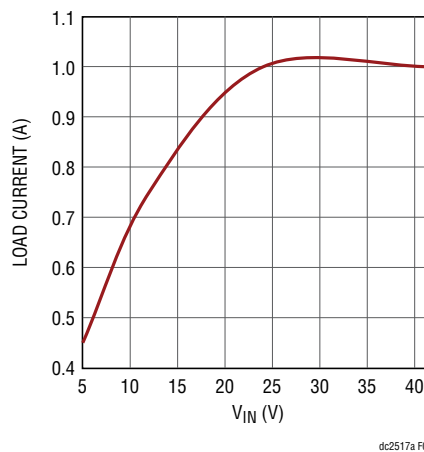

Figure 4. Load Current vs Input Voltage

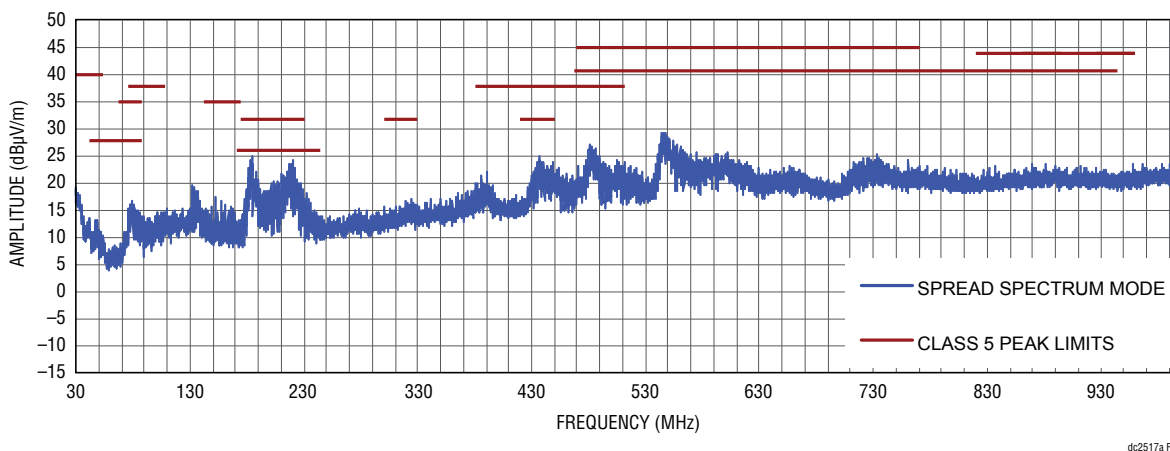

Figure 5. CISPR25 Radiated Emission Test (Peak Detection, Vertical Polarization) $V_{IN} = 12V$

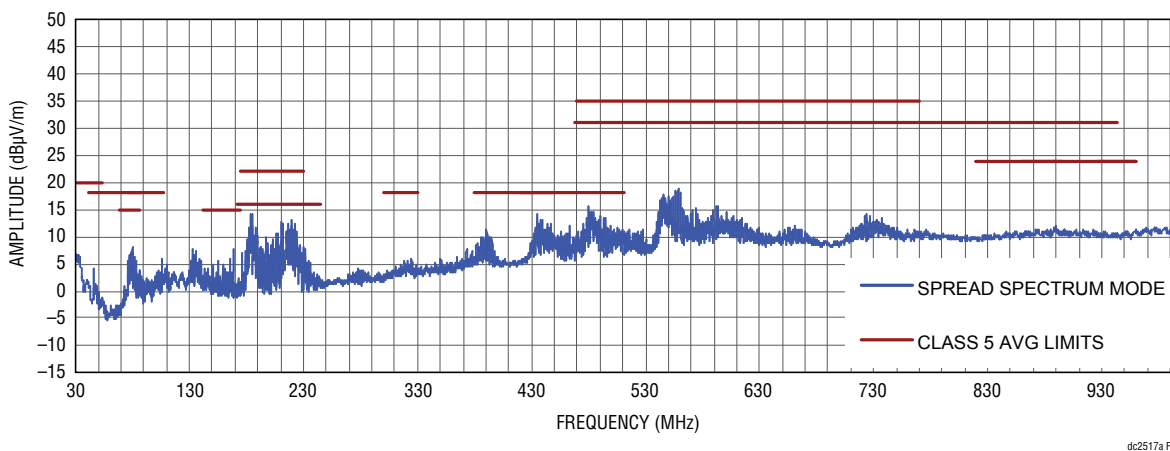

Figure 6. CISPR25 Radiated Emission Test (Average Detection, Vertical Polarization) $V_{IN} = 12V$

DEMO MANUAL DC2517A

PARTS LIST

ITEM	QTY	REFERENCE	PART DESCRIPTION	MANUFACTURER/PART NUMBER
Required Circuit Components				
1	1	C1	CAP, 1 μ F, X7R, 100V, 10%, 1206	MURATA, GRM31CR72A105KA01L
2	1	C2	CAP, 10 μ F, X7R, 50V, 10%, 1210	MURATA, GRM32ER71H106KA12L
3	1	C4	CAP, 10 μ F, X5R, 50V, 10%, 1206	MURATA, GRM31CR61H106KA12L
5	1	C6	CAP, 0.22 μ F, X7R, 25V, 10%, 0603	MURATA, GRM188R71E224KA88D
6	1	C7	CAP, 1 μ F, X5R, 25V, 10%, 0603	MURATA, GRM188R61E105KA12D
7	1	C9	CAP, 1500pF, X7R, 25V, 10%, 0603	AVX, 06033C152KAT2A
8	1	C10	CAP, 1 μ F, X5R, 50V, 10%, 0603	MURATA, GRM188R61H105KAALD
9	4	C11, C12, C13, C14	CAP, 0.1 μ F, X5R, 100V, 10%, 0402	MURATA, GRM155R62A104KE14D
10	1	C19	CAP, 33 μ F, ALUM. ELECT., 50V, 20%, 6.3mm \times 7.7mm	SUN ELECTRONIC INDUSTRIES CORP, 50CE33PCS
11	1	C20	CAP, 4.7 μ F, X7R, 50V, 10%, 1206	AVX, 12065C475KAT2A
12	1	D1	DIODE, SCHOTTKY, 60V, 2.0A, PowerDI 123	DIODES INC., DFSL260-7
13	1	FB1	IND., 600 Ω , FERRITE BEAD, 25%, 2A, 0805	WURTH ELEKTRONIK, 742792040
14	1	L1	IND., 6.8 μ H, PWR, 30%, 1.25A	WURTH ELEKTRONIK, 74489430068
15	1	L2	IND., 0.47 μ H, PWR, 20%, 2.1A, 0.04 Ω , 0806	WURTH ELEKTRONIK, 74479876147
16	2	R1, R6	RES., 1M Ω , 1%, 1/10W, 0603	VISHAY, CRCW06031M00FKEA
17	1	R3	RES., 732k Ω , 1%, 1/10W, 0603	VISHAY, CRCW0603732KFKEA
18	1	R5	RES., 100k Ω , 1%, 1/10W, 0603	VISHAY, CRCW0603100KFKEA
19	1	R8	RES., 71.5k Ω , 1%, 1/10W, 0603	VISHAY, CRCW060371K5FKEA
20	1	R9	RES., 40.2k Ω , 1%, 1/10W, 0603	VISHAY,
21	1	R10	RES., 20k Ω , 1%, 1/10W, 0603	VISHAY, CRCW060320K0FKEA
22	1	U1	IC, BOOST/SEPIC/INVERTG CONVERTER, 3 \times 3mm, DFN	LINEAR TECH., LT8362EDD#PBF
23	1	PCB1	PCB, 600-DC2517A	MAO BANG, 600-DC2517A
Optional Demo Board Circuit Components				
1	0	C5, C8(OPT)	CAP, OPTION, 0603	
Hardware: For Demo Board Only				
1	7	E1, E2, E3, E4, E5, E6, E7	TEST POINT, TURRET, 0.094", MTG. HOLE	MILL-MAX, 2501-2-00-80-00-00-07-0
2	1	JP1	CONN., HDR, MALE, 2 \times 5, 2mm, STR, THT	WURTH ELEKTRONIK, 62001021121
3	1	XJP1	CONN., SHUNT, FEMALE, 2 POS, 2mm	WURTH ELEKTRONIK, 60800213421

SCHEMATIC DIAGRAM

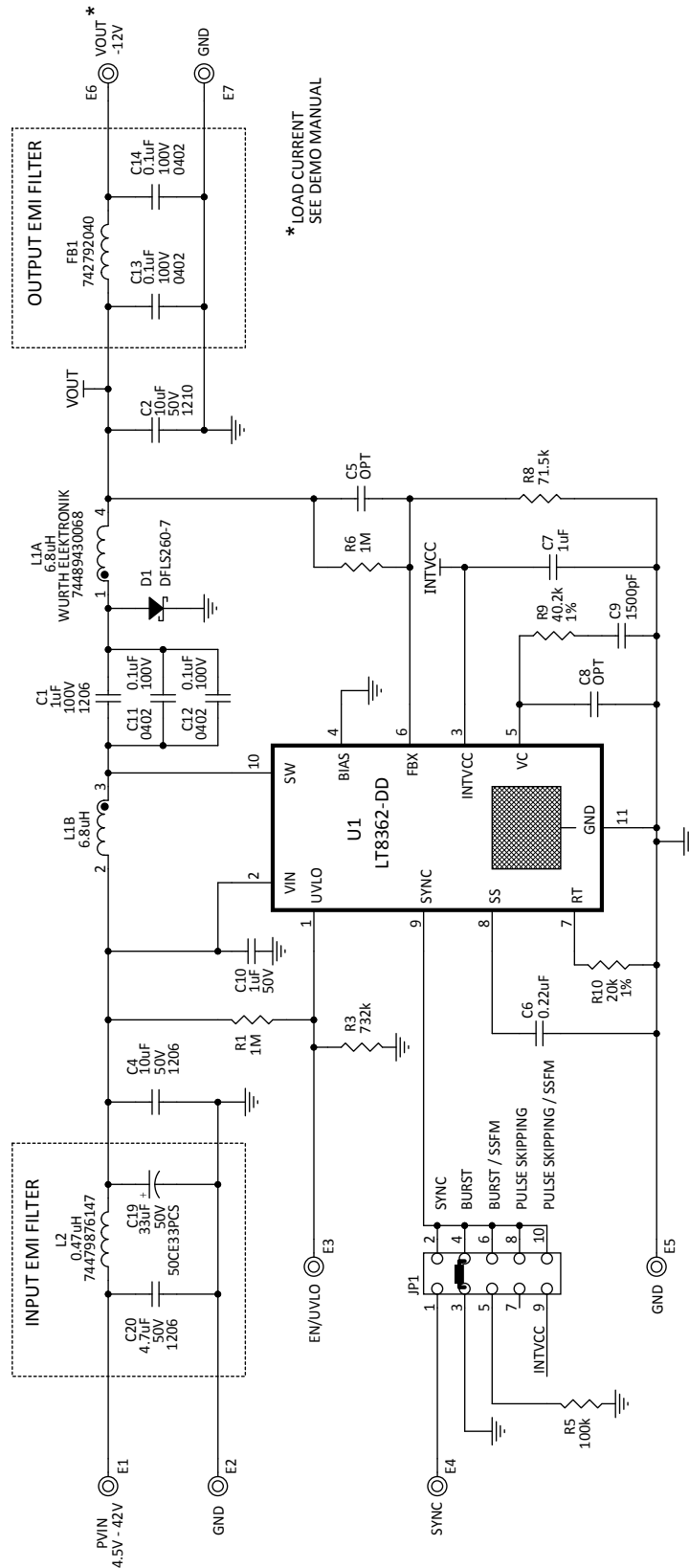

* LOAD CURRENT
SEE DEMO MANUAL

NOTES: UNLESS OTHERWISE SPECIFIED
 1. ALL RESISTORS ARE 0603.
 ALL CAPACITORS ARE 0603.



ESD Caution

ESD (electrostatic discharge) sensitive device. Charged devices and circuit boards can discharge without detection. Although this product features patented or proprietary protection circuitry, damage may occur on devices subjected to high energy ESD. Therefore, proper ESD precautions should be taken to avoid performance degradation or loss of functionality.

Legal Terms and Conditions

By using the evaluation board discussed herein (together with any tools, components documentation or support materials, the "Evaluation Board"), you are agreeing to be bound by the terms and conditions set forth below ("Agreement") unless you have purchased the Evaluation Board, in which case the Analog Devices Standard Terms and Conditions of Sale shall govern. Do not use the Evaluation Board until you have read and agreed to the Agreement. Your use of the Evaluation Board shall signify your acceptance of the Agreement. This Agreement is made by and between you ("Customer") and Analog Devices, Inc. ("ADI"), with its principal place of business at One Technology Way, Norwood, MA 02062, USA. Subject to the terms and conditions of the Agreement, ADI hereby grants to Customer a free, limited, personal, temporary, non-exclusive, non-sublicensable, non-transferable license to use the Evaluation Board FOR EVALUATION PURPOSES ONLY. Customer understands and agrees that the Evaluation Board is provided for the sole and exclusive purpose referenced above, and agrees not to use the Evaluation Board for any other purpose. Furthermore, the license granted is expressly made subject to the following additional limitations: Customer shall not (i) rent, lease, display, sell, transfer, assign, sublicense, or distribute the Evaluation Board; and (ii) permit any Third Party to access the Evaluation Board. As used herein, the term "Third Party" includes any entity other than ADI, Customer, their employees, affiliates and in-house consultants. The Evaluation Board is NOT sold to Customer; all rights not expressly granted herein, including ownership of the Evaluation Board, are reserved by ADI. CONFIDENTIALITY. This Agreement and the Evaluation Board shall all be considered the confidential and proprietary information of ADI. Customer may not disclose or transfer any portion of the Evaluation Board to any other party for any reason. Upon discontinuation of use of the Evaluation Board or termination of this Agreement, Customer agrees to promptly return the Evaluation Board to ADI. ADDITIONAL RESTRICTIONS. Customer may not disassemble, decompile or reverse engineer chips on the Evaluation Board. Customer shall inform ADI of any occurred damages or any modifications or alterations it makes to the Evaluation Board, including but not limited to soldering or any other activity that affects the material content of the Evaluation Board. Modifications to the Evaluation Board must comply with applicable law, including but not limited to the RoHS Directive. TERMINATION. ADI may terminate this Agreement at any time upon giving written notice to Customer. Customer agrees to return to ADI the Evaluation Board at that time. LIMITATION OF LIABILITY. THE EVALUATION BOARD PROVIDED HEREUNDER IS PROVIDED "AS IS" AND ADI MAKES NO WARRANTIES OR REPRESENTATIONS OF ANY KIND WITH RESPECT TO IT. ADI SPECIFICALLY DISCLAIMS ANY REPRESENTATIONS, ENDORSEMENTS, GUARANTEES, OR WARRANTIES, EXPRESS OR IMPLIED, RELATED TO THE EVALUATION BOARD INCLUDING, BUT NOT LIMITED TO, THE IMPLIED WARRANTY OF MERCHANTABILITY, TITLE, FITNESS FOR A PARTICULAR PURPOSE OR NON-INFRINGEMENT OF INTELLECTUAL PROPERTY RIGHTS. IN NO EVENT WILL ADI AND ITS LICENSORS BE LIABLE FOR ANY INCIDENTAL, SPECIAL, INDIRECT, OR CONSEQUENTIAL DAMAGES RESULTING FROM CUSTOMER'S POSSESSION OR USE OF THE EVALUATION BOARD, INCLUDING BUT NOT LIMITED TO LOST PROFITS, DELAY COSTS, LABOR COSTS OR LOSS OF GOODWILL. ADI'S TOTAL LIABILITY FROM ANY AND ALL CAUSES SHALL BE LIMITED TO THE AMOUNT OF ONE HUNDRED US DOLLARS (\$100.00). EXPORT. Customer agrees that it will not directly or indirectly export the Evaluation Board to another country, and that it will comply with all applicable United States federal laws and regulations relating to exports. GOVERNING LAW. This Agreement shall be governed by and construed in accordance with the substantive laws of the Commonwealth of Massachusetts (excluding conflict of law rules). Any legal action regarding this Agreement will be heard in the state or federal courts having jurisdiction in Suffolk County, Massachusetts, and Customer hereby submits to the personal jurisdiction and venue of such courts. The United Nations Convention on Contracts for the International Sale of Goods shall not apply to this Agreement and is expressly disclaimed.