

## FEATURES

### Triaxial, digital gyroscope

$\pm 2000^\circ/\text{sec}$  dynamic range

8.1°/hr in-run bias stability

0.29°/√hr angular random walk, x-axis and y-axis, 1  $\sigma$

$\pm 0.25^\circ$  axis to axis misalignment error

### Triaxial, digital accelerometer, $\pm 392 \text{ m/sec}^2$ dynamic range

125  $\mu\text{m/sec}^2$  in-run bias stability

### Triaxial, delta angle and delta velocity outputs

### Factory calibrated sensitivity, bias, and axial alignment

Calibration temperature range:  $-10^\circ\text{C}$  to  $+75^\circ\text{C}$

### SPI compatible data communications

### Programmable operation and control

Automatic and manual bias correction controls

Data ready indicator for synchronous data acquisition

External sync modes: direct, scaled, and output

On demand self-test of inertial sensors

On demand self-test of flash memory

### Single-supply operation (VDD): 3.0 V to 3.6 V

### 19,600 $\text{m/sec}^2$ mechanical shock survivability

### Operating temperature range: $-25^\circ\text{C}$ to $+85^\circ\text{C}$

## APPLICATIONS

Navigation, stabilization, and instrumentation

Unmanned and autonomous vehicles

Smart agriculture and construction machinery

Factory/industrial automation, robotics

Virtual/augmented reality

Internet of Moving Things

## GENERAL DESCRIPTION

The ADIS16500 is a precision, miniature microelectromechanical system (MEMS) inertial measurement unit (IMU) that includes a triaxial gyroscope and a triaxial accelerometer. Each inertial sensor in the ADIS16500 combines with signal conditioning that optimizes dynamic performance. The factory calibration characterizes each sensor for sensitivity, bias, alignment, linear acceleration (gyroscope bias), and point of percussion (accelerometer location). As a result, each sensor has dynamic compensation formulas that provide accurate sensor measurements over a broad set of conditions.

The ADIS16500 provides a simplified, cost effective method for integrating accurate, multi-axis inertial sensing into industrial systems, especially when compared with the complexity and investment associated with discrete designs. All necessary motion testing and calibration are part of the production process at the factory, greatly reducing system integration time. Tight orthogonal alignment simplifies inertial frame alignment in navigation systems. The serial peripheral interface (SPI) and register structure provide a simple interface for data collection and configuration control.

The ADIS16500 is available in a 100-ball, ball grid array (BGA) package that is approximately 15 mm  $\times$  15 mm  $\times$  5 mm.

## FUNCTIONAL BLOCK DIAGRAM

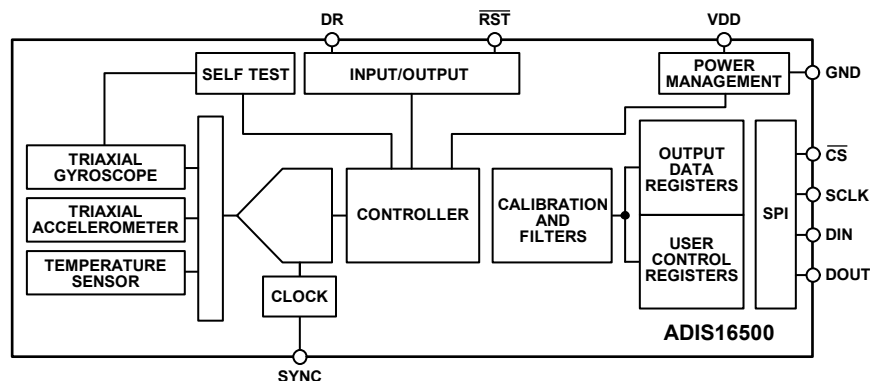

Figure 1.

Rev. A

### Document Feedback

Information furnished by Analog Devices is believed to be accurate and reliable. However, no responsibility is assumed by Analog Devices for its use, nor for any infringements of patents or other rights of third parties that may result from its use. Specifications subject to change without notice. No license is granted by implication or otherwise under any patent or patent rights of Analog Devices. Trademarks and registered trademarks are the property of their respective owners.

One Technology Way, P.O. Box 9106, Norwood, MA 02062-9106, U.S.A.  
 Tel: 781.329.4700 ©2019–2020 Analog Devices, Inc. All rights reserved.  
 Technical Support [www.analog.com](http://www.analog.com)

## TABLE OF CONTENTS

Features .....	1	SPI .....	17
Applications .....	1	Data Ready (DR) .....	17
General Description .....	1	Reading Sensor Data .....	18
Functional Block Diagram .....	1	Burst Read Function .....	19
Revision History .....	2	Latency .....	21
Specifications .....	3	Device Configuration .....	21
Timing Specifications .....	6	Memory Structure .....	21
Absolute Maximum Ratings .....	7	User Register Memory Map .....	22
Thermal Resistance .....	7	User Register Definitions .....	24
ESD Caution .....	7	Gyroscope Data .....	24
Pin Configuration and Function Descriptions .....	8	Delta Angles .....	28
Typical Performance Characteristics .....	11	Delta Velocity .....	29
Gyroscopes .....	11	Calibration .....	31
Accelerometers .....	13	Applications Information .....	37
Theory of Operation .....	15	Assembly and Handling Tips .....	37
Introduction .....	15	Power Supply Considerations .....	38
Clock Control .....	15	Evaluation Tools .....	38
Bartlett Window Filter .....	16	Packaging and Ordering Information .....	40
Calibration .....	16	Outline Dimensions .....	40
Decimation Filter .....	16	Ordering Guide .....	40
Register Structure .....	16		

## REVISION HISTORY

### 6/2020—Rev. 0 to Rev. A

Change to Features Section .....	1
Changes to Table 1 .....	3
Changes to Table 3 and Table 4 .....	7
Changes to Clock Control Section .....	15
Changes to Figure 38 .....	20
Changes to Table 9 .....	23
Changes to Table 11 .....	24
Changes to Table 102, Miscellaneous Control Register (MSC_CTRL) Section, and Table 106 .....	33

Deleted Continuous Bias Estimation (NULL_CNFG) Section, Table 111, and Table 112; Renumbered Sequentially .....	34
Changes to Table 108, Table 110, and Table 112 .....	34
Deleted Bias Correction Update Section .....	35
Changes to Table 113, Table 115, Table 119, and Table 121 .....	35
Changes to Table 130 and Table 132 .....	36
Changes to Figure 38 .....	39

### 10/2019—Revision 0: Initial Version

## SPECIFICATIONS

Case temperature ( $T_c$ ) = 25°C, VDD = 3.3 V, angular rate = 0°/sec, and dynamic range =  $\pm 2000^\circ/\text{sec} \pm 1 g$ , unless otherwise noted. 1 g is the acceleration due to gravity and is assumed to be 9.8 m/sec<sup>2</sup>.

Table 1.

Parameter	Test Conditions/Comments	Min	Typ	Max	Unit
<b>GYROSCOPES</b>					
Dynamic Range		$\pm 2000$			°/sec
Sensitivity	16-bit data format		10		LSB/°/sec
	32-bit data format		655,360		LSB/°/sec
Error over Temperature	$-40^\circ\text{C} \leq T_c \leq +85^\circ\text{C}$ , 1 $\sigma$		$\pm 0.3$		%
Misalignment Error <sup>1</sup>	Axis to axis, $-40^\circ\text{C} \leq T_c \leq +85^\circ\text{C}$ , 1 $\sigma$		$\pm 0.25$		Degrees
Nonlinearity <sup>2</sup>	Full scale (FS) = 2000°/sec		0.2		%FS
<b>Bias</b>					
Repeatability <sup>3</sup>	$-40^\circ\text{C} \leq T_c \leq +85^\circ\text{C}$ , 1 $\sigma$ x-axis and z-axis		0.14		°/sec
	$-40^\circ\text{C} \leq T_c \leq +85^\circ\text{C}$ , 1 $\sigma$ , y-axis		1.4		°/sec
In-Run Bias Stability	X-axis		7.5		°/hr
	Y-axis		8.1		°/hr
	Z-axis		4.9		°/hr
Angular Random Walk	X-axis and y-axis, 1 $\sigma$		0.29		°/√hr
	Z-axis, 1 $\sigma$		0.32		°/√hr
Error over Temperature	$-40^\circ\text{C} \leq T_c \leq +85^\circ\text{C}$ , 1 $\sigma$ , x-axis and z-axis		$\pm 0.3$		°/sec
	$-40^\circ\text{C} \leq T_c \leq +85^\circ\text{C}$ , 1 $\sigma$ , y-axis		$\pm 0.7$		°/sec
Linear Acceleration Effect	X-axis, 1 $\sigma$		$0.572 \times 10^{-3}$		(°/sec)/(m/sec <sup>2</sup> )
	Y-axis, 1 $\sigma$		$1.02 \times 10^{-3}$		(°/sec)/(m/sec <sup>2</sup> )
	Z-axis, 1 $\sigma$		$0.408 \times 10^{-3}$		(°/sec)/(m/sec <sup>2</sup> )
Vibration Rectified Error (VRE)	X-axis, Random vibration, 19.6 m/sec <sup>2</sup> rms, 50 Hz to 2 kHz		$3.1 \times 10^{-6}$		(°/sec)/(m/sec <sup>2</sup> ) <sup>2</sup>
	Y-axis, random vibration, 19.6 m/sec <sup>2</sup> rms, 50 Hz to 2 kHz		$5.6 \times 10^{-6}$		(°/sec)/(m/sec <sup>2</sup> ) <sup>2</sup>
	Z-axis, random vibration, 19.6 m/sec <sup>2</sup> rms, 50 Hz to 2 kHz		$0.3 \times 10^{-6}$		(°/sec)/(m/sec <sup>2</sup> ) <sup>2</sup>
Output Noise	No filtering, 1 $\sigma$ , 25°C				
	X-axis, y-axis		$152 \times 10^{-3}$		°/sec rms
	Z-axis		$181 \times 10^{-3}$		°/sec rms
Rate Noise Density	Frequency = 10 Hz to 40 Hz				
	X-axis and y-axis		$6.1 \times 10^{-3}$		°/sec/√Hz rms
	Z-axis		$7.0 \times 10^{-3}$		°/sec/√Hz rms
3 dB Bandwidth	X-axis and y-axis		573		Hz
	Z-axis		639		Hz
Sensor Resonant Frequency	X-axis, y-axis		66		kHz
	Z-axis		78		kHz
<b>ACCELEROMETERS<sup>4</sup></b>					
Dynamic Range	Each axis	$\pm 392$			m/sec <sup>2</sup>
Sensitivity	32-bit data format		5,351,254		LSB/(m/sec <sup>2</sup> )
Error over Temperature	$-40^\circ\text{C} \leq T_c \leq +85^\circ\text{C}$ , 1 $\sigma$		$\pm 0.06$		%
Repeatability <sup>3</sup>	$-40^\circ\text{C} \leq T_c \leq +85^\circ\text{C}$ , 1 $\sigma$		$\pm 0.1$		%
Misalignment Error	Axis to axis, $-40^\circ\text{C} \leq T_c \leq +85^\circ\text{C}$ , 1 $\sigma$		$\pm 0.05$		Degrees
Nonlinearity	Best fit straight line, $\pm 19.6 \text{ m/sec}^2$		0.25		%FS
	Best fit straight line, $\pm 78.4 \text{ m/sec}^2$ , x-axis		0.5		%FS
	Best fit straight line, $\pm 78.4 \text{ m/sec}^2$ , y-axis and z-axis		1.5		%FS

Parameter	Test Conditions/Comments	Min	Typ	Max	Unit
Bias					
Repeatability <sup>3</sup>	$-40^{\circ}\text{C} \leq T_c \leq +85^{\circ}\text{C}$ , $1 \sigma$		$58.8 \times 10^{-3}$		m/sec <sup>2</sup>
In-Run Bias Stability	$1 \sigma$				
X-Axis and Y-Axis			$125 \times 10^{-6}$		m/sec <sup>2</sup>
Z-Axis			$134 \times 10^{-6}$		m/sec <sup>2</sup>
Velocity Random Walk	$1 \sigma$				
X-Axis and Y-Axis			0.039		m/sec/ $\sqrt{\text{hr}}$
Z-Axis			0.033		m/sec/ $\sqrt{\text{hr}}$
Error over Temperature	$-40^{\circ}\text{C} \leq T_c \leq +85^{\circ}\text{C}$ , $1 \sigma$		$\pm 14.7 \times 10^{-3}$		m/sec <sup>2</sup>
Output Noise	No filtering				
X-Axis and Y-Axis			$24.8 \times 10^{-3}$		m/sec <sup>2</sup> rms
Z-Axis			$20.3 \times 10^{-3}$		m/sec <sup>2</sup> rms
Noise Density	$f = 10 \text{ Hz to } 40 \text{ Hz}$ , no filtering				
X-Axis and Y-Axis			$880 \times 10^{-6}$		m/sec <sup>2</sup> / $\sqrt{\text{Hz}}$ rms
Z-Axis			$732 \times 10^{-6}$		m/sec <sup>2</sup> / $\sqrt{\text{Hz}}$ rms
3 dB Bandwidth			750		Hz
Sensor Resonant Frequency	X-axis and y-axis		5.5		kHz
	Z-axis		5		kHz
TEMPERATURE SENSOR					
Scale Factor	Output = 0x0000 at 0°C ( $\pm 5^{\circ}\text{C}$ )		0.1		°C/LSB
LOGIC INPUTS <sup>5</sup>					
Input Voltage					
High, $V_{IH}$		2.0			V
Low, $V_{IL}$				0.8	V
$\overline{\text{RST}}$ Pulse Width		1			$\mu\text{s}$
Input Current					
Logic 1, $I_{IH}$	$V_{IH} = 3.3 \text{ V}$			10	$\mu\text{A}$
Logic 0, $I_{IL}$	$V_{IL} = 0 \text{ V}$			10	$\mu\text{A}$
All Pins Except $\overline{\text{RST}}$				10	$\mu\text{A}$
$\overline{\text{RST}}$ Pin			0.33		mA
Input Capacitance, $C_{IN}$			10		pF
DIGITAL OUTPUTS					
Output Voltage					
High, $V_{OH}$	Source current ( $I_{SOURCE}$ ) = 0.5 mA	2.4			V
Low, $V_{OL}$	Sink current ( $I_{SINK}$ ) = 2.0 mA			0.4	V
FLASH MEMORY					
Data Retention <sup>7</sup>	Endurance <sup>6</sup> $T_J = 85^{\circ}\text{C}$	10,000 20			Cycles Years
FUNCTIONAL TIMES <sup>8</sup>	Time until data is available				
Power-On Start-Up Time			310		ms
Reset Recovery Time <sup>9</sup>	GLOB_CMD, Bit 7 = 1 (see Table 112)		255		ms
Factory Calibration Restore	GLOB_CMD, Bit 1 = 1 (see Table 112)		136		ms
Flash Memory Backup	GLOB_CMD, Bit 3 = 1 (see Table 112)		70		ms
Flash Memory Test Time	GLOB_CMD, Bit 4 = 1 (see Table 112)		30		ms
Self Test Time <sup>10</sup>	GLOB_CMD, Bit 2 = 1 (see Table 112)		24		ms

Parameter	Test Conditions/Comments	Min	Typ	Max	Unit
CONVERSION RATE			2000		SPS
Initial Clock Accuracy			3		%
Sync Input Clock		1.9		2.1	kHz
POWER SUPPLY, VDD	Operating voltage range	3.0		3.6	V
Power Supply Current <sup>11</sup>	Normal mode, VDD = 3.3 V		44	55	mA

<sup>1</sup> Cross axis sensitivity is the sine of this number.

<sup>2</sup> This measurement is based on the deviation from a best fit linear model.

<sup>3</sup> Bias repeatability provides an estimate for long-term drift in the bias, as observed during 500 hours of high temperature operating life (HTOL) at 105°C.

<sup>4</sup> All specifications associated with the accelerometers relate to the full-scale range of  $\pm 8g$ , unless otherwise noted.

<sup>5</sup> The digital input/output signals use a 3.3 V system.

<sup>6</sup> Endurance is qualified as per JEDEC Standard 22, Method A117, measured at -40°C, +25°C, +85°C, and +125°C.

<sup>7</sup> The data retention specification assumes a junction temperature ( $T_j$ ) of 85°C per JEDEC Standard 22, Method A117. Data retention lifetime decreases with  $T_j$ .

<sup>8</sup> These times do not include thermal settling and internal filter response times, which may affect overall accuracy.

<sup>9</sup> The  $\overline{RST}$  line must be in a low state for at least 10  $\mu s$  to ensure a proper reset initiation and recovery.

<sup>10</sup> The self test time can extend when using external clock rates lower than 2000 Hz.

<sup>11</sup> Power supply current transients can reach 100 mA during initial startup or reset recovery.

**TIMING SPECIFICATIONS**

T<sub>A</sub> = 25°C, VDD = 3.3 V, unless otherwise noted.

**Table 2.**

Parameter	Description	Normal Mode			Burst Read Mode			Unit
		Min	Typ	Max	Min	Typ	Max	
f <sub>SCLK</sub>	Serial clock	0.1		2.1	0.1		1.1	MHz
t <sub>STALL</sub>	Stall period between data	16			N/A <sup>1</sup>			μs
t <sub>READRATE</sub>	Read rate	24						μs
t <sub>CS</sub>	Chip select to SCLK edge	200			200			ns
t <sub>DAV</sub>	DOUT valid after SCLK edge			25			25	ns
t <sub>DSU</sub>	DIN setup time before SCLK rising edge	25			25			ns
t <sub>DHD</sub>	DIN hold time after SCLK rising edge	50			50			ns
t <sub>SCLKR</sub> , t <sub>SCLKF</sub>	SCLK rise/fall times		5	12.5		5	12.5	ns
t <sub>DR</sub> , t <sub>DF</sub>	DOUT rise/fall times		5	12.5		5	12.5	ns
t <sub>SFS</sub>	CS high after SCLK edge	0			0			ns
t <sub>1</sub>	Input sync positive pulse width; direct sync mode, MSC_CTRL[3:2] = 01 (binary, see Table 106)	5			5			μs
t <sub>STDR</sub>	Input sync to data ready valid transition, no SPI traffic, direct sync mode, MSC_CTRL[3:2] = 01 (binary, see Table 106)		305			305		μs
	Input sync to data ready valid transition, full SPI traffic <sup>2</sup> , direct sync mode, MSC_CTRL[3:2] = 01 (binary, see Table 106)		405			405		μs
t <sub>NV</sub>	Data invalid time		23			23		μs
t <sub>2</sub>	Input sync period	500			500			μs

<sup>1</sup> N/A means not applicable.

<sup>2</sup> Full SPI traffic is defined as a transfer of 64 16-bit registers using an SCLK frequency of 2 MHz. Reading the sensor values from the previous data sample proportionally increases the t<sub>STDR</sub> on the current cycle.

**Timing Diagrams**

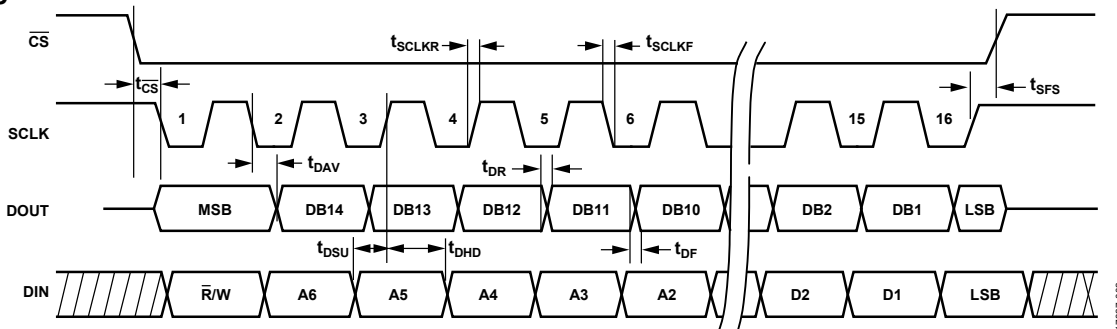

Figure 2. SPI Timing and Sequence Diagram

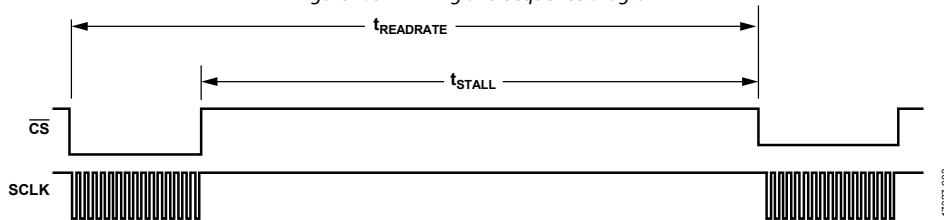

Figure 3. Stall Time and Data Rate Timing Diagram

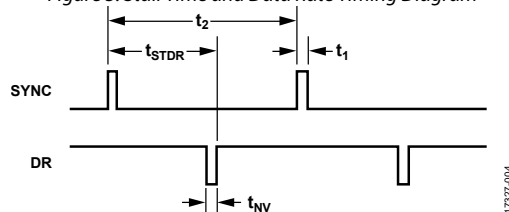

Figure 4. Input Clock Timing Diagram, Direct Sync Mode, Register MSC\_CTRL[3:2] = 01 (Binary)

**ABSOLUTE MAXIMUM RATINGS****Table 3.**

Parameter	Rating
Mechanical Shock Survivability	
Any Axis, Unpowered, 0.5 ms ½ Sine	19,600 m/sec <sup>2</sup>
VDD to GND	–0.3 V to +3.6 V
Digital Input Voltage to GND	–0.3 V to VDD + 0.2 V
Digital Output Voltage to GND	–0.3 V to VDD + 0.2 V
Temperature Range	
Calibration	–10°C to +75°C
Operating	–25°C to +85°C
Storage <sup>1</sup>	–65°C to +150°C
Barometric Pressure	2 bar

<sup>1</sup> Extended exposure to temperatures that are lower than –40°C or higher than +105°C may adversely affect the accuracy of the factory calibration.

Stresses at or above those listed under Absolute Maximum Ratings may cause permanent damage to the product. This is a stress rating only; functional operation of the product at these or any other conditions above those indicated in the operational section of this specification is not implied. Operation beyond the maximum operating conditions for extended periods may affect product reliability.

**THERMAL RESISTANCE**

Thermal performance is directly linked to printed circuit board (PCB) design and operating environment. Careful attention to PCB thermal design is required.

The ADIS16500 is a multichip module that includes many active components. The values in Table 4 identify the thermal response of the hottest component inside of the ADIS16500, with respect to the overall power dissipation of the module. This approach enables a simple method for predicting the temperature of the hottest junction, based on either ambient or case temperature.

For example, when the ambient temperature is 70°C, the hottest junction temperature ( $T_J$ ) inside of the ADIS16500 is 76.7°C.

$$T_J = \theta_{JA} \times VDD \times I_{DD} + 70^\circ\text{C}$$

$$T_J = 107.1^\circ\text{C}/\text{W} \times 3.3 \text{ V} \times 0.044 \text{ A} + 70^\circ\text{C}$$

$$T_J = 85.6^\circ\text{C}$$

**Table 4. Package Characteristics**

Package Type	$\theta_{JA}$ <sup>1</sup>	$\theta_{JC}$ <sup>2</sup>	Device Weight
ML-100-1 <sup>3</sup>	107.1°C/W	74.7°C/W	<1.75 g

<sup>1</sup>  $\theta_{JA}$  is the natural convection junction to ambient thermal resistance measured in a one cubic foot sealed enclosure.

<sup>2</sup>  $\theta_{JC}$  is the junction to case thermal resistance.

<sup>3</sup> Thermal impedance values come from direct observation of the hottest temperature inside of the ADIS16500 when it is attached to an FR4-08 PCB that has two metal layers and has a thickness of 0.063 inches.

**ESD CAUTION****ESD (electrostatic discharge) sensitive device.**

Charged devices and circuit boards can discharge without detection. Although this product features patented or proprietary protection circuitry, damage may occur on devices subjected to high energy ESD. Therefore, proper ESD precautions should be taken to avoid performance degradation or loss of functionality.

### PIN CONFIGURATION AND FUNCTION DESCRIPTIONS

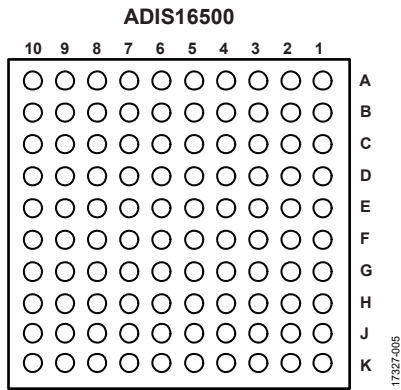

Figure 5. Pin Assignments, Bottom View

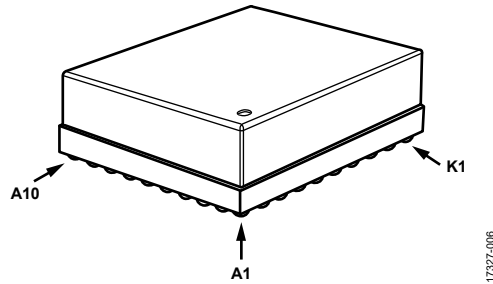

Figure 6. Pin Assignments, Package Level View

Table 5. Pin Function Descriptions

Pin No.	Mnemonic	Type	Description
A1	GND	Supply	Power Ground
A2	GND	Supply	Power Ground
A3	GND	Supply	Power Ground
A4	GND	Supply	Power Ground
A5	GND	Supply	Power Ground
A6	GND	Supply	Power Ground
A7	GND	Supply	Power Ground
A8	GND	Supply	Power Ground
A9	NC	Not applicable	No Connection
A10	NC	Not applicable	No Connection
B1	NC	Not applicable	No Connection
B2	NC	Not applicable	No Connection
B3	GND	Supply	Power Ground
B4	GND	Supply	Power Ground
B5	GND	Supply	Power Ground
B6	GND	Supply	Power Ground
B7	NC	Not applicable	No Connection
B8	NC	Not applicable	No Connection
B9	NC	Not applicable	No Connection
B10	NC	Not applicable	No Connection
C1	NC	Not applicable	No Connection
C2	GND	Supply	Power Ground
C3	DNC	Not applicable	Do Not Connect
C4	NC	Not applicable	No Connection
C5	NC	Not applicable	No Connection
C6	GND	Supply	Power Ground
C7	VDD	Supply	Power Supply
C8	NC	Not applicable	No Connection
C9	NC	Not applicable	No Connection
C10	NC	Not applicable	No Connection



Pin No.	Mnemonic	Type	Description
D1	NC	Not applicable	No Connection
D2	NC	Not applicable	No Connection
D3	GND	Supply	Power Ground
D4	NC	Not applicable	No Connection
D5	NC	Not applicable	No Connection
D6	VDD	Supply	Power Supply
D7	NC	Not applicable	No Connection
D8	NC	Not applicable	No Connection
D9	NC	Not applicable	No Connection
D10	NC	Not applicable	No Connection
E1	NC	Not applicable	No Connection
E2	GND	Supply	Power Ground
E3	VDD	Supply	Power Supply
E4	NC	Not applicable	No Connection
E5	NC	Not applicable	No Connection
E6	GND	Supply	Power Ground
E7	GND	Supply	Power Ground
E8	NC	Not applicable	No Connection
E9	NC	Not applicable	No Connection
E10	NC	Not applicable	No Connection
F1	GND	Supply	Power Ground
F2	NC	Not applicable	No Connection
F3	$\overline{\text{RST}}$	Input	Reset
F4	NC	Not applicable	No Connection
F5	GND	Supply	Power Ground
F6	GND	Supply	Power Ground
F7	NC	Not applicable	No Connection
F8	GND	Supply	Power Ground
F9	NC	Not applicable	No Connection
F10	NC	Not applicable	No Connection
G1	VDD	Supply	Power Supply
G2	GND	Supply	Power Ground
G3	$\overline{\text{CS}}$	Input	SPI, Chip Select
G4	NC	Not applicable	No Connection
G5	NC	Not applicable	No Connection
G6	DIN	Input	SPI, Data Input
G7	GND	Supply	Power Supply
G8	NC	Not applicable	No Connection
G9	NC	Not applicable	No Connection
G10	NC	Not applicable	No Connection
H1	VDD	Supply	Power Supply
H2	NC	Not applicable	No Connection
H3	DOUT	Output	SPI, Data Output
H4	NC	Not applicable	No Connection
H5	NC	Not applicable	No Connection
H6	SCLK	Input	SPI, Serial Clock
H7	NC	Not applicable	No Connection
H8	GND	Supply	Power Ground
H9	NC	Not applicable	No Connection
H10	NC	Not applicable	No Connection

Pin No.	Mnemonic	Type	Description
J1	NC	Not applicable	No Connection
J2	GND	Supply	Power Ground
J3	SYNC	Input	Sync (External Clock)
J4	VDD	Supply	Power Supply
J5	VDD	Supply	Power Supply
J6	DR	Output	Data Ready
J7	GND	Supply	Power Ground
J8	NC	Not applicable	No Connection
J9	NC	Not applicable	No Connection
J10	NC	Not applicable	No Connection
K1	GND	Supply	Power Ground
K2	NC	Not applicable	No Connection
K3	GND	Supply	Power Ground
K4	NC	Not applicable	No Connection
K5	NC	Not applicable	No Connection
K6	VDD	Supply	Power Supply
K7	NC	Not applicable	No Connection
K8	GND	Supply	Power Ground
K9	NC	Not applicable	No Connection
K10	NC	Not applicable	No Connection

# TYPICAL PERFORMANCE CHARACTERISTICS

## GYROSCOPES

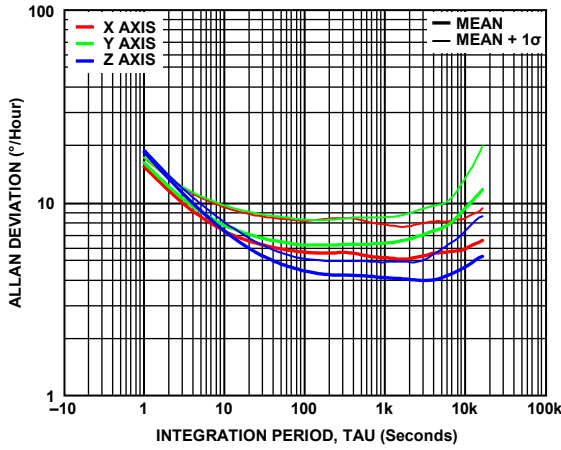

Figure 7. Gyroscope Allan Deviation,  $T_c = 25^\circ\text{C}$ , Plot Taken After 10 Hours of Settling Time

17327-209

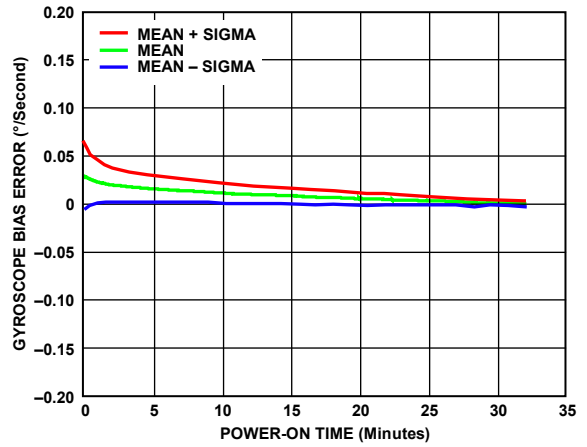

Figure 10. Gyroscope Bias Error vs. Power-On Time,  $T_c = -40^\circ\text{C}$ , All Axes

17327-216

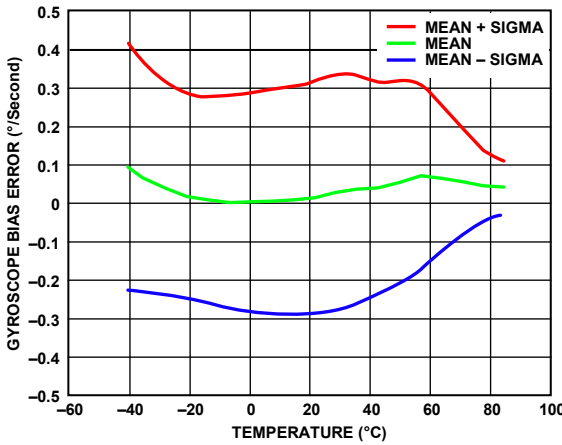

Figure 8. Gyroscope Bias Error vs. Temperature, All Axes

17327-212

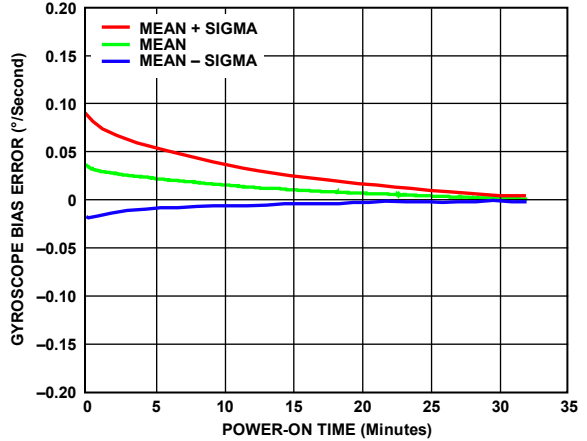

Figure 11. Gyroscope Bias Error vs. Power-On Time,  $T_c = 25^\circ\text{C}$ , All Axes

17327-217

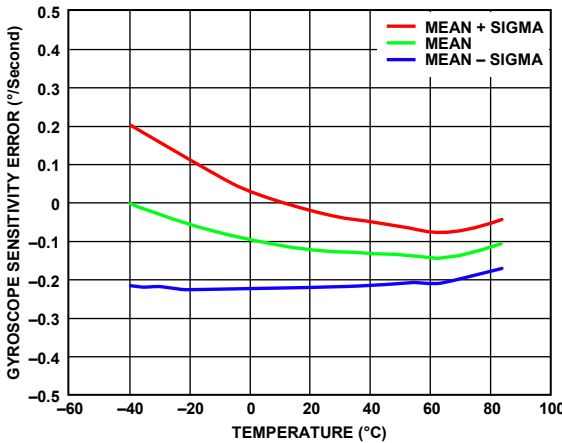

Figure 9. Gyroscope Sensitivity Error vs. Temperature, All Axes

17327-215

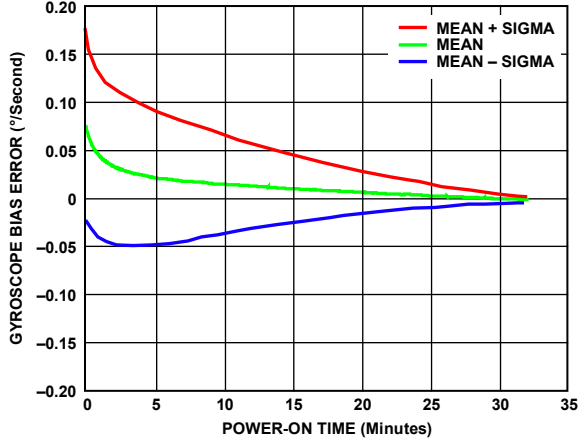

Figure 12. Gyroscope Bias Error vs. Power-On Time,  $T_c = 85^\circ\text{C}$ , All Axes

17327-218

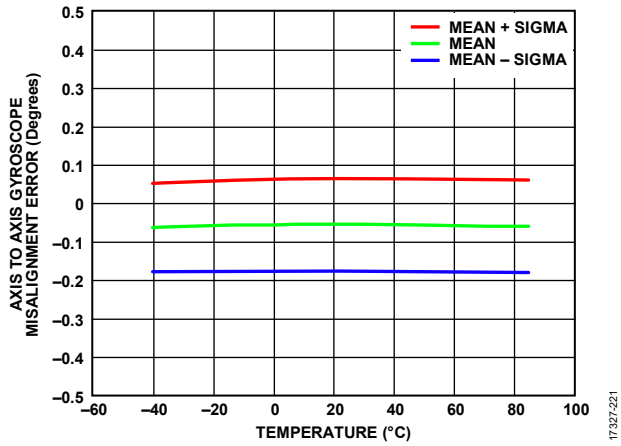

Figure 13. Axis to Axis Gyroscope Misalignment Error vs. Temperature, All Axes

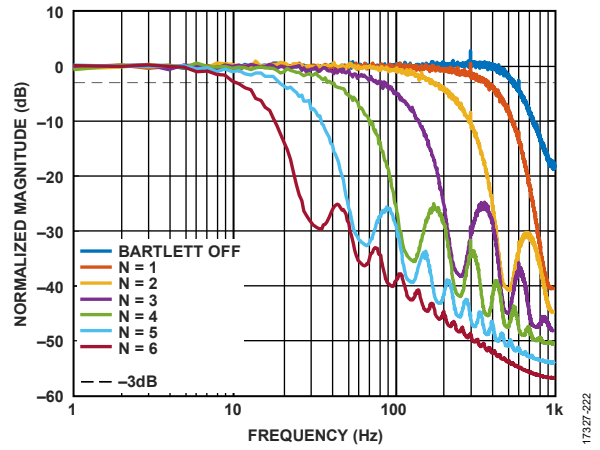

Figure 14. Gyroscope Noise Density, All Axes,  $T_c = 25^\circ\text{C}$

ACCELEROMETERS

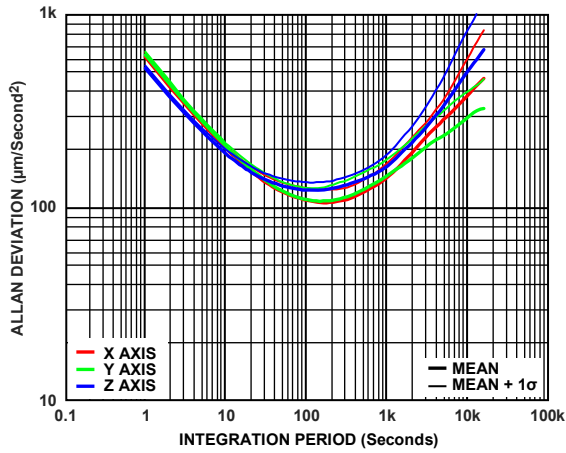

Figure 15. Accelerometer Allan Deviation,  $T_c = 25^\circ\text{C}$

17327-223

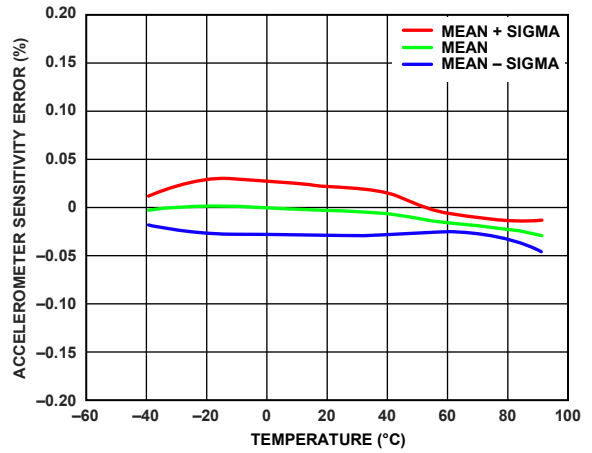

Figure 18. Accelerometer Sensitivity Error vs. Temperature, Cold to Hot, All Axes

17327-226

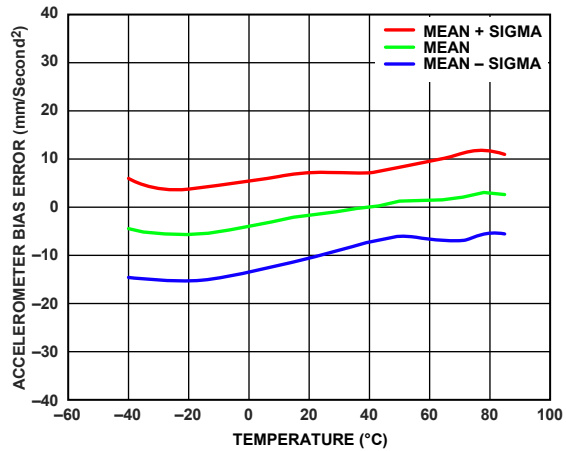

Figure 16. Accelerometer Bias Error vs. Temperature, All Axes, Cold to Hot

17327-224

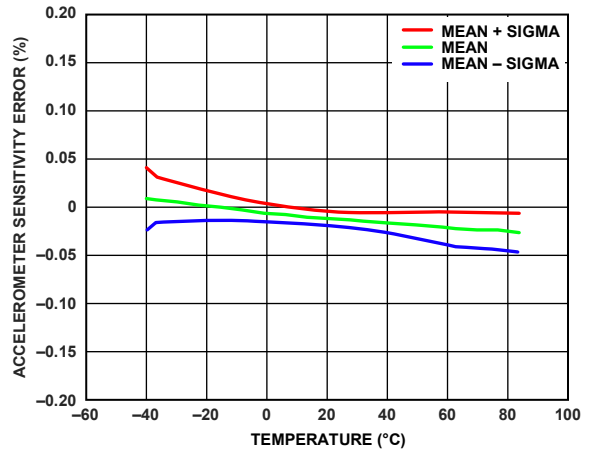

Figure 19. Accelerometer Sensitivity Error vs. Temperature, Hot to Cold, All Axes

17327-227

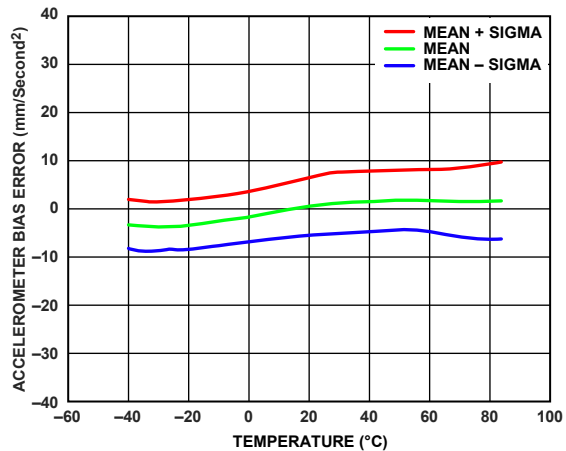

Figure 17. Accelerometer Bias Error vs. Temperature, All Axes, Hot to Cold

17327-225

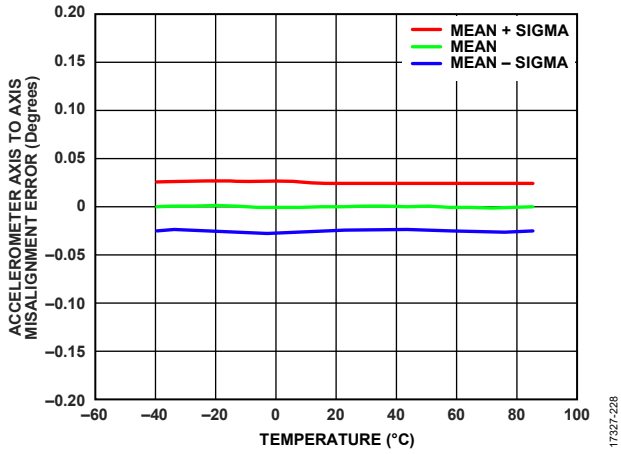

Figure 20. Accelerometer Axis to Axis Misalignment Error vs. Temperature

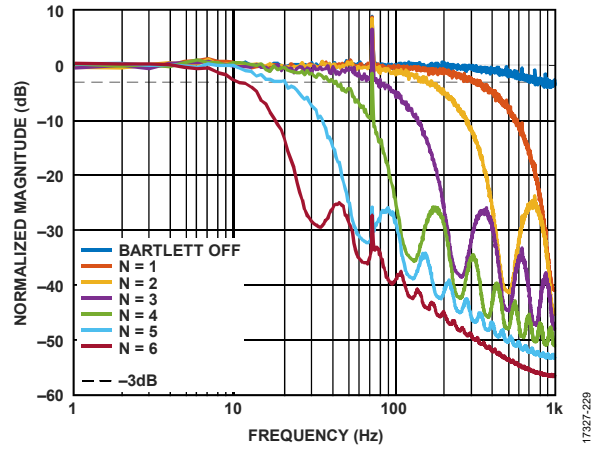

Figure 21. Accelerometer Normalized Noise Density

## THEORY OF OPERATION

### INTRODUCTION

Figure 23 provides the basic signal chain for the accelerometers and gyroscopes of the ADIS16500. When using the factory default configuration, the ADIS16500 initializes itself at power-up and automatically starts a continuous process of sampling, processing, and loading calibrated sensor data into its output registers at a rate of 2000 SPS.

### CLOCK CONTROL

The ADIS16500 provides four modes of operation with respect to the source of the sampling and processing clock (see the frequency sampling clock ( $f_{SM}$ ) in Figure 23): internal, direct input sync, scaled sync, and output sync. The MSC\_CTRL register, Bits[3:2] (see Table 105 and Table 106) provide user selection of these modes.

Note that changes to the MSC\_CTRL[3:2] and UP\_SCALE registers are only updated for readback after the internal clock configuration is complete. Therefore, the user must wait until the DR pin toggles before attempting to verify the desired settings. Changes to MSC\_CTRL[9:6] may take up to 200  $\mu$ s after writing to indicate to the new value during readback. The external clock must also be present for two external clock cycles if either direct input sync mode or scaled sync mode is programmed.

#### Internal Clock Mode

Setting MSC\_CTRL register, Bits[3:2] = 00 selects the internal clock mode and is the default. In this mode, the ADIS16500 uses an internally generated clock that has a nominal frequency of 2000 Hz to drive sampling and data processing for each sensor and associated signal chain.

#### Direct Input Sync Mode

Setting MSC\_CTRL register, Bits[3:2] = 01 selects direct input sync mode and allows  $f_{SM}$  to come directly from an external clock to control the sensor sampling using the SYNC pin as an input. When operating in input sync mode, the ADIS16500 performs best when the external clock frequency ( $f_{SYNC}$ ) is between 1900 Hz and 2100 Hz.

#### Scaled Sync Mode

Setting MSC\_CTRL register, Bits[3:2] = 10 selects scaled sync mode, which supports use of an external sync clock between 1 Hz and 128 Hz that can come from video systems or global positioning systems (GPSs). When operating in scaled sync mode, the frequency of the sample clock is equal to the product of the external clock scale factor,  $K_{ECSF}$  (from the UP\_SCALE register, see Table 107 and Table 108), and the frequency of the clock signal on the SYNC pin. As in input sync mode, the ADIS16500 performs best when  $f_{SM}$  is between 1900 Hz and 2100 Hz.

Changes to the UP\_SCALE register value resets the clock multiplication phase-locked loop (PLL) and restarts the locking process. The locking process starts with an input reference clock edge resetting the feedback clock edge, and lock is declared when time differences between these two edges is  $\leq 100 \mu$ s.

For example, when using a 1 Hz input signal, set UP\_SCALE = 0x07D0 ( $K_{ECSF} = 2000$  (decimal)) to establish a sample rate of 2000 SPS for the inertial sensors and their signal processing. Use the following sequence on the DIN pin to configure UP\_SCALE for this scenario: 0xE2D0, then 0xE307.

#### Output Sync Mode

When Register MSC\_CTRL, Bits[3:2] = 11, the ADIS16500 operates in output sync mode, which is the same as internal clock mode except that the SYNC pin pulses when the internal processor collects data from the inertial sensors. Figure 22 provides an example of this signal.

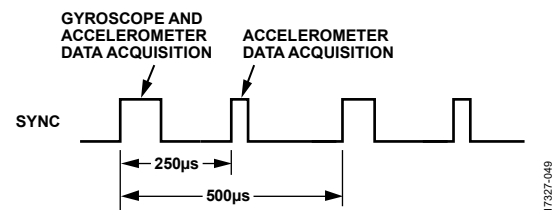

Figure 22. Sync Output Signal, Register MSC\_CTRL, Bits[3:2] = 11

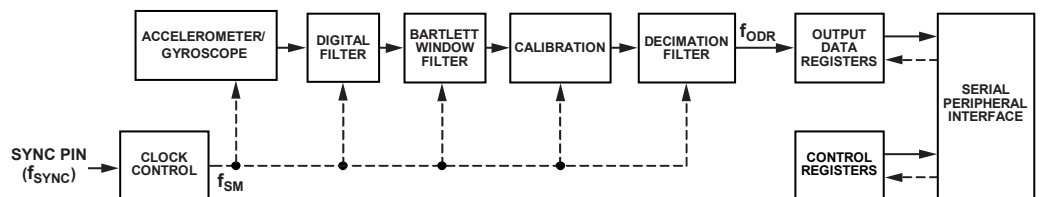

Figure 23. Sensor Signal Chain

**BARTLETT WINDOW FILTER**

The Bartlett window filter is a finite impulse response (FIR) filter (see Figure 24) that contains two averaging filter stages in a cascade configuration. The FILT\_CTRL register (see Table 102) provides the configuration controls for this filter.

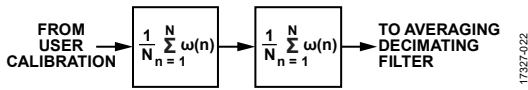

Figure 24. Bartlett Window FIR Filter Signal Path

**CALIBRATION**

The inertial sensor calibration function for the gyroscopes and the accelerometers has two components: factory calibration and user calibration (see Figure 25).

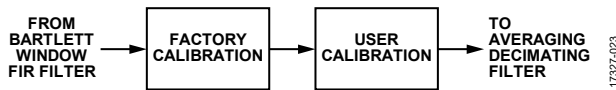

Figure 25. Inertial Sensor Calibration Processing

The factory calibration of the gyroscope applies the following correction formulas to the data of each gyroscope:

$$\begin{bmatrix} \omega_{XC} \\ \omega_{YC} \\ \omega_{ZC} \end{bmatrix} = \begin{bmatrix} m_{11} & m_{12} & m_{13} \\ m_{21} & m_{22} & m_{23} \\ m_{31} & m_{32} & m_{33} \end{bmatrix} \times \begin{bmatrix} \omega_X \\ \omega_Y \\ \omega_Z \end{bmatrix} + \begin{bmatrix} b_X \\ b_Y \\ b_Z \end{bmatrix} + \begin{bmatrix} l_{11} & l_{12} & l_{13} \\ l_{21} & l_{22} & l_{23} \\ l_{31} & l_{32} & l_{33} \end{bmatrix} \times \begin{bmatrix} a_{XC} \\ a_{YC} \\ a_{ZC} \end{bmatrix}$$

where:

- $\omega_{XC}$ ,  $\omega_{YC}$ , and  $\omega_{ZC}$  are the gyroscope outputs (post calibration).
- $m_{11}$ ,  $m_{12}$ ,  $m_{13}$ ,  $m_{21}$ ,  $m_{22}$ ,  $m_{23}$ ,  $m_{31}$ ,  $m_{32}$ , and  $m_{33}$  provide scale and alignment correction.
- $\omega_X$ ,  $\omega_Y$ , and  $\omega_Z$  are the gyroscope outputs (precalibration).
- $b_X$ ,  $b_Y$ , and  $b_Z$  provide bias correction.
- $l_{11}$ ,  $l_{12}$ ,  $l_{13}$ ,  $l_{21}$ ,  $l_{22}$ ,  $l_{23}$ ,  $l_{31}$ ,  $l_{32}$ , and  $l_{33}$  provide linear acceleration correction
- $a_{XC}$ ,  $a_{YC}$ , and  $a_{ZC}$  are the accelerometer outputs (post calibration).

All of the correction factors in this relationship come from direct observation of the response of each gyroscope at multiple temperatures over the calibration temperature range ( $-40^\circ\text{C} \leq T_c \leq +85^\circ\text{C}$ ). These correction factors are stored in the flash memory bank, but they are not available for observation or configuration.

Register MSC\_CTRL, Bit 7 (see Table 106) provides the only user-configurable option for the factory calibration of the gyroscopes: an on/off control for the linear acceleration compensation. See Figure 49 for more details on the user calibration options available for the gyroscopes.

The factory calibration of the accelerometer applies the following correction formulas to the data of each accelerometer:

$$\begin{bmatrix} a_{XC} \\ a_{YC} \\ a_{ZC} \end{bmatrix} = \begin{bmatrix} m_{11} & m_{12} & m_{13} \\ m_{21} & m_{22} & m_{23} \\ m_{31} & m_{32} & m_{33} \end{bmatrix} \times \begin{bmatrix} a_X \\ a_Y \\ a_Z \end{bmatrix} + \begin{bmatrix} b_X \\ b_Y \\ b_Z \end{bmatrix} + \begin{bmatrix} 0 & p_{12} & p_{13} \\ p_{21} & 0 & p_{23} \\ p_{31} & p_{32} & 0 \end{bmatrix} \times \begin{bmatrix} \omega_{XC}^2 \\ \omega_{YC}^2 \\ \omega_{ZC}^2 \end{bmatrix}$$

where:

- $a_{XC}$ ,  $a_{YC}$ , and  $a_{ZC}$  are the accelerometer outputs (post calibration).
- $m_{11}$ ,  $m_{12}$ ,  $m_{13}$ ,  $m_{21}$ ,  $m_{22}$ ,  $m_{23}$ ,  $m_{31}$ ,  $m_{32}$ , and  $m_{33}$  provide scale and alignment correction.
- $a_X$ ,  $a_Y$ , and  $a_Z$  are the accelerometer outputs (precalibration).
- $b_X$ ,  $b_Y$ , and  $b_Z$  provide bias correction.
- $p_{12}$ ,  $p_{13}$ ,  $p_{21}$ ,  $p_{23}$ ,  $p_{31}$  and  $p_{32}$  provide a point of percussion alignment correction (see Figure 52).
- $\omega_{XC}^2$ ,  $\omega_{YC}^2$ , and  $\omega_{ZC}^2$  are the square of the gyroscope outputs (post calibration).

All of the correction factors in this relationship come from direct observation of the response of each accelerometer at multiple temperatures, over the calibration temperature range ( $-40^\circ\text{C} \leq T_c \leq +85^\circ\text{C}$ ). These correction factors are stored in the flash memory bank but are not available for observation or configuration. MSC\_CTRL, Bit 6 (see Table 106) provides the only user configuration option for the factory calibration of the accelerometers: an on/off control for the point of percussion, alignment function. See Figure 50 for more details on the user calibration options available for the accelerometers.

**DECIMATION FILTER**

The second digital filter averages multiple samples together to produce each register update. The number of samples in the average is equal to the reduction in the update rate ( $f_{ODR}$ ) for the output data registers (see Figure 26). The DEC\_RATE register (see Table 110) provides the configuration controls for this filter.

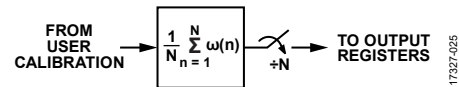

Figure 26. Decimating Filter Diagram

**REGISTER STRUCTURE**

All communication between the ADIS16500 and an external processor involves either reading the contents of an output register or writing configuration/command information to a control register. The output data registers include the latest sensor data, error flags, and identification information. The control registers include sample rate, filtering, calibration, and diagnostic options. Each user accessible register has two bytes (upper and lower), each of which has its own unique address. See Table 9 for a detailed list of all user registers, along with their addresses.



**SPI**

The SPI provides access to the user registers (see Table 9). Figure 27 shows the most common connections between the ADIS16500 and a SPI master device, which is often an embedded processor that has a SPI-compatible interface. In this example, the SPI master uses an interrupt service routine to collect data every time the data ready (DR) signal pulses.

Additional information on the SPI can be found in the Applications Information section.

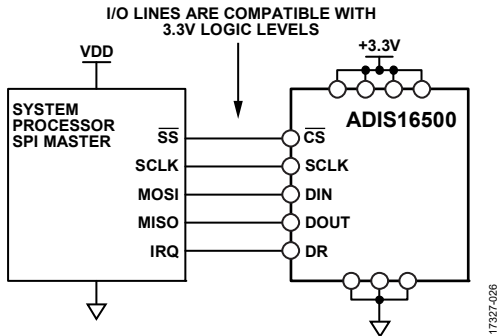

Figure 27. Electrical Connection Diagram

Table 6 provides an example list of pin names for the SPI port in an embedded processor.

**Table 6. Generic SPI Master Pin Names and Functions**

Mnemonic	Function
SS	Slave select
SCLK	Serial clock
MOSI	Master output, slave input
MISO	Master input, slave output
IRQ	Interrupt request

Embedded processors typically configure their serial ports for communicating with SPI slave devices such as the ADIS16500 by using control registers on the processor itself. Table 7 lists the SPI protocol settings for the ADIS16500.

**Table 7. Generic Master Processor SPI Settings**

Processor Setting	Description
Master	ADIS16500 operates as slave
$SCLK \leq 2 \text{ MHz}^1$	Maximum serial clock rate
SPI Mode 3	CPOL = 1 (polarity), CPHA = 1 (phase)
MSB First Mode	Bit sequence, see Figure 33 for coding
16-Bit Mode	Shift register and data length

<sup>1</sup> A burst mode read requires this value to be  $\leq 1 \text{ MHz}$  (see Table 2 for more information).

**DATA READY (DR)**

The factory default configuration provides users with a DR signal on the DR pin (see Table 5), which pulses when the output data registers are updating. Connect the DR pin to an input pin on the embedded processor and configure this pin to trigger data collection on the second edge of the pulse on the DR pin. The MSC\_CTRL register, Bit 0 (see Table 106), controls the polarity of this signal. In Figure 28 shows a DR signal with Register MSC\_CTRL, Bit 0 = 1, meaning that data collection must start on the rising edges of the DR pulses.



Figure 28. Data Ready When Register MSC\_CTRL, Bit 0 = 1 (Default)

During the start-up and reset recovery processes, the DR signal can exhibit some transient behavior before data production begins. Figure 29 shows an example of the DR behavior during startup, and Figure 30 and Figure 31 provide examples of the DR behavior during recovery from reset commands.

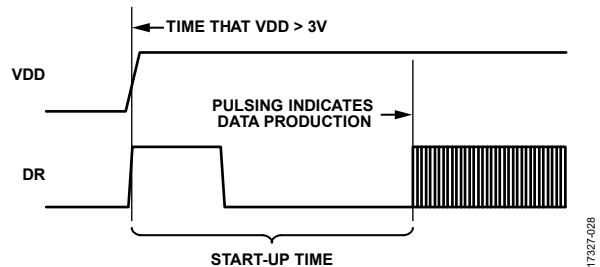

Figure 29. Data Ready Response During Startup

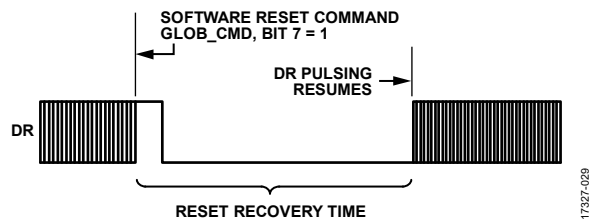

Figure 30. Data Ready Response During Reset Recovery (Register GLOB\_CMD, Bit 7 = 1)

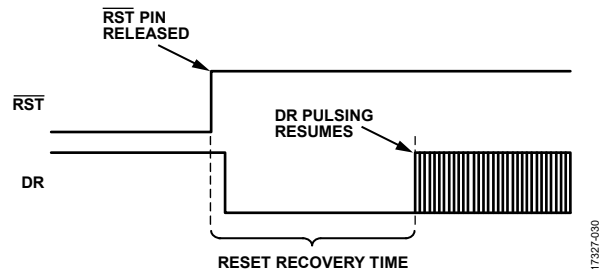

Figure 31. Data Ready Response During Reset ( $\overline{RST} = 0$ ) Recovery

**READING SENSOR DATA**

Reading a single register requires two 16-bit cycles on the SPI: one to request the contents of a register and another to receive those contents. The 16-bit command code (see Figure 33) for a read request on the SPI has three parts: the read bit ( $\bar{R}/W = 0$ ), either address of the register, [A6:A0], and eight don't care bits, [DC7:DC0]. Figure 32 shows an example that includes two register reads in succession. This example starts with DIN = 0x0C00 to request the contents of the Z\_GYRO\_LOW register, and follows with 0x0E00 to request the contents of the Z\_GYRO\_OUT register. The sequence in Figure 32 also shows full duplex mode of operation, which means that the ADIS16500 can receive

requests on DIN while also transmitting data out on DOUT within the same 16-bit SPI cycle.



Figure 32. SPI Read Example

Figure 34 provides an example of the four SPI signals when reading the PROD\_ID register (see Table 120) in a repeating pattern. This pattern can be helpful when troubleshooting the SPI interface setup and communications because the signals are the same for each 16-bit sequence, except during the first cycle.

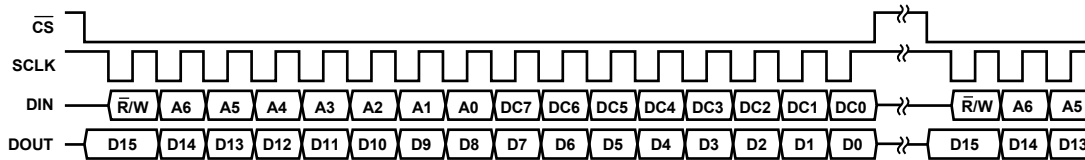

**NOTES**

1. DOUT BITS ARE PRODUCED ONLY WHEN THE PREVIOUS 16-BIT DIN SEQUENCE STARTS WITH  $\bar{R}/W = 0$ .
2. WHEN  $\bar{CS}$  IS HIGH, DOUT IS IN A THREE-STATE, HIGH IMPEDANCE MODE, WHICH ALLOWS MULTIFUNCTIONAL USE OF THE LINE FOR OTHER DEVICES.

Figure 33. SPI Communication Bit Sequence

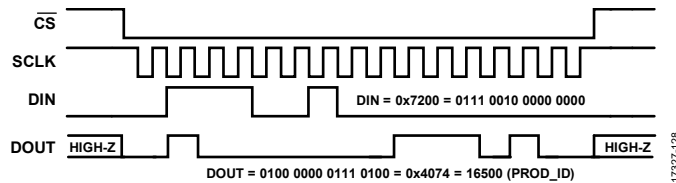

Figure 34. SPI Signal Pattern, Repeating Read of the PROD\_ID Register

## BURST READ FUNCTION

The burst read function provides a way to read a batch of output data registers, using a continuous stream of bits, at a rate of up to 1 MHz (SCLK). This method does not require a stall time between each 16-bit segment (see Figure 3). As shown in Figure 35, start this mode by setting  $DIN = 0x6800$ , and then read each of the registers in the sequence out of DOUT while keeping  $\overline{CS}$  low for the entire data transfer sequence.

The three options for burst mode include: scaled sync mode on or off, BURST32 enabled and disabled, and  $BURST\_SEL = 0$  or  $BURSET\_SEL = 1$ . This results in eight possible burst data formats.

### Scaled Sync Mode Enabled vs. Disabled

The only differences in the burst data format between these two modes are the final two bytes in a burst. In scaled sync mode, the final two bytes are the values of the TIME\_STAMP registers. When scaled sync mode is disabled, the final two bytes are the values in the DATA\_CNTR registers. As always, Bits[15:8] appear before Bits[7:0] in both modes.

For the rest of this section, it is assumed that scaled sync mode is disabled.

### 16-Bit Burst Mode with $BURST\_SEL = 0$

In 16-bit burst mode with  $BURST\_SEL = 0$ , a burst contains calibrated gyroscope and accelerometer data in 16-bit format. This mode is particularly appropriate for cases where there is no decimation nor filtering. Not only is the sample rate high (~2 kSPS), the lower 16 bits are not used unless the user is averaging or filtering.

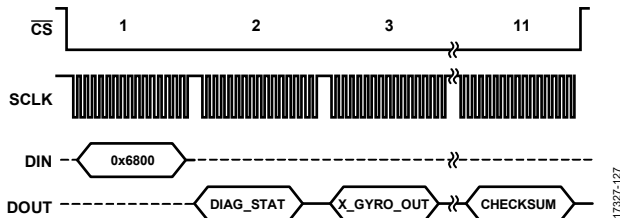

Figure 35. Burst Read Sequence with  $BURST\_SEL = 0$

The sequence of registers (and checksum value) in the burst read includes the following registers and value: DIAG\_STAT, X\_GYRO\_OUT, Y\_GYRO\_OUT, Z\_GYRO\_OUT, X\_ACCL\_OUT, Y\_ACCL\_OUT, Z\_ACCL\_OUT, TEMP\_OUT, DATA\_CNTR, and the checksum value.

In these cases, use the following formula to verify the 16-bit checksum value, treating each byte in the formula as an independent, unsigned, 8-bit number:

$$\begin{aligned} \text{Checksum} = & \text{DIAG\_STAT, Bits}[15:8] + \text{DIAG\_STAT, Bits}[7:0] + \\ & \text{X\_GYRO\_OUT, Bits}[15:8] + \text{X\_GYRO\_OUT, Bits}[7:0] + \\ & \text{Y\_GYRO\_OUT, Bits}[15:8] + \text{Y\_GYRO\_OUT, Bits}[7:0] + \\ & \text{Z\_GYRO\_OUT, Bits}[15:8] + \text{Z\_GYRO\_OUT, Bits}[7:0] + \\ & \text{X\_ACCL\_OUT, Bits}[15:8] + \text{X\_ACCL\_OUT, Bits}[7:0] + \\ & \text{Y\_ACCL\_OUT, Bits}[15:8] + \text{Y\_ACCL\_OUT, Bits}[7:0] + \\ & \text{Z\_ACCL\_OUT, Bits}[15:8] + \text{Z\_ACCL\_OUT, Bits}[7:0] + \\ & \text{TEMP\_OUT, Bits}[15:8] + \text{TEMP\_OUT, Bits}[7:0] + \\ & \text{DATA\_CNTR, Bits}[15:8] + \text{DATA\_CNTR, Bits}[7:0] \end{aligned}$$

### 16-Bit Burst Mode with $BURST\_SEL = 1$

In 16-bit burst mode with  $BURST\_SEL = 1$ , a burst contains calibrated delta angle and delta velocity data in 16-bit format. This mode is particularly appropriate for cases where there is no decimation nor filtering. Not only is the sample rate high (~2 kSPS), the lower 16 bits are not used.

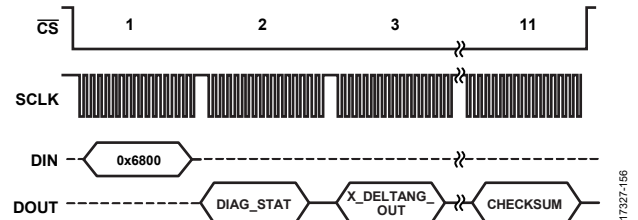

Figure 36. Burst Read Sequence with  $BURST\_SEL = 1$

The sequence of registers (and checksum value) in the burst read includes the following registers and value: DIAG\_STAT, X\_DELTANG\_OUT, Y\_DELTANG\_OUT, Z\_DELTANG\_OUT, X\_DELTVEL\_OUT, Y\_DELTVEL\_OUT, Z\_DELTVEL\_OUT, TEMP\_OUT, DATA\_CNTR, and the checksum value.

In these cases, use the following formula to verify the 16-bit checksum value, treating each byte in the formula as an independent, unsigned, 8-bit number:

$$\begin{aligned} \text{Checksum} = & \text{DIAG\_STAT, Bits}[15:8] + \text{DIAG\_STAT, Bits}[7:0] + \\ & \text{X\_DELTANG\_OUT, Bits}[15:8] + \text{X\_DELTANG\_OUT, Bits}[7:0] + \\ & \text{Y\_DELTANG\_OUT, Bits}[15:8] + \text{Y\_DELTANG\_OUT, Bits}[7:0] + \\ & \text{Z\_DELTANG\_OUT, Bits}[15:8] + \text{Z\_DELTANG\_OUT, Bits}[7:0] + \\ & \text{X\_DELTVEL\_OUT, Bits}[15:8] + \text{X\_DELTVEL\_OUT, Bits}[7:0] + \\ & \text{Y\_DELTVEL\_OUT, Bits}[15:8] + \text{Y\_DELTVEL\_OUT, Bits}[7:0] + \\ & \text{Z\_DELTVEL\_OUT, Bits}[15:8] + \text{Z\_DELTVEL\_OUT, Bits}[7:0] + \\ & \text{TEMP\_OUT, Bits}[15:8] + \text{TEMP\_OUT, Bits}[7:0] + \\ & \text{DATA\_CNTR, Bits}[15:8] + \text{DATA\_CNTR, Bits}[7:0] \end{aligned}$$

**32-Bit Burst Mode with BURST\_SEL = 0**

In 32-bit burst mode with BURST\_SEL = 0, a burst contains calibrated gyroscope and accelerometer data in 32-bit format. This mode is appropriate for cases where there is averaging (decimation) and/or low-pass filtering of the data.

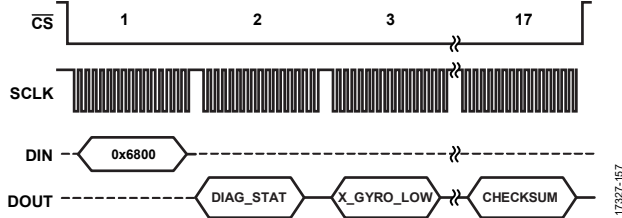

Figure 37. Burst Read Sequence with BURST\_SEL = 0

The sequence of registers (and checksum value) in the burst read includes the following registers and value: DIAG\_STAT, X\_GYRO\_LOW, X\_GYRO\_OUT, Y\_GYRO\_LOW, Y\_GYRO\_OUT, Z\_GYRO\_LOW, Z\_GYRO\_OUT, X\_ACCL\_LOW, X\_ACCL\_OUT, Y\_ACCL\_LOW, Y\_ACCL\_OUT, Z\_ACCL\_LOW, Z\_ACCL\_OUT, TEMP\_OUT, DATA\_CNTR, and the checksum value. In these cases, use the following formula to verify the 16-bit checksum value, treating each byte in the formula as an independent, unsigned, 8-bit number:

$$\begin{aligned} \text{Checksum} = & \text{DIAG\_STAT, Bits}[15:8] + \text{DIAG\_STAT, Bits}[7:0] + \\ & \text{X\_GYRO\_LOW, Bits}[15:8] + \text{X\_GYRO\_LOW, Bits}[7:0] + \\ & \text{X\_GYRO\_OUT, Bits}[15:8] + \text{X\_GYRO\_OUT, Bits}[7:0] + \\ & \text{Y\_GYRO\_LOW, Bits}[15:8] + \text{Y\_GYRO\_LOW, Bits}[7:0] + \\ & \text{Y\_GYRO\_OUT, Bits}[15:8] + \text{Y\_GYRO\_OUT, Bits}[7:0] + \\ & \text{Z\_GYRO\_LOW, Bits}[15:8] + \text{Z\_GYRO\_LOW, Bits}[7:0] + \\ & \text{Z\_GYRO\_OUT, Bits}[15:8] + \text{Z\_GYRO\_OUT, Bits}[7:0] + \\ & \text{X\_ACCL\_LOW, Bits}[15:8] + \text{X\_ACCL\_LOW, Bits}[7:0] + \\ & \text{X\_ACCL\_OUT, Bits}[15:8] + \text{X\_ACCL\_OUT, Bits}[7:0] + \\ & \text{Y\_ACCL\_LOW, Bits}[15:8] + \text{Y\_ACCL\_LOW, Bits}[7:0] + \\ & \text{Y\_ACCL\_OUT, Bits}[15:8] + \text{Y\_ACCL\_OUT, Bits}[7:0] + \\ & \text{Z\_ACCL\_LOW, Bits}[15:8] + \text{Z\_ACCL\_LOW, Bits}[7:0] + \\ & \text{Z\_ACCL\_OUT, Bits}[15:8] + \text{Z\_ACCL\_OUT, Bits}[7:0] + \\ & \text{TEMP\_OUT, Bits}[15:8] + \text{TEMP\_OUT, Bits}[7:0] + \\ & \text{DATA\_CNTR, Bits}[15:8] + \text{DATA\_CNTR, Bits}[7:0] \end{aligned}$$

**32-Bit Burst Mode with BURST\_SEL = 1**

In 32-bit burst mode with BURST\_SEL = 1, a burst contains calibrated delta angle and delta velocity data in 32-bit format. This mode is appropriate for cases where there is averaging (decimation) and/or low-pass filtering of the data.

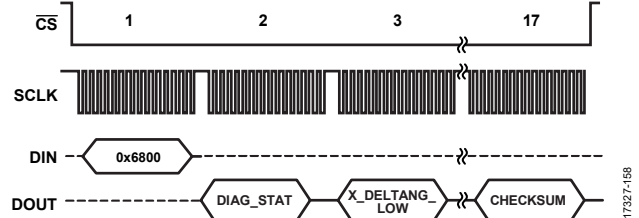

Figure 38. Burst Read Sequence with BURST\_SEL = 1

The sequence of registers (and checksum value) in the burst read includes the following registers and value: DIAG\_STAT, X\_DELTANG\_LOW, X\_DELTANG\_OUT, Y\_DELTANG\_LOW, Y\_DELTANG\_OUT, Z\_DELTANG\_LOW, Z\_DELTANG\_OUT, X\_DELTVEL\_LOW, X\_DELTVEL\_OUT, Y\_DELTVEL\_LOW, Y\_DELTVEL\_OUT, Z\_DELTVEL\_LOW, Z\_DELTVEL\_OUT, TEMP\_OUT, DATA\_CNTR, and the checksum value. In these cases, use the following formula to verify the 16-bit checksum value, treating each byte in the formula as an independent, unsigned, 8-bit number:

$$\begin{aligned} \text{Checksum} = & \text{DIAG\_STAT, Bits}[15:8] + \text{DIAG\_STAT, Bits}[7:0] + \\ & \text{X\_DELTANG\_LOW, Bits}[15:8] + \text{X\_DELTANG\_LOW, Bits}[7:0] + \\ & \text{X\_DELTANG\_OUT, Bits}[15:8] + \text{X\_DELTANG\_OUT, Bits}[7:0] + \\ & \text{Y\_DELTANG\_LOW, Bits}[15:8] + \text{Y\_DELTANG\_LOW, Bits}[7:0] + \\ & \text{Y\_DELTANG\_OUT, Bits}[15:8] + \text{Y\_DELTANG\_OUT, Bits}[7:0] + \\ & \text{Z\_DELTANG\_LOW, Bits}[15:8] + \text{Z\_DELTANG\_LOW, Bits}[7:0] + \\ & \text{Z\_DELTANG\_OUT, Bits}[15:8] + \text{Z\_DELTANG\_OUT, Bits}[7:0] + \\ & \text{X\_DELTVEL\_LOW, Bits}[15:8] + \text{X\_DELTVEL\_LOW, Bits}[7:0] + \\ & \text{X\_DELTVEL\_OUT, Bits}[15:8] + \text{X\_DELTVEL\_OUT, Bits}[7:0] + \\ & \text{Y\_DELTVEL\_LOW, Bits}[15:8] + \text{Y\_DELTVEL\_LOW, Bits}[7:0] + \\ & \text{Y\_DELTVEL\_OUT, Bits}[15:8] + \text{Y\_DELTVEL\_OUT, Bits}[7:0] + \\ & \text{Z\_DELTVEL\_LOW, Bits}[15:8] + \text{Z\_DELTVEL\_LOW, Bits}[7:0] + \\ & \text{Z\_DELTVEL\_OUT, Bits}[15:8] + \text{Z\_DELTVEL\_OUT, Bits}[7:0] + \\ & \text{TEMP\_OUT, Bits}[15:8] + \text{TEMP\_OUT, Bits}[7:0] + \\ & \text{DATA\_CNTR, Bits}[15:8] + \text{DATA\_CNTR, Bits}[7:0] \end{aligned}$$

**LATENCY**

Table 8 contains the group delay for each inertial sensor when the ADIS16500 is operating with the factory default settings for the FILT\_CTRL (see Table 101) and DEC\_RATE (see Table 109) registers.

**Table 8. Group Delay with No Filtering**

Inertial Sensor	Group Delay (ms) <sup>1</sup>
Accelerometer	1.57
Gyroscope (X-Axis)	1.51
Gyroscope (Y-Axis)	1.51
Gyroscope (Z-Axis)	1.29

<sup>1</sup> In this context, latency represents the time between the motion (linear acceleration and/or angular rate of rotation) and the time that the representative data is available in the output data register.

When the FILT\_CTRL register is not equal to 0, the group delay contribution of the Bartlett window filter (in terms of sample cycles) is equal to N (see Table 102). When the DEC\_RATE register is not equal to 0, the group delay contribution of the decimation filter (in terms of sample cycles) is equal D + 1, divided by 2 (see Table 110).

**Data Acquisition**

The total latency is equal to the sum of the group delay and the data acquisition time, which represents the time it takes the system processor to read the data from the output data registers of the ADIS16500. For example, when using the burst read function, with an SCLK rate of 1 MHz, the data acquisition time is equal to 176 μs (11 segments × 16 SCLKs/segment × 1 μs/SCLK).

**DEVICE CONFIGURATION**

Each configuration register contains 16 bits (two bytes). Bits[7:0] contain the low byte, and Bits[15:8] contain the high byte. Each byte has its own unique address in the user register map (see Table 9). Updating the contents of a register requires writing to both of its bytes in the following sequence: low byte first, high byte second. There are three parts to coding a SPI command (see Figure 33) that write a new byte of data to a register: the write bit ( $\bar{R}/W = 1$ ), the address of the byte, [A6:A0], and the new

data for that location, [DC7:DC0]. Figure 39 shows a coding example for writing 0x0004 to the FILT\_CTRL register (see Table 102). In Figure 39, the 0xDC04 command writes 0x04 to Address 0x5C (lower byte) and the 0xDD00 command writes 0x00 to Address 0x5D (upper byte).

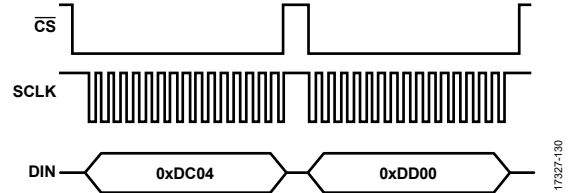

Figure 39. SPI Sequence for Writing 0x0004 to FILT\_CTRL

**MEMORY STRUCTURE**

Figure 40 provides a functional diagram for the memory structure of the ADIS16500. The flash memory bank contains the operational code, unit specific calibration coefficients, and user configuration settings. During initialization (power application or reset recover), this information loads from the flash memory into the static random access memory (SRAM), which supports all normal operation including register access through the SPI port. Writing to a configuration register using the SPI updates the SRAM location of the register but does not automatically update its settings in the flash memory bank. The manual flash memory update command (Register GLOB\_CMD, Bit 3, see Table 112) provides a convenient method for saving all of these settings to the flash memory bank at one time. A yes in the flash backup column of Table 9 identifies the registers that have storage support in the flash memory bank.

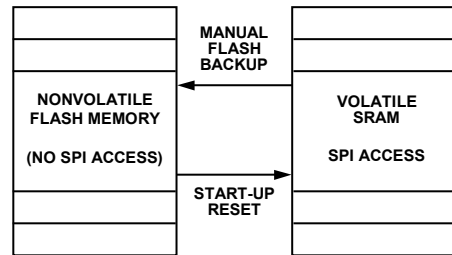

Figure 40. SRAM and Flash Memory Diagram

## USER REGISTER MEMORY MAP

Table 9. User Register Memory Map (N/A Means Not Applicable)

Name	R/W	Flash Backup	Address	Default	Register Description
Reserved	N/A	N/A	0x00, 0x01	N/A	Reserved
DIAG_STAT	R	No	0x02, 0x03	0x0000	Output, system error flags
X_GYRO_LOW	R	No	0x04, 0x05	N/A	Output, x-axis gyroscope, low word
X_GYRO_OUT	R	No	0x06, 0x07	N/A	Output, x-axis gyroscope, high word
Y_GYRO_LOW	R	No	0x08, 0x09	N/A	Output, y-axis gyroscope, low word
Y_GYRO_OUT	R	No	0x0A, 0x0B	N/A	Output, y-axis gyroscope, high word
Z_GYRO_LOW	R	No	0x0C, 0x0D	N/A	Output, z-axis gyroscope, low word
Z_GYRO_OUT	R	No	0x0E, 0x0F	N/A	Output, z-axis gyroscope, high word
X_ACCL_LOW	R	No	0x10, 0x11	N/A	Output, x-axis accelerometer, low word
X_ACCL_OUT	R	No	0x12, 0x13	N/A	Output, x-axis accelerometer, high word
Y_ACCL_LOW	R	No	0x14, 0x15	N/A	Output, y-axis accelerometer, low word
Y_ACCL_OUT	R	No	0x16, 0x17	N/A	Output, y-axis accelerometer, high word
Z_ACCL_LOW	R	No	0x18, 0x19	N/A	Output, z-axis accelerometer, low word
Z_ACCL_OUT	R	No	0x1A, 0x1B	N/A	Output, z-axis accelerometer, high word
TEMP_OUT	R	No	0x1C, 0x1D	N/A	Output, temperature
TIME_STAMP	R	No	0x1E, 0x1F	N/A	Output, time stamp
Reserved	N/A	N/A	0x20, 0x21	N/A	Reserved
DATA_CNTR	R	No	0x22, 0x23	N/A	New data counter
X_DELTANG_LOW	R	No	0x24, 0x25	N/A	Output, x-axis delta angle, low word
X_DELTANG_OUT	R	No	0x26, 0x27	N/A	Output, x-axis delta angle, high word
Y_DELTANG_LOW	R	No	0x28, 0x29	N/A	Output, y-axis delta angle, low word
Y_DELTANG_OUT	R	No	0x2A, 0x2B	N/A	Output, y-axis delta angle, high word
Z_DELTANG_LOW	R	No	0x2C, 0x2D	N/A	Output, z-axis delta angle, low word
Z_DELTANG_OUT	R	No	0x2E, 0x2F	N/A	Output, z-axis delta angle, high word
X_DELTVEL_LOW	R	No	0x30, 0x31	N/A	Output, x-axis delta velocity, low word
X_DELTVEL_OUT	R	No	0x32, 0x33	N/A	Output, x-axis delta velocity, high word
Y_DELTVEL_LOW	R	No	0x34, 0x35	N/A	Output, y-axis delta velocity, low word
Y_DELTVEL_OUT	R	No	0x36, 0x37	N/A	Output, y-axis delta velocity, high word
Z_DELTVEL_LOW	R	No	0x38, 0x39	N/A	Output, z-axis delta velocity, low word
Z_DELTVEL_OUT	R	No	0x3A, 0x3B	N/A	Output, z-axis delta velocity, high word
Reserved	N/A	N/A	0x3C to 0x3F	N/A	Reserved
XG_BIAS_LOW	R/W	Yes	0x40, 0x41	0x0000	Calibration, offset, gyroscope, x-axis, low word
XG_BIAS_HIGH	R/W	Yes	0x42, 0x43	0x0000	Calibration, offset, gyroscope, x-axis, high word
YG_BIAS_LOW	R/W	Yes	0x44, 0x45	0x0000	Calibration, offset, gyroscope, y-axis, low word
YG_BIAS_HIGH	R/W	Yes	0x46, 0x47	0x0000	Calibration, offset, gyroscope, y-axis, high word
ZG_BIAS_LOW	R/W	Yes	0x48, 0x49	0x0000	Calibration, offset, gyroscope, z-axis, low word
ZG_BIAS_HIGH	R/W	Yes	0x4A, 0x4B	0x0000	Calibration, offset, gyroscope, z-axis, high word
XA_BIAS_LOW	R/W	Yes	0x4C, 0x4D	0x0000	Calibration, offset, accelerometer, x-axis, low word
XA_BIAS_HIGH	R/W	Yes	0x4E, 0x4F	0x0000	Calibration, offset, accelerometer, x-axis, high word
YA_BIAS_LOW	R/W	Yes	0x50, 0x51	0x0000	Calibration, offset, accelerometer, y-axis, low word
YA_BIAS_HIGH	R/W	Yes	0x52, 0x53	0x0000	Calibration, offset, accelerometer, y-axis, high word
ZA_BIAS_LOW	R/W	Yes	0x54, 0x55	0x0000	Calibration, offset, accelerometer, z-axis, low word
ZA_BIAS_HIGH	R/W	Yes	0x56, 0x57	0x0000	Calibration, offset, accelerometer, z-axis, high word
Reserved	N/A	N/A	0x58 to 0x5B	N/A	Reserved
FILT_CTRL	R/W	Yes	0x5C, 0x5D	0x0000	Control, Bartlett window FIR filter
RANG_MDL	R	No	0x5E, 0x5F	N/A <sup>1</sup>	Measurement range (model specific) identifier

Name	R/W	Flash Backup	Address	Default	Register Description
MSC_CTRL	R/W	Yes	0x60, 0x61	0x00C1	Control, input/output and other miscellaneous options
UP_SCALE	R/W	Yes	0x62, 0x63	0x07D0	Control, scale factor for input clock, scaled sync mode
DEC_RATE	R/W	Yes	0x64, 0x65	0x0000	Control, decimation filter (output data rate)
Reserved	N/A	N/A	0x66, 0x67	N/A	Reserved
GLOB_CMD	W	No	0x68, 0x69	N/A	Control, global commands
Reserved	N/A	N/A	0x6A to 0x6B	N/A	Reserved
FIRM_REV	R	Yes	0x6C, 0x6D	N/A	Identification, firmware revision
FIRM_DM	R	Yes	0x6E, 0x6F	N/A	Identification, date code, day and month
FIRM_Y	R	Yes	0x70, 0x71	N/A	Identification, date code, year
PROD_ID	R	Yes	0x72, 0x73	0x4074	Identification, device number (0x4074 = 16,500 decimal)
SERIAL_NUM	R	Yes	0x74, 0x75	N/A	Identification, serial number
USER_SCR_1	R/W	Yes	0x76, 0x77	N/A	User Scratch Register 1
USER_SCR_2	R/W	Yes	0x78, 0x79	N/A	User Scratch Register 2
USER_SCR_3	R/W	Yes	0x7A, 0x7B	N/A	User Scratch Register 3
FLSHCNT_LOW	R	Yes	0x7C, 0x7D	N/A	Output, flash memory write cycle counter, lower word
FLSHCNT_HIGH	R	Yes	0x7E, 0x7E	N/A	Output, flash memory write cycle counter, upper word

<sup>1</sup> See Table 103 for the model specific default value for this register.

## USER REGISTER DEFINITIONS

### Status/Error Flag Indicators (DIAG\_STAT)

Table 10. DIAG\_STAT Register Definition

Addresses	Default	Access	Flash Backup
0x02, 0x03	0x0000	R	No

Table 11. DIAG\_STAT Bit Assignments

Bits	Description
[15:11]	Reserved.
10	Accelerometer failure. A 1 indicates failure of the accelerometer at the conclusion of the self test (Register GLOB_CMD, Bit 2, see Table 112). If this error occurs, repeat the same test. If this error persists, replace the ADIS16500. Motion during this test may cause a false failure.
9	Gyroscope 2 failure. A 1 indicates failure of Gyroscope 2 at the conclusion of the self test (Register GLOB_CMD, Bit 2, see Table 112). If this error occurs, repeat the same test. If this error persists, replace the ADIS16500. Motion during this test may cause a false failure.
8	Gyroscope 1 failure. A 1 indicates failure of Gyroscope 1 at the conclusion of the self test (Register GLOB_CMD, Bit 2, see Table 112). If this error occurs, repeat the same test. If this error persists, replace the ADIS16500. Motion during this test may cause a false failure.
7	Clock error. A 1 indicates that the internal data sampling clock ( $f_{SM}$ , see Figure 23) does not synchronize with the external clock, which only applies when using scaled sync mode (Register MSC_CTRL, Bits[3:2] = 10, see Table 106). When this error occurs, adjust the frequency of the clock signal on the SYNC pin to operate within the appropriate range.
6	Memory failure. A 1 indicates a failure in the flash memory test (Register GLOB_CMD, Bit 4, see Table 112), which involves a comparison between a cyclic redundancy check (CRC) calculation of the present flash memory and a CRC calculation from the same memory locations at the time of initial programming (during the production process). If this error occurs, repeat the same test. If this error persists, replace the ADIS16500.
5	Sensor failure. This bit is a logical OR of Bit 10, Bit 9, and Bit 8 of this register. A 1 indicates failure of at least one sensor at the conclusion of the self test (Register GLOB_CMD, Bit 2, see Table 112). If this error occurs, repeat the same test. If this error persists, replace the ADIS16500. Motion during the execution of this test may cause a false failure.
4	Standby mode. A 1 indicates that the voltage across VDD and GND is <2.8 V, which causes data processing to stop. When VDD ≥ 2.8 V for 250 ms, the ADIS16500 reinitializes itself and starts producing data again.
3	SPI communication error. A 1 indicates that the total number of SCLK cycles is not equal to an integer multiple of 16. When this error occurs, repeat the previous communication sequence. Persistence in this error may indicate that the SPI connection between the host and the ADIS16500 is not robust (for example, marginal voltage levels, timing, or signal integrity).

Bits	Description
2	Flash memory update failure. A 1 indicates that the most recent flash memory update (Register GLOB_CMD, Bit 3, see Table 112) failed. If this error occurs, ensure that VDD ≥ 3 V and repeat the update attempt. If this error persists, replace the ADIS16500.
1	Data path overrun. A 1 indicates that one of the data paths experienced an overrun condition. If this error occurs, initiate a reset using the $\overline{RST}$ pin (see Table 5, Pin F3) or Register GLOB_CMD, Bit 7 (see Table 112).
0	Reserved.

The DIAG\_STAT register (see Table 10 and Table 11) provides error flags for monitoring the integrity and operation of the ADIS16500. Reading this register resets its bits to 0. The error flags in DIAG\_STAT are sticky, meaning that when they raise to a 1, they remain there until a read request clears them. If an error condition persists, the flag (bit) automatically returns to an alarm value of 1.

### GYROSCOPE DATA

The gyroscopes in the ADIS16500 measure the angular rate of rotation around three orthogonal axes (x, y, and z). Figure 41 shows the orientation of each gyroscope axis along with the direction of rotation that produces a positive response in each of their measurements.

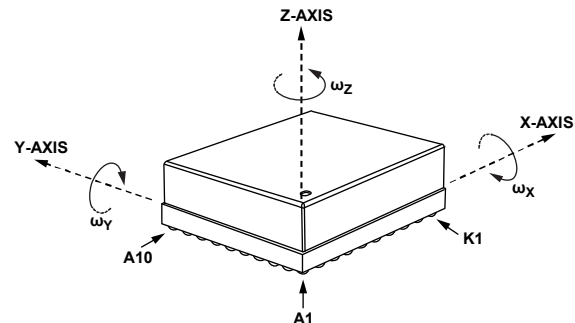

Figure 41. Gyroscope Axis and Polarity Assignments

Each gyroscope has two output data registers. Figure 42 shows how these two registers combine to support a 32-bit, twos complement data format for the x-axis gyroscope measurements. This format also applies to the y- and z-axes.

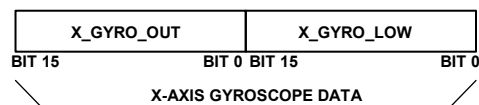

Figure 42. Gyroscope Output Data Structure

### Gyroscope Measurement Range/Scale Factor

Table 12 provides the range and scale factor for the angular rate (gyroscope) measurements in each ADIS16500 model.

Table 12. Gyroscope Measurement Range and Scale Factors

Model	Range, ±ω <sub>MAX</sub> (°/sec)	Scale Factor, K <sub>G</sub> (°/sec/LSB)
ADIS16500AMLZ	±2000	0.1



**Gyroscope Data Formatting**

Table 13 and Table 14 offer various numerical examples that demonstrate the format of the rotation rate data in both 16-bit and 32-bit formats.

**Table 13. 16-Bit Gyroscope Data Format Examples**

Rotation Rate	Decimal	Hex	Binary
+ $\omega_{MAX}$	+20,000	0x4E20	0100 1110 0010 0000
+2 K <sub>G</sub>	+2	0x0002	0000 0000 0000 0010
+K <sub>G</sub>	+1	0x0001	0000 0000 0000 0001
0°/sec	0	0x0000	0000 0000 0000 0000
-K <sub>G</sub>	-1	0xFFFF	1111 1111 1111 1111
-2 K <sub>G</sub>	-2	0xFFFE	1111 1111 1111 1110
- $\omega_{MAX}$	-20,000	0xB1E0	1011 0001 1110 0000

**Table 14. 32-Bit Gyroscope Data Format Examples**

Rotation Rate (°/sec)	Decimal	Hex
+ $\omega_{MAX}$	+1,310,720,000	0x4E200000
+K <sub>G</sub> /2 <sup>15</sup>	+2	0x00000002
+K <sub>G</sub> /2 <sup>16</sup>	+1	0x00000001
0	0	0x00000000
-K <sub>G</sub> /2 <sup>16</sup>	-1	0xFFFFFFFF
-K <sub>G</sub> /2 <sup>15</sup>	-2	0xFFFFFFFFE
- $\omega_{MAX}$	-1,310,720,000	0xB1E00000

**X-Axis Gyroscope (X\_GYRO\_LOW and X\_GYRO\_OUT)****Table 15. X\_GYRO\_LOW Register Definition**

Addresses	Default	Access	Flash Backup
0x04, 0x05	Not applicable	R	No

**Table 16. X\_GYRO\_LOW Bit Definitions**

Bits	Description
[15:0]	X-axis gyroscope data; additional resolution bits

**Table 17. X\_GYRO\_OUT Register Definition**

Addresses	Default	Access	Flash Backup
0x06, 0x07	Not applicable	R	No

**Table 18. X\_GYRO\_OUT Bit Definitions**

Bits	Description
[15:0]	X-axis gyroscope data; high word; twos complement, 0°/sec = 0x0000, 1 LSB = K <sub>G</sub> (See Table 12 for K <sub>G</sub> )

The X\_GYRO\_LOW (see Table 15 and Table 16) and X\_GYRO\_OUT (see Table 17 and Table 18) registers contain the gyroscope data for the x-axis.

**Y-Axis Gyroscope (Y\_GYRO\_LOW and Y\_GYRO\_OUT)****Table 19. Y\_GYRO\_LOW Register Definition**

Addresses	Default	Access	Flash Backup
0x08, 0x09	Not applicable	R	No

**Table 20. Y\_GYRO\_LOW Bit Definitions**

Bits	Description
[15:0]	Y-axis gyroscope data; additional resolution bits

**Table 21. Y\_GYRO\_OUT Register Definition**

Addresses	Default	Access	Flash Backup
0x0A, 0x0B	Not applicable	R	No

**Table 22. Y\_GYRO\_OUT Bit Definitions**

Bits	Description
[15:0]	Y-axis gyroscope data; high word; twos complement, 0°/sec = 0x0000, 1 LSB = K <sub>G</sub> (see Table 12 for K <sub>G</sub> )

The Y\_GYRO\_LOW (see Table 19 and Table 20) and Y\_GYRO\_OUT (see Table 21 and Table 22) registers contain the gyroscope data for the y-axis.

**Z-Axis Gyroscope (Z\_GYRO\_LOW and Z\_GYRO\_OUT)****Table 23. Z\_GYRO\_LOW Register Definition**

Addresses	Default	Access	Flash Backup
0x0C, 0x0D	Not applicable	R	No

**Table 24. Z\_GYRO\_LOW Bit Definitions**

Bits	Description
[15:0]	Z-axis gyroscope data; additional resolution bits

**Table 25. Z\_GYRO\_OUT Register Definition**

Addresses	Default	Access	Flash Backup
0x0E, 0x0F	Not applicable	R	No

**Table 26. Z\_GYRO\_OUT Bit Definitions**

Bits	Description
[15:0]	Z-axis gyroscope data; high word; twos complement, 0°/sec = 0x0000, 1 LSB = K <sub>G</sub> (see Table 12 for K <sub>G</sub> )

The Z\_GYRO\_LOW (see Table 23 and Table 24) and Z\_GYRO\_OUT (see Table 25 and Table 26) registers contain the gyroscope data for the z-axis.

**Acceleration Data**

The accelerometers in the ADIS16500 measure both dynamic and static (response to gravity) acceleration along the same three orthogonal axes that define the axes of rotation for the gyroscopes (x, y, and z). Figure 43 shows the orientation of each accelerometer axis along with the direction of acceleration that produces a positive response in each of their measurements.

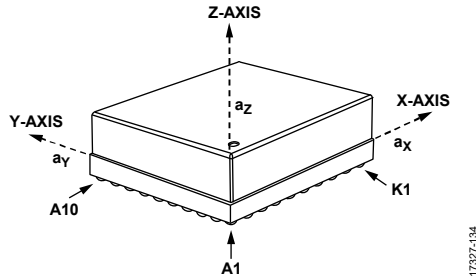

Figure 43. Accelerometer Axis and Polarity Assignments

Each accelerometer has two output data registers. Figure 44 shows how these two registers combine to support a 32-bit, twos complement data format for the x-axis accelerometer measurements. This format also applies to the y- and z-axes.

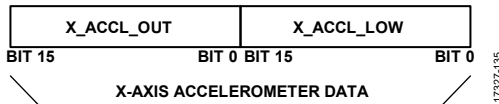

Figure 44. Accelerometer Output Data Structure

**Accelerometer Resolution**

Table 27 and Table 28 offer various numerical examples that demonstrate the format of the linear acceleration data in both 16-bit and 32-bit formats.

**Table 27. 16-Bit Accelerometer Data Format Examples**

Acceleration	Dec	Hex	Binary
+392 m/sec <sup>2</sup>	+32,000	0x7D00	0111 1101 0000 0000
+24.5/2 <sup>15</sup> mm/sec <sup>2</sup>	+2	0x0002	0000 0000 0000 0010
+12.3/2 <sup>16</sup> mm/sec <sup>2</sup>	+1	0x0001	0000 0000 0000 0001
0	0	0x0000	0000 0000 0000 0000
-12.3/2 <sup>16</sup> mm/sec <sup>2</sup>	-1	0xFFFF	1111 1111 1111 1111
-24.5/2 <sup>15</sup> mm/sec <sup>2</sup>	-2	0xFFFE	1111 1111 1111 1110
-392 m/sec <sup>2</sup>	-32,000	0x8300	1000 0011 0000 0000

**Table 28. 32-Bit Accelerometer Data Format Examples**

Acceleration	Decimal	Hex
+392 m/sec <sup>2</sup>	+2,097,152,000	0x7D000000
+24.5/2 <sup>15</sup> mm/sec <sup>2</sup>	+2	0x00000002
+12.3/2 <sup>16</sup> mm/sec <sup>2</sup>	+1	0x00000001
0	0	0x00000000
-12.3/2 <sup>16</sup> mm/sec <sup>2</sup>	-1	0xFFFFFFFF
-24.5/2 <sup>15</sup> mm/sec <sup>2</sup>	-2	0xFFFFFFFFE
-392 m/sec <sup>2</sup>	-2,097,152,000	0x83000000

**X-Axis Accelerometer (X\_ACCL\_LOW and X\_ACCL\_OUT)**

**Table 29. X\_ACCL\_LOW Register Definition**

Addresses	Default	Access	Flash Backup
0x10, 0x11	Not applicable	R	No

**Table 30. X\_ACCL\_LOW Bit Definitions**

Bits	Description
[15:0]	X-axis accelerometer data; additional resolution bits

**Table 31. X\_ACCL\_OUT Register Definition**

Addresses	Default	Access	Flash Backup
0x12, 0x13	Not applicable	R	No

**Table 32. X\_ACCL\_OUT Bit Definitions**

Bits	Description
[15:0]	X-axis accelerometer data, high word; twos complement, $\pm 78.3 \text{ m/sec}^2$ range; $0 \text{ m/sec}^2 = 0x0000$ , 1 LSB = $12.25 \text{ mm/sec}^2$

The X\_ACCL\_LOW (see Table 29 and Table 30) and X\_ACCL\_OUT (see Table 31 and Table 32) registers contain the accelerometer data for the x-axis.

**Y-Axis Accelerometer (Y\_ACCL\_LOW and Y\_ACCL\_OUT)**

**Table 33. Y\_ACCL\_LOW Register Definition**

Addresses	Default	Access	Flash Backup
0x14, 0x15	Not applicable	R	No

**Table 34. Y\_ACCL\_LOW Bit Definitions**

Bits	Description
[15:0]	Y-axis accelerometer data; additional resolution bits

**Table 35. Y\_ACCL\_OUT Register Definition**

Addresses	Default	Access	Flash Backup
0x16, 0x17	Not applicable	R	No

**Table 36. Y\_ACCL\_OUT Bit Definitions**

Bits	Description
[15:0]	Y-axis accelerometer data, high word; twos complement, $\pm 78.3 \text{ m/sec}^2$ range; $0 \text{ m/sec}^2 = 0x0000$ , 1 LSB = $12.25 \text{ mm/sec}^2$

The Y\_ACCL\_LOW (see Table 33 and Table 34) and Y\_ACCL\_OUT (see Table 35 and Table 36) registers contain the accelerometer data for the y-axis.

**Z-Axis Accelerometer (Z\_ACCL\_LOW and Z\_ACCL\_OUT)****Table 37. Z\_ACCL\_LOW Register Definition**

Addresses	Default	Access	Flash Backup
0x18, 0x19	Not applicable	R	No

**Table 38. Z\_ACCL\_LOW Bit Definitions**

Bits	Description
[15:0]	Z-axis accelerometer data; additional resolution bits

**Table 39. Z\_ACCL\_OUT Register Definition**

Addresses	Default	Access	Flash Backup
0x1A, 0x1B	Not applicable	R	No

**Table 40. Z\_ACCL\_OUT Bit Definitions**

Bits	Description
[15:0]	Z-axis accelerometer data, high word; twos complement, $\pm 78.3 \text{ m/sec}^2$ range; $0 \text{ m/sec}^2 = 0x0000$ , 1 LSB = $12.25 \text{ mm/sec}^2$

The Z\_ACCL\_LOW (see Table 37 and Table 38) and Z\_ACCL\_OUT (see Table 39 and Table 40) registers contain the accelerometer data for the z-axis.

**Internal Temperature (TEMP\_OUT)****Table 41. TEMP\_OUT Register Definition**

Addresses	Default	Access	Flash Backup
0x1C, 0x1D	Not applicable	R	No

**Table 42. TEMP\_OUT Bit Definitions**

Bits	Description
[15:0]	Temperature data; twos complement, 1 LSB = $0.1^\circ\text{C}$ , $0^\circ\text{C} = 0x0000$

The TEMP\_OUT register (see Table 41 and Table 42) provides a coarse measurement of the temperature inside of the ADIS16500. This data is most useful for monitoring relative changes in the thermal environment.

**Table 43. TEMP\_OUT Data Format Examples**

Temperature ( $^\circ\text{C}$ )	Decimal	Hex	Binary
+105	+1050	0x041A	0000 0100 0001 1010
+25	+250	0x00FA	0000 0000 1111 1010
+0.2	+2	0x0002	0000 0000 0000 0010
+0.1	+1	0x0001	0000 0000 0000 0001
+0	0	0x0000	0000 0000 0000 0000
+0.1	-1	0xFFFF	1111 1111 1111 1111
+0.2	-2	0xFFFE	1111 1111 1111 1110
-40	-400	0xFE70	1111 1110 0111 0000

**Time Stamp (TIME\_STAMP)****Table 44. TIME\_STAMP Register Definition**

Addresses	Default	Access	Flash Backup
0x1E, 0x1F	Not applicable	R	No

**Table 45. TIME\_STAMP Bit Definitions**

Bits	Description
[15:0]	Time from the last pulse on the SYNC pin; offset binary format, 1 LSB = $49.02 \mu\text{s}$

The TIME\_STAMP register (see Table 44 and Table 45) works in conjunction with scaled sync mode (Register MSC\_CTRL, Bits[3:2] = 10, see Table 106). The 16-bit number in TIME\_STAMP contains the time associated with the last sample in each data update relative to the most recent edge of the clock signal in the SYNC pin. For example, when the value in the UP\_SCALE register (see Table 108) represents a scale factor of 20, DEC\_RATE = 0, and the external SYNC rate = 100 Hz, the following time stamp sequence results: 0 LSB, 10 LSB, 20 LSB, 30 LSB, 40 LSB, 50 LSB, 61 LSB, 71 LSB, ... , 193 LSB for the 20th sample, which translates to  $0 \mu\text{s}$ ,  $490 \mu\text{s}$ , ... ,  $9460 \mu\text{s}$ , the time from the first SYNC edge.

**Data Update Counter (DATA\_CNTR)****Table 46. DATA\_CNTR Register Definition**

Addresses	Default	Access	Flash Backup
0x22, 0x23	Not applicable	R	No

**Table 47. DATA\_CNTR Bit Definitions**

Bits	Description
[15:0]	Data update counter, offset binary format

When the ADIS16500 goes through its power-on sequence or when it recovers from a reset command, DATA\_CNTR (see Table 46 and Table 47) starts with a value of 0x0000 and increments every time new data loads into the output registers. When the DATA\_CNTR value reaches 0xFFFF, the next data update causes it to wrap back around to 0x0000 where it continues to increment every time new data loads into the output registers.

**DELTA ANGLES**

In addition to the angular rate of rotation (gyroscope) measurements around each axis (x, y, and z), the ADIS16500 also provides delta angle measurements that represent a calculation of angular displacement between each sample update.

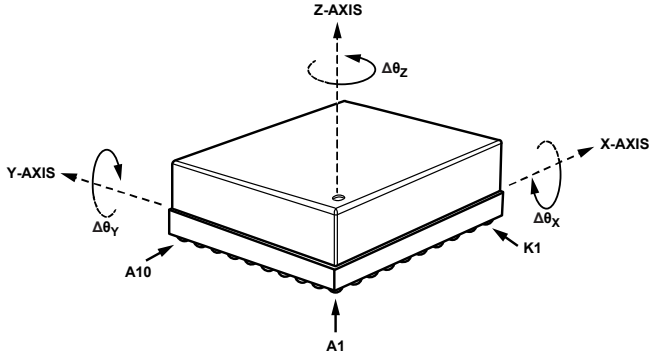

Figure 45. Delta Angle Axis and Polarity Assignments

The delta angle outputs represent an integration of the gyroscope measurements and use the following formula for all three axes (x-axis displayed):

$$\Delta\theta_{x,nD} = \frac{1}{2 \times f_s} \times \sum_{d=0}^{D-1} (\omega_{x,nD+d} + \omega_{x,nD+d-1})$$

where:

$D$  is the decimation rate (DEC\_RATE + 1, see Table 110).

$f_s$  is the sample rate.

$d$  is the incremental variable in the summation formula.

$\omega_x$  is the x-axis rate of rotation (gyroscope).

$n$  is the sample time, prior to the decimation filter.

When using the internal sample clock,  $f_s$  is equal to a nominal rate of 2000 SPS. For better precision in this measurement, measure the internal sample rate ( $f_s$ ) using the data ready signal on the DR pin (DEC\_RATE = 0x0000, see Table 109), divide each delta angle result (from the delta angle output registers) by the data ready frequency, and multiply it by 2000. Each axis of the delta angle measurements has two output data registers. Figure 46 shows how these two registers combine to support a 32-bit, twos complement data format for the x-axis delta angle measurements. This format also applies to the y- and z-axes.

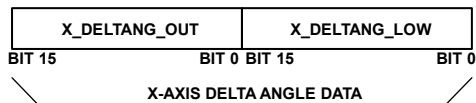

Figure 46. Delta Angle Output Data Structure

**Delta Angle Measurement Range**

Table 48 shows the measurement range and scale factor for the ADIS16500.

Table 48. Delta Angle Measurement Range and Scale Factor

Model	Measurement Range, $\Delta\theta_{MAX}$ (°)
ADIS16500AMLZ	±2160

**X-Axis Delta Angle (X\_DELTANG\_LOW and X\_DELTANG\_OUT)**

Table 49. X\_DELTANG\_LOW Register Definitions

Addresses	Default	Access	Flash Backup
0x24, 0x25	Not applicable	R	No

Table 50. X\_DELTANG\_LOW Bit Definitions

Bits	Description
[15:0]	X-axis delta angle data; low word

Table 51. X\_DELTANG\_OUT Register Definitions

Addresses	Default	Access	Flash Backup
0x26, 0x27	Not applicable	R	No

Table 52. X\_DELTANG\_OUT Bit Definitions

Bits	Description
[15:0]	X-axis delta angle data; twos complement, 0° = 0x0000, 1 LSB = $\Delta\theta_{MAX}/2^{15}$ (see Table 48 for $\Delta\theta_{MAX}$ )

The X\_DELTANG\_LOW (see Table 49 and Table 50) and X\_DELTANG\_OUT (see Table 51 and Table 52) registers contain the delta angle data for the x-axis.

**Y-Axis Delta Angle (Y\_DELTANG\_LOW and Y\_DELTANG\_OUT)**

Table 53. Y\_DELTANG\_LOW Register Definitions

Addresses	Default	Access	Flash Backup
0x28, 0x29	Not applicable	R	No

Table 54. Y\_DELTANG\_LOW Bit Definitions

Bits	Description
[15:0]	Y-axis delta angle data; low word

Table 55. Y\_DELTANG\_OUT Register Definitions

Addresses	Default	Access	Flash Backup
0x2A, 0x2B	Not applicable	R	No

Table 56. Y\_DELTANG\_OUT Bit Definitions

Bits	Description
[15:0]	Y-axis delta angle data; twos complement, 0° = 0x0000, 1 LSB = $\Delta\theta_{MAX}/2^{15}$ (see Table 48 for $\Delta\theta_{MAX}$ )

The Y\_DELTANG\_LOW (see Table 53 and Table 54) and Y\_DELTANG\_OUT (see Table 55 and Table 56) registers contain the delta angle data for the y-axis.

**Z-Axis Delta Angle (Z\_DELTANG\_LOW and Z\_DELTANG\_OUT)**

**Table 57. Z\_DELTANG\_LOW Register Definitions**

Addresses	Default	Access	Flash Backup
0x2C, 0x2D	Not applicable	R	No

**Table 58. Z\_DELTANG\_LOW Bit Definitions**

Bits	Description
[15:0]	Z-axis delta angle data; low word

**Table 59. Z\_DELTANG\_OUT Register Definitions**

Addresses	Default	Access	Flash Backup
0x2E, 0x2F	Not applicable	R	No

**Table 60. Z\_DELTANG\_OUT Bit Definitions**

Bits	Description
[15:0]	Z-axis delta angle data; twos complement, 0° = 0x0000, 1 LSB = Δθ <sub>MAX</sub> /2 <sup>15</sup> (see Table 48 for Δθ <sub>MAX</sub> )

The Z\_DELTANG\_LOW (see Table 57 and Table 58) and Z\_DELTANG\_OUT (see Table 59 and Table 60) registers contain the delta angle data for the z-axis.

**Delta Angle Resolution**

Table 61 and Table 62 show various numerical examples that demonstrate the format of the delta angle data in both 16-bit and 32-bit formats.

**Table 61. 16-Bit Delta Angle Data Format Examples**

Delta Angle (°)	Decimal	Hex	Binary
Δθ <sub>MAX</sub> × (2 <sup>15</sup> - 1) / 2 <sup>15</sup>	+32,767	0x7FFF	0111 1111 1110 1111
+Δθ <sub>MAX</sub> / 2 <sup>14</sup>	+2	0x0002	0000 0000 0000 0010
+Δθ <sub>MAX</sub> / 2 <sup>15</sup>	+1	0x0001	0000 0000 0000 0001
0	0	0x0000	0000 0000 0000 0000
-Δθ <sub>MAX</sub> / 2 <sup>15</sup>	-1	0xFFFF	1111 1111 1111 1111
-Δθ <sub>MAX</sub> / 2 <sup>14</sup>	-2	0xFFFFE	1111 1111 1111 1110
-Δθ <sub>MAX</sub>	-32,768	0x8000	1000 0000 0000 0000

**Table 62. 32-Bit Delta Angle Data Format Examples**

Delta Angle (°)	Decimal	Hex
+Δθ <sub>MAX</sub> × (2 <sup>31</sup> - 1) / 2 <sup>31</sup>	+2,147,483,647	0x7FFFFFFF
+Δθ <sub>MAX</sub> / 2 <sup>30</sup>	+2	0x00000002
+Δθ <sub>MAX</sub> / 2 <sup>31</sup>	+1	0x00000001
0	0	0x00000000
-Δθ <sub>MAX</sub> / 2 <sup>31</sup>	-1	0xFFFFFFFF
-Δθ <sub>MAX</sub> / 2 <sup>30</sup>	-2	0xFFFFFFFFE
-Δθ <sub>MAX</sub>	-2,147,483,648	0x80000000

**DELTA VELOCITY**

In addition to the linear acceleration measurements along each axis (x, y, and z), the ADIS16500 also provides delta velocity measurements that represent a calculation of linear velocity change between each sample update.

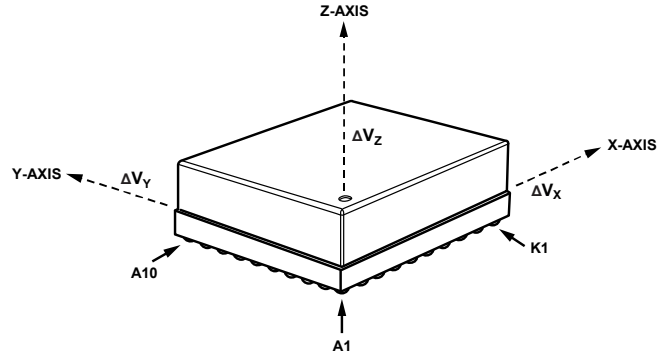

Figure 47. Delta Velocity Axis and Polarity Assignments

The delta velocity outputs represent an integration of the acceleration measurements and use the following formula for all three axes (x-axis displayed):

$$\Delta V_{x,nD} = \frac{1}{2 \times f_s} \times \sum_{d=0}^{D-1} (a_{x,nD+d} + a_{x,nD+d-1})$$

where:

x is the x-axis.

n is the sample time, prior to the decimation filter.

D is the decimation rate (DEC\_RATE + 1, see Table 110).

f<sub>s</sub> is the sample rate.

d is the incremental variable in the summation formula.

a<sub>x</sub> is the x-axis acceleration.

When using the internal sample clock, f<sub>s</sub> is equal to a nominal rate of 2000 SPS. For better precision in this measurement, measure the internal sample rate (f<sub>s</sub>) using the data ready signal on the DR pin (DEC\_RATE = 0x0000, see Table 109), divide each delta angle result (from the delta angle output registers) by the data ready frequency, and multiply it by 2000. Each axis of the delta velocity measurements has two output data registers. Figure 48 shows how these two registers combine to support 32-bit, twos complement data format for the delta velocity measurements along the x-axis. This format also applies to the y- and z-axes.

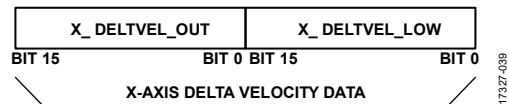

Figure 48. Delta Velocity Output Data Structure

**X-Axis Delta Velocity (X\_DELTVEL\_LOW and X\_DELTVEL\_OUT)****Table 63. X\_DELTVEL\_LOW Register Definition**

Addresses	Default	Access	Flash Backup
0x30, 0x31	Not applicable	R	No

**Table 64. X\_DELTVEL\_LOW Bit Definitions**

Bits	Description
[15:0]	X-axis delta velocity data; additional resolution bits

**Table 65. X\_DELTVEL\_OUT Register Definition**

Addresses	Default	Access	Flash Backup
0x32, 0x33	Not applicable	R	No

**Table 66. X\_DELTVEL\_OUT Bit Definitions**

Bits	Description
[15:0]	X-axis delta velocity data; twos complement, $\pm 400$ m/sec range, 0 m/sec = 0x0000; 1 LSB = $+400 \text{ m/sec} \div 2^{15} = \sim +0.01221$ m/sec

The X\_DELTVEL\_LOW (see Table 63 and Table 64) and X\_DELTVEL\_OUT (see Table 65 and Table 66) registers contain the delta velocity data for the x-axis.

**Y-Axis Delta Velocity (Y\_DELTVEL\_LOW and Y\_DELTVEL\_OUT)****Table 67. Y\_DELTVEL\_LOW Register Definition**

Addresses	Default	Access	Flash Backup
0x34, 0x35	Not applicable	R	No

**Table 68. Y\_DELTVEL\_LOW Bit Definitions**

Bits	Description
[15:0]	Y-axis delta velocity data; additional resolution bits

**Table 69. Y\_DELTVEL\_OUT Register Definition**

Addresses	Default	Access	Flash Backup
0x36, 0x37	Not applicable	R	No

**Table 70. Y\_DELTVEL\_OUT Bit Definitions**

Bits	Description
[15:0]	Y-axis delta velocity data; twos complement, $\pm 400$ m/sec range, 0 m/sec = 0x0000; 1 LSB = $+400 \text{ m/sec} \div 2^{15} = \sim +0.01221$ m/sec

The Y\_DELTVEL\_LOW (see Table 67 and Table 68) and Y\_DELTVEL\_OUT (see Table 69 and Table 70) registers contain the delta velocity data for the y-axis.

**Z-Axis Delta Velocity (Z\_DELTVEL\_LOW and Z\_DELTVEL\_OUT)****Table 71. Z\_DELTVEL\_LOW Register Definition**

Addresses	Default	Access	Flash Backup
0x38, 0x39	Not applicable	R	No

**Table 72. Z\_DELTVEL\_LOW Bit Definitions**

Bits	Description
[15:0]	Z-axis delta velocity data; additional resolution bits

**Table 73. Z\_DELTVEL\_OUT Register Definition**

Addresses	Default	Access	Flash Backup
0x3A, 0x3B	Not applicable	R	No

**Table 74. Z\_DELTVEL\_OUT Bit Definitions**

Bits	Description
[15:0]	Z-axis delta velocity data; twos complement, $\pm 400$ m/sec range, 0 m/sec = 0x0000; 1 LSB = $+400 \text{ m/sec} \div 2^{15} = \sim +0.01221$ m/sec

The Z\_DELTVEL\_LOW (see Table 71 and Table 72) and Z\_DELTVEL\_OUT (see Table 73 and Table 74) registers contain the delta velocity data for the z-axis.

**Delta Velocity Resolution**

Table 75 and Table 76 offer various numerical examples that demonstrate the format of the delta velocity data in both 16-bit and 32-bit formats.

**Table 75. 16-Bit Delta Velocity Data Format Examples**

Velocity (m/sec)	Decimal	Hex	Binary
$+400 \times (2^{15} - 1)/2^{15}$	+32,767	0x7FFF	0111 1111 1111 1111
$+400/2^{14}$	+2	0x0002	0000 0000 0000 0010
$+400/2^{15}$	+1	0x0001	0000 0000 0000 0001
0	0	0x0000	0000 0000 0000 0000
$-400/2^{15}$	-1	0xFFFF	1111 1111 1111 1111
$-400/2^{14}$	-2	0xFFFE	1111 1111 1111 1110
-400	-32,768	0x8000	1000 0000 0000 0000

**Table 76. 32-Bit Delta Velocity Data Format Examples**

Velocity (m/sec)	Decimal	Hex
$+400 \times (2^{31} - 1)/2^{31}$	+2,147,483,647	0x7FFFFFFF
$+400/2^{30}$	+2	0x00000002
$+400/2^{31}$	+1	0x00000001
0	0	0x00000000
$-400/2^{31}$	-1	0xFFFFFFFF
$-400/2^{30}$	-2	0xFFFFFFFF
-400	+2,147,483,648	0x80000000

## CALIBRATION

The signal chain of each inertial sensor (accelerometers and gyroscopes) includes the application of unique correction formulas, which are derived from extensive characterization of bias, sensitivity, alignment, response to linear acceleration (gyroscopes), and point of percussion (accelerometer location) over a temperature range of  $-25^{\circ}\text{C}$  to  $+85^{\circ}\text{C}$ , for each ADIS16500. These correction formulas are not accessible, but users do have the opportunity to adjust the bias for each sensor individually through user accessible registers. These correction factors follow immediately after the factory derived correction formulas in the signal chain, which processes at a rate of 2000 Hz when using the internal sample clock.

### Calibration, Gyroscope Bias (XG\_BIAS\_LOW and XG\_BIAS\_HIGH)

Table 77. XG\_BIAS\_LOW Register Definition

Addresses	Default	Access	Flash Backup
0x40, 0x41	0x0000	R/W	Yes

Table 78. XG\_BIAS\_LOW Bit Definitions

Bits	Description
[15:0]	X-axis gyroscope offset correction; lower word

Table 79. XG\_BIAS\_HIGH Register Definition

Addresses	Default	Access	Flash Backup
0x42, 0x43	0x0000	R/W	Yes

Table 80. XG\_BIAS\_HIGH Bit Definitions

Bits	Description
[15:0]	X-axis gyroscope offset correction factor, upper word

The XG\_BIAS\_LOW (see Table 77 and Table 78) and XG\_BIAS\_HIGH (see Table 79 and Table 80) registers combine to allow users to adjust the bias of the x-axis gyroscopes. The data format examples in Table 13 also apply to the XG\_BIAS\_HIGH register, and the data format examples in Table 14 apply to the 32-bit combination of the XG\_BIAS\_LOW and XG\_BIAS\_HIGH registers. See Figure 49 for an illustration of how these two registers combine and influence the x-axis gyroscope measurements.

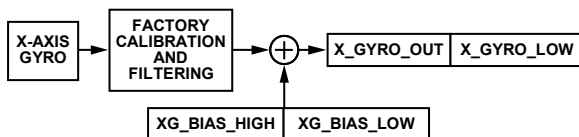

Figure 49. User Calibration Signal Path, Gyroscopes

### Calibration, Gyroscope Bias (YG\_BIAS\_LOW and YG\_BIAS\_HIGH)

Table 81. YG\_BIAS\_LOW Register Definition

Addresses	Default	Access	Flash Backup
0x44, 0x45	0x0000	R/W	Yes

Table 82. YG\_BIAS\_LOW Bit Definitions

Bits	Description
[15:0]	Y-axis gyroscope offset correction; lower word

Table 83. YG\_BIAS\_HIGH Register Definition

Addresses	Default	Access	Flash Backup
0x46, 0x47	0x0000	R/W	Yes

Table 84. YG\_BIAS\_HIGH Bit Definitions

Bits	Description
[15:0]	Y-axis gyroscope offset correction factor, upper word

The YG\_BIAS\_LOW (see Table 81 and Table 82) and YG\_BIAS\_HIGH (see Table 83 and Table 84) registers combine to allow users to adjust the bias of the y-axis gyroscopes. The data format examples in Table 13 also apply to the YG\_BIAS\_HIGH register, and the data format examples in Table 14 apply to the 32-bit combination of the YG\_BIAS\_LOW and YG\_BIAS\_HIGH registers. These registers influence the y-axis gyroscope measurements in the same manner that the XG\_BIAS\_LOW and XG\_BIAS\_HIGH registers influence the x-axis gyroscope measurements (see Figure 49).

### Calibration, Gyroscope Bias (ZG\_BIAS\_LOW and ZG\_BIAS\_HIGH)

Table 85. ZG\_BIAS\_LOW Register Definition

Addresses	Default	Access	Flash Backup
0x48, 0x49	0x0000	R/W	Yes

Table 86. ZG\_BIAS\_LOW Bit Definitions

Bits	Description
[15:0]	Z-axis gyroscope offset correction; lower word

Table 87. ZG\_BIAS\_HIGH Register Definition

Addresses	Default	Access	Flash Backup
0x4A, 0x4B	0x0000	R/W	Yes

Table 88. ZG\_BIAS\_HIGH Bit Definitions

Bits	Description
[15:0]	Z-axis gyroscope offset correction factor, upper word

The ZG\_BIAS\_LOW (see Table 85 and Table 86) and ZG\_BIAS\_HIGH (see Table 87 and Table 88) registers combine to allow users to adjust the bias of the z-axis gyroscopes. The data format examples in Table 13 also apply to the ZG\_BIAS\_HIGH register, and the data format examples in Table 14 apply to the 32-bit combination of the ZG\_BIAS\_LOW and ZG\_BIAS\_HIGH registers.

These registers influence the z-axis gyroscope measurements in the same manner that the XG\_BIAS\_LOW and XG\_BIAS\_HIGH registers influence the x-axis gyroscope measurements (see Figure 49).

**Calibration, Accelerometer Bias (XA\_BIAS\_LOW and XA\_BIAS\_HIGH)**

Table 89. XA\_BIAS\_LOW Register Definition

Addresses	Default	Access	Flash Backup
0x4C, 0x4D	0x0000	R/W	Yes

Table 90. XA\_BIAS\_LOW Bit Definitions

Bits	Description
[15:0]	X-axis accelerometer offset correction; lower word

Table 91. XA\_BIAS\_HIGH Register Definition

Addresses	Default	Access	Flash Backup
0x4E, 0x4F	0x0000	R/W	Yes

Table 92. XA\_BIAS\_HIGH Bit Definitions

Bits	Description
[15:0]	X-axis accelerometer offset correction, upper word

The XA\_BIAS\_LOW (see Table 89 and Table 90) and XA\_BIAS\_HIGH (see Table 91 and Table 92) registers combine to allow users to adjust the bias of the x-axis accelerometers. The data format examples in Table 27 also apply to the XA\_BIAS\_HIGH register and the data format examples in Table 28 apply to the 32-bit combination of the XA\_BIAS\_LOW and XA\_BIAS\_HIGH registers. See Figure 50 for an illustration of how these two registers combine and influence the x-axis accelerometer measurements.

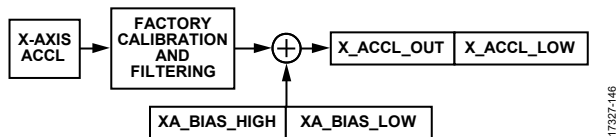

Figure 50. User Calibration Signal Path, Accelerometers

**Calibration, Accelerometer Bias (YA\_BIAS\_LOW and YA\_BIAS\_HIGH)**

Table 93. YA\_BIAS\_LOW Register Definition

Addresses	Default	Access	Flash Backup
0x50, 0x51	0x0000	R/W	Yes

Table 94. YA\_BIAS\_LOW Bit Definitions

Bits	Description
[15:0]	Y-axis accelerometer offset correction; lower word

Table 95. YA\_BIAS\_HIGH Register Definition

Addresses	Default	Access	Flash Backup
0x52, 0x53	0x0000	R/W	Yes

Table 96. YA\_BIAS\_HIGH Bit Definitions

Bits	Description
[15:0]	Y-axis accelerometer offset correction, upper word

The YA\_BIAS\_LOW (see Table 93 and Table 94) and YA\_BIAS\_HIGH (see Table 95 and Table 96) registers combine to allow users to adjust the bias of the y-axis accelerometers. The data format examples in Table 27 also apply to the YA\_BIAS\_HIGH register, and the data format examples in Table 28 apply to the 32-bit combination of the YA\_BIAS\_LOW and YA\_BIAS\_HIGH registers. These registers influence the y-axis accelerometer measurements in the same manner that the XA\_BIAS\_LOW and XA\_BIAS\_HIGH registers influence the x-axis accelerometer measurements (see Figure 50).

**Calibration, Accelerometer Bias (ZA\_BIAS\_LOW and ZA\_BIAS\_HIGH)**

Table 97. ZA\_BIAS\_LOW Register Definition

Addresses	Default	Access	Flash Backup
0x54, 0x55	0x0000	R/W	Yes

Table 98. ZA\_BIAS\_LOW Bit Definitions

Bits	Description
[15:0]	Z-axis accelerometer offset correction; lower word

Table 99. ZA\_BIAS\_HIGH Register Definition

Addresses	Default	Access	Flash Backup
0x56, 0x57	0x0000	R/W	Yes

Table 100. ZA\_BIAS\_HIGH Bit Definitions

Bits	Description
[15:0]	Z-axis accelerometer offset correction, upper word

The ZA\_BIAS\_LOW (see Table 97 and Table 98) and ZA\_BIAS\_HIGH (see Table 99 and Table 100) registers combine to allow users to adjust the bias of the z-axis accelerometers. The data format examples in Table 27 also apply to the ZA\_BIAS\_HIGH register and the data format examples in Table 28 apply to the 32-bit combination of the ZA\_BIAS\_LOW and ZA\_BIAS\_HIGH registers. These registers influence the z-axis accelerometer measurements in the same manner that the XA\_BIAS\_LOW and XA\_BIAS\_HIGH registers influence the x-axis accelerometer measurements (see Figure 50).



**Filter Control Register (FILT\_CTRL)**

**Table 101. FILT\_CTRL Register Definition**

Addresses	Default	Access	Flash Backup
0x5C, 0x5D	0x0000	R/W	Yes

**Table 102. FILT\_CTRL Bit Definitions**

Bits	Description
[15:3]	Not used
[2:0]	Filter Size Variable B; number of taps in each stage; $N = 2^B$ , where $B = 0$ to 6 (decimal). Changes to this register may take up to 30 $\mu$ s after writing to indicate the new value during readback.

The FILT\_CTRL register (see Table 101 and Table 102) provides user controls for the Bartlett window FIR filter (see Figure 24), which contains two cascaded averaging filters. For example, use the following sequence to set Register FILT\_CTRL, Bits[2:0] = 0100, which sets each stage to have 16 taps: 0xCC04 and 0xCD00. Figure 51 provides the frequency response for several settings in the FILT\_CTRL register.

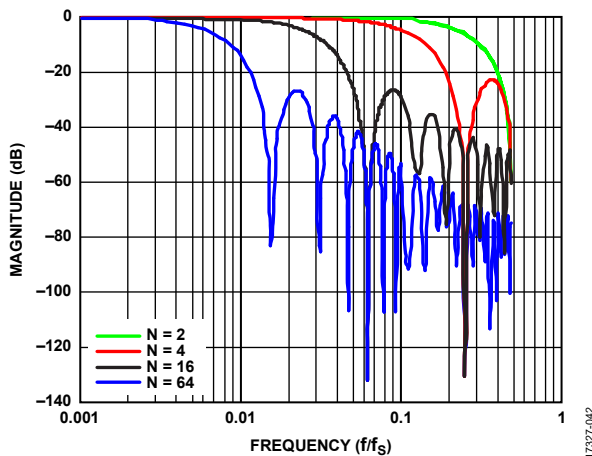

Figure 51. Bartlett Window, FIR Filter Frequency Response (Phase Delay = N Samples)

**Range Identifier (RANG\_MDL)**

**Table 103. RANG\_MDL Register Definition**

Addresses	Default	Access	Flash Backup
0x5E, 0x5F	Not applicable	R	No

**Table 104. RANG\_MDL Bit Definitions**

Bits	Description
[15:3]	Not used
[3:2]	Gyroscope measurement range 00 = reserved 01 = reserved 10 = reserved 11 = $\pm 2000^\circ/\text{sec}$ (ADIS16500AMLZ)
[1:0]	Reserved, binary value = 11

**Miscellaneous Control Register (MSC\_CTRL)**

**Table 105. MSC\_CTRL Register Definition**

Addresses	Default	Access	Flash Backup
0x60, 0x61	0x00C1	R/W	Yes

**Table 106. MSC\_CTRL Bit Definitions**

Bits	Description
[15:10]	Not used
9	BURST32. 32-bit burst enable bit. The user must wait until a full data ready cycle until the burst array updates with the desired data type. Changes to this bit may take up to 200 $\mu$ s after writing to indicate the new value during readback. 1 = 32-bit burst data. 0 = 16-bit burst data (default).
8	BURST_SEL. Burst read output array selection. This bit controls what calibrated data is in a burst read. Changes to this bit may take up to 200 $\mu$ s after writing to indicate the new value during readback. 1 = burst data has delta angle and delta velocity data. 0 = burst data has gyroscope and accelerometer data (default).
7	Linear acceleration compensation for gyroscopes. When enabled, factory calibrated linear acceleration compensation data is applied to the gyroscope outputs. Changes to this bit may take up to 200 $\mu$ s after writing to indicate the new value during readback. 1 = enabled. 0 = disabled (default).
6	Point of percussion alignment. When set, this bit allows for relocation of the acceleration sensors to a common point of percussion on the package corner by considering angular rotations. Changes to this bit may take up to 200 $\mu$ s after writing to indicate the new value during readback. 1 = enabled. 0 = disabled (default).
5	Not used. Always set to 0.
4	SENS_BW. Internal sensor bandwidth. Changing this bit reinitializes the sensors, and the user must wait until the DR pin starts toggling after changing this bit. This operation may require up to 250 ms to complete. 0 = wide bandwidth (default), see Table 1. 1 = 370 Hz. The gyroscope group delay increases by 0.17 ms and the accelerometer group delay increases by 0.63 ms in this mode.
[3:2]	SYNC mode select (see the Clock Control section for more information). The user must wait until the DR pin starts toggling after changing these bits and/or the UP_SCALE register to correctly read back the new values. However, the user can write these registers in succession before waiting for the DR pin to resume toggling. 00 = internal SYNC (default). Internal 2 kHz clock used. 01 = direct input sync mode. The user provides an external input clock between 1900 Hz and 2100 Hz. 10 = scaled sync mode. The user provides an external input clock between 1 Hz and 128 Hz, which upscales to 1900 Hz to 2100 Hz inside the ADIS16500.

Bits	Description
	11 = output sync mode. Identical to internal sync mode, except the SYNC pin functions as an output signal, indicating when the internal clock samples sensors.
1	SYNC polarity (input or output). Changes to this bit may take up to 200 $\mu$ s after writing to indicate the new value during readback. 1 = rising edge triggers sampling. 0 = falling edge triggers sampling (default).
0	DR polarity. This bit controls the polarity of the DR pin. Changes to this bit may take up to 200 $\mu$ s after writing to indicate the new value during readback. 1 = active high when data is valid. 0 = active low when data is valid (default).

### Point of Percussion

Register MSC\_CTRL, Bit 6 (see Table 106) offers an on/off control for the point of percussion alignment function, which maps the accelerometer sensors to the corner of the package that is closest to Pin A1 (see Figure 52). The factory default setting in the MSC\_CTRL register activates this function. To turn this function off while retaining the rest of the factory default settings in the MSC\_CTRL register, set Register MSC\_CTRL, Bit 6 = 0 using the following command sequence on the DIN pin: 0xE081, then 0xE100.

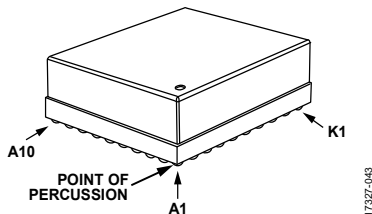

Figure 52. Point of Percussion Reference Point

### Linear Acceleration Effect on Gyroscope Bias

Register MSC\_CTRL, Bit 7 (see Table 106) provides an on/off control for the linear acceleration compensation in the signal calibration routines of the gyroscope. The factory default contents in the MSC\_CTRL register enable this compensation. To turn the compensation off, set Register MSC\_CTRL, Bit 7 = 0 using the following sequence on the DIN pin: 0xE041, 0xEF00.

### Sync Mode Select

Refer to the Clock Control section for the functions of the sync mode select bits.

### Sync Input Frequency Multiplier (UP\_SCALE)

Table 107. UP\_SCALE Register Definition

Addresses	Default	Access	Flash Backup
0x62, 0x63	0x07D0	R/W	Yes

Table 108. UP\_SCALE Bit Definitions

Bits	Description
[15:0]	$K_{ESCF}$ ; binary format. The user must wait until the DR pin starts toggling after changing this register and/or MSC_CTRL[3:2] to correctly read back the new values. However, the user can write these registers in succession before waiting for the DR pin to resume toggling.

Refer to the Clock Control section for the function and programming of the UP\_SCALE register.

### Decimation Filter (DEC\_RATE)

Table 109. DEC\_RATE Register Definition

Addresses	Default	Access	Flash Backup
0x64, 0x65	0x0000	R/W	Yes

Table 110. DEC\_RATE Bit Definitions

Bits	Description
[15:11]	Don't care
[10:0]	Decimation rate, binary format, maximum = 1999. Changes to this register may take up to 30 $\mu$ s after writing to indicate the new value during readback.

The DEC\_RATE register (see Table 109 and Table 110) provides user control for the averaging decimating filter, which averages and decimates the gyroscope and accelerometer data; it also extends the time that the delta angle and the delta velocity track between each update. When the ADIS16500 operates in internal clock mode (see Register MSC\_CTRL, Bits[3:2], in Table 106), the nominal output data rate is equal to  $2000/(DEC\_RATE + 1)$ . For example, set DEC\_RATE = 0x0013 to reduce the output sample rate to 100 SPS ( $2000 \div 20$ ) using the following DIN pin sequence: 0xE413, then 0xE500.

### Data Update Rate in External Sync Modes

When using the input sync option in scaled sync mode (Register MSC\_CTRL, Bits[3:2] = 10, see Table 106), the output data rate is equal to

$$(f_{SYNC} \times K_{ESCF}) / (DEC\_RATE + 1)$$

where:

$f_{SYNC}$  is the frequency of the clock signal on the SYNC pin.

$K_{ESCF}$  is the value from the UP\_SCALE register (see Table 108).

When using direct sync mode,  $K_{ESCF} = 1$ .

### Global Commands (GLOB\_CMD)

Table 111. GLOB\_CMD Register Definition

Addresses	Default	Access	Flash Backup
0x68, 0x69	Not applicable	W	No

Table 112. GLOB\_CMD Bit Definitions

Bits	Description
[15:8]	Not used
7	Software reset
[6:5]	Not used
4	Flash memory test
3	Flash memory update
2	Sensor self test
1	Factory calibration restore
0	Not used

The GLOB\_CMD register (see Table 111 and Table 112) provides trigger bits for several operations. Write a 1 to the appropriate bit in GLOB\_CMD to start a particular function. During the execution of these commands, data production stops, pulsing stops on the DR pin, and the SPI interface does not respond to requests.

Table 1 provides the execution time for each GLOB\_CMD command.

### Software Reset

Use the following DIN sequence to set Register GLOB\_CMD, Bit 7 = 1, which triggers a reset: 0xE880, then 0xE900. This reset clears all data, and then restarts data sampling and processing. This function provides a firmware alternative to toggling the RST pin (see Table 5, Pin F3).

### Flash Memory Test

Use the following DIN sequence to set Register GLOB\_CMD, Bit 4 = 1, which tests the flash memory: 0xE810, then 0xE900. The command performs a CRC computation on the flash memory (excluding user register locations) and compares it to the original CRC value, which comes from the factory configuration process. If the current CRC value does not match the original CRC value, Register DIAG\_STAT, Bit 6 (see Table 11), rises to 1, indicating a failing result.

### Flash Memory Update

Use the following DIN sequence to set Register GLOB\_CMD, Bit 3 = 1, which triggers a backup of all user configurable registers in the flash memory: 0xE808, then 0xE900. Register DIAG\_STAT, Bit 2 (see Table 11), identifies success (0) or failure (1) in completing this process.

### Sensor Self Test

Use the following DIN sequence to set Register GLOB\_CMD, Bit 2 = 1, which triggers the self test routine for the inertial sensors: 0xE804, then 0xE900. The self test routine uses the following steps to validate the integrity of each inertial sensor:

1. Measure the output on each sensor.
2. Activate an internal stimulus on the mechanical elements of each sensor to move them in a predictable manner and create an observable response in the sensors.
3. Measure the output response on each sensor.
4. Deactivate the internal stimulus on each sensor.
5. Calculate the difference between the sensor measurements from Step 1 (stimulus is off) and from Step 4 (stimulus is on).
6. Compare the difference with internal pass and fail criteria.
7. Report the pass and fail result to Register DIAG\_STAT, Bit 5 (see Table 11).

Motion during the execution of this test can indicate a false failure.

### Factory Calibration Restore

Use the following DIN sequence to set Register GLOB\_CMD, Bit 1 = 1, to restore the factory default settings for the MSC\_CTRL, DEC\_RATE, and FILT\_CTRL registers and to clear all user configurable bias correction settings: 0xE802, then 0xE900. Executing this command results in writing 0x0000 to the following registers: XG\_BIAS\_LOW, XG\_BIAS\_HIGH, YG\_BIAS\_LOW, YG\_BIAS\_HIGH, ZG\_BIAS\_LOW, ZG\_BIAS\_HIGH, XA\_BIAS\_LOW, XA\_BIAS\_HIGH, YA\_BIAS\_LOW, YA\_BIAS\_HIGH, ZA\_BIAS\_LOW, and ZA\_BIAS\_HIGH.

## Firmware Revision (FIRM\_REV)

Table 113. FIRM\_REV Register Definition

Addresses	Default	Access	Flash Backup
0x6C, 0x6D	Not applicable	R	Yes

Table 114. FIRM\_REV Bit Definitions

Bits	Description
[15:0]	Firmware revision, binary coded decimal (BCD) format

The FIRM\_REV register (see Table 113 and Table 114) provides the firmware revision for the internal firmware. This register uses a BCD format where each nibble represents a digit. For example, if FIRM\_REV = 0x0104, the firmware revision is 1.04.

## Firmware Revision Day and Month (FIRM\_DM)

Table 115. FIRM\_DM Register Definition

Addresses	Default	Access	Flash Backup
0x6E, 0x6F	Not applicable	R	Yes

Table 116. FIRM\_DM Bit Definitions

Bits	Description
[15:8]	Factory configuration month, BCD format
[7:0]	Factory configuration day, BCD format

The FIRM\_DM register (see Table 115 and Table 116) contains the month and day of the factory configuration date. Register FIRM\_DM, Bits[15:8], contain digits that represent the month of the factory configuration. For example, November is the 11<sup>th</sup> month in a year and is represented by Register FIRM\_DM, Bits[15:8] = 0x11. Register FIRM\_DM, Bits[7:0], contain the day of factory configuration. For example, the 27<sup>th</sup> day of the month is represented by Register FIRM\_DM, Bits[7:0] = 0x27.

## Firmware Revision Year (FIRM\_Y)

Table 117. FIRM\_Y Register Definition

Addresses	Default	Access	Flash Backup
0x70, 0x71	Not applicable	R	No

Table 118. FIRM\_Y Bit Definitions

Bits	Description
[15:0]	Factory configuration year, BCD format

The FIRM\_Y register (see Table 117 and Table 118) contains the year of the factory configuration date. For example, the year, 2017, is represented by FIRM\_Y = 0x2017.

**Product Identification (PROD\_ID)**

**Table 119. PROD\_ID Register Definition**

Addresses	Default	Access	Flash Backup
0x72, 0x73	0x4074	R	Yes

**Table 120. PROD\_ID Bit Definitions**

Bits	Description
[15:0]	Product identification = 0x4074

The PROD\_ID register (see Table 119 and Table 120) contains the numerical portion of the device number (16,500). See Figure 34 for an example of how to use a looping read of this register to validate the integrity of the communication.

**Serial Number (SERIAL\_NUM)**

**Table 121. SERIAL\_NUM Register Definition**

Addresses	Default	Access	Flash Backup
0x74, 0x75	Not applicable	R	Yes

**Table 122. SERIAL\_NUM Bit Definitions**

Bits	Description
[15:0]	Lot specific serial number

**Scratch Registers (USER\_SCR\_1 to USER\_SCR\_3)**

**Table 123. USER\_SCR\_1 Register Definition**

Addresses	Default	Access	Flash Backup
0x76, 0x77	Not applicable	R/W	Yes

**Table 124. USER\_SCR\_1 Bit Definitions**

Bits	Description
[15:0]	User defined

**Table 125. USER\_SCR\_2 Register Definition**

Addresses	Default	Access	Flash Backup
0x78, 0x79	Not applicable	R/W	Yes

**Table 126. USER\_SCR\_2 Bit Definitions**

Bits	Description
[15:0]	User defined

**Table 127. USER\_SCR\_3 Register Definition**

Addresses	Default	Access	Flash Backup
0x7A, 0x7B	Not applicable	R/W	Yes

**Table 128. USER\_SCR\_3 Bit Definitions**

Bits	Description
[15:0]	User defined

The USER\_SCR\_1 (see Table 123 and Table 124), USER\_SCR\_2 (see Table 125 and Table 126), and USER\_SCR\_3 (see Table 127

and Table 128) registers provide three locations for the user to store information. For nonvolatile storage, use the manual flash memory update command (Register GLOB\_CMD, Bit 3, see Table 112) after writing information to these registers.

**Flash Memory Endurance Counter (FLSHCNT\_LOW and FLSHCNT\_HIGH)**

**Table 129. FLSHCNT\_LOW Register Definition**

Addresses	Default	Access	Flash Backup
0x7C, 0x7D	Not applicable	R	Yes

**Table 130. FLSHCNT\_LOW Bit Definitions**

Bits	Description
[15:0]	Flash memory write counter, low word

**Table 131. FLSHCNT\_HIGH Register Definition**

Addresses	Default	Access	Flash Backup
0x7E, 0x7F	Not applicable	R	Yes

**Table 132. FLSHCNT\_HIGH Bit Definitions**

Bits	Description
[15:0]	Flash memory write counter, high word

The FLSHCNT\_LOW (see Table 129 and Table 130) and FLSHCNT\_HIGH (see Table 131 and Table 132) registers combine to provide a 32-bit, binary counter that tracks the number of flash memory write cycles. In addition to the number of write cycles, the flash memory has a finite service lifetime, which depends on the junction temperature. Figure 53 provides guidance for estimating the retention life for the flash memory at specific junction temperatures. The junction temperature is approximately 7°C above the case temperature.

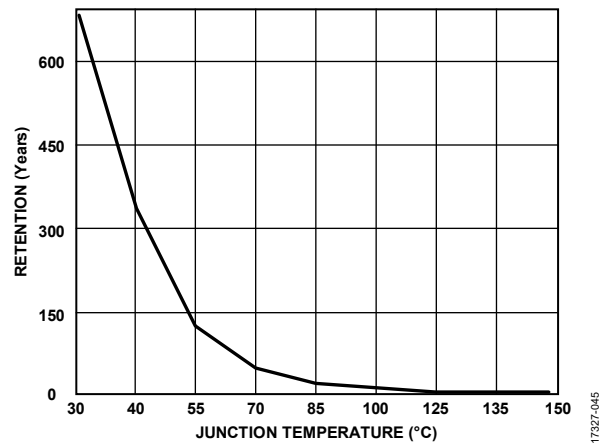

Figure 53. Flash Memory Retention

## APPLICATIONS INFORMATION

### ASSEMBLY AND HANDLING TIPS

#### Package Attributes

The ADIS16500 is a multichip module package that has a 100-ball BGA interface. This package has three basic attributes that influence its handling and assembly to the PCB of the system: the lid, the substrate, and the BGA pattern. The material of the lid is a liquid crystal polymer (LCP), and its nominal thickness is 0.5 mm. The substrate is a laminate that has a nominal thickness of 1.57 mm. The solder ball material is SAC305, and each ball has a nominal diameter of 0.75 mm ( $\pm 0.15$  mm). The BGA pattern is a  $10 \times 10$  array.

All electrical and physical connections are through the  $10 \times 10$  array shown in Figure 55. The bottom view in Figure 59 shows additional features from the manufacture of the ADIS16500 that are not relevant to the mounting or use of the ADIS16500.

#### Assembly Tips

When attaching the ADIS16500 to a PCB, follow these guidelines:

- The ADIS16500 supports solder reflow attachment processes in accordance with J-STD-020E.
- Limit device exposure to one pass through the solder reflow process (no rework).
- The hole in the top of the lid (see Figure 54) provides venting and pressure relief during the assembly process of the ADIS16500. This hole must be kept clear while attaching the ADIS16500 to a PCB. Although, covering the hole in normal operation is not typically a problem.

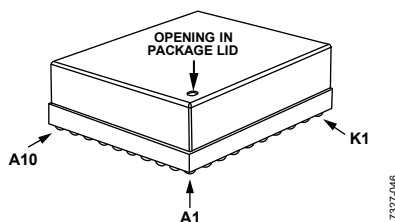

Figure 54. Pressure Relief Hole

- Use no clean flux and avoid exposing the device to cleaning solvents that can penetrate the inside of the ADIS16500 through multiple paths.
- Manage moisture exposure prior to the solder reflow processing in accordance with J-STD-033, Moisture Sensitivity Level 5.
- Avoid exposing the ADIS16500 to mechanical shock survivability that exceeds the maximum rating in Table 3. In standard PCB processing, high speed handling equipment and panel separation processes often present the most risk of introducing harmful levels of mechanical shock survivability.

#### PCB Layout Suggestions

Figure 55 shows an example of the pad design and layout for the ADIS16500 on a PCB. This example uses a solder mask opening with a diameter of 0.73 mm around a metal pad that has a diameter of 0.56 mm. When using a material for the system PCB that has similar thermal expansion properties as the substrate material of the ADIS16500, the system PCB can also use the solder mask to define the pads that support attachment to the balls of the ADIS16500. The coefficient of thermal expansion (CTE) in the substrate of the ADIS16500 is approximately 14 ppm/°C.

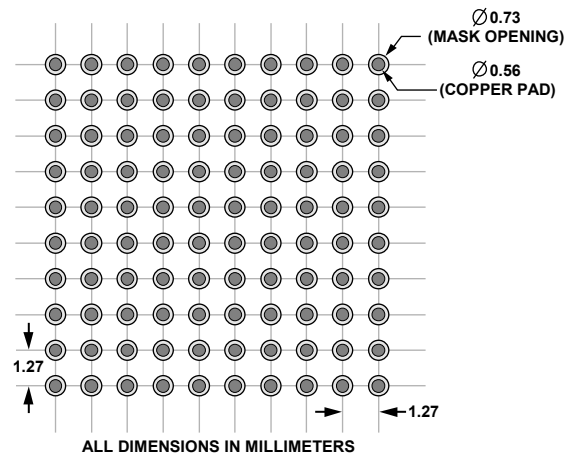

Figure 55. Recommend PCB Pattern, Solder Mask Defined Pads

#### Underfill

Underfill can be a useful technique in managing certain threats to the integrity of the solder joints of the ADIS16500, including peeling stress and extended exposure to vibration. When selecting underfill material and developing an application and curing process, ensure that the material fills the gap between each surface (the ADIS16500 substrate and system PCB) and adheres to both surfaces. The ADIS16500 does not require the use of underfill materials in applications that do not anticipate exposure to these types of mechanical stresses and when the CTE of the system PCB is close to the same value as the CTE of the substrate of the ADIS16500 ( $\sim 14$  ppm/°C).

#### Process Validation and Control

These guidelines provide a starting point for developing a process for attaching the ADIS16500 to a system PCB. Because each system and situation can present unique requirements for this attachment process, ensure that the process supports optimal solder joint integrity, verify that the final system meets all environmental test requirements, and establish observation and control strategies for all key process attributes (for example, peak temperatures, dwell times, and ramp rates).

**POWER SUPPLY CONSIDERATIONS**

The ADIS16500 contains 6 μF of decoupling capacitance across the VDD and GND pins. When the VDD voltage rises from 0 V to 3.3 V, the charging current for this capacitor bank imposes the following current profile (in amperes):

$$I_{DD}(t) = C \frac{dVDD}{dt} = 6 \times 10^{-6} \times \frac{dVDD(t)}{dt}$$

where:

$I_{DD}(t)$  is the current demand on the VDD pin during the initial power supply ramp, with respect to time.

$C$  is the internal capacitance across the VDD and GND pins (6 μF).

$VDD(t)$  is the voltage on the VDD pin, with respect to time.

For example, if VDD follows a linear ramp from 0 V to 3.3 V, in 66 μs, the charging current is 300 mA for that timeframe. The ADIS16500 also contains embedded processing functions that present transient current demands during initialization or reset recovery operations. During these processes, the peak current demand reaches 250 mA and occurs at a time that is approximately 40 ms after VDD reaches 3.0 V (or ~40 ms after initiating a reset sequence).

**EVALUATION TOOLS**

**Breakout Boards**

The ADIS16500 has a breakout board that provides a simple way to connect an ADIS16500 model and an existing embedded processor platform. The model number of the ADIS16500 breakout board is ADIS16500/PCBZ. Figure 56 shows the [ADIS16505-2](#) board that is identical to the ADIS16500 board.



Figure 56. ADIS16500 Breakout Board (ADIS16505-2 Shown)

The electrical interface (J1) on the breakout board comes from a dual row, 2 mm pitch, 16-pin interface that supports standard ribbon cabling (1 mm pitch). Table 133 provides the J1 pin assignments that support direct connection with an embedded processor board using standard ribbon cables. Although each case may present its own set of sensitivities (such as electro-magnetic interference (EMI)), these boards can typically support reliable communication over ribbon cables up to 20 cm in length.

**Table 133. J1 Pin Assignments, Breakout Board**

J1 Pin Number	Signal	Function
1	RST	Reset
2	SCLK	SPI
3	CS	SPI
4	DOUT	SPI
5	NC	No connect
6	DIN	SPI
7	GND	Ground
8	GND	Ground
9	GND	Ground
10	VDD	Power, 3.3 V
11	VDD	Power, 3.3 V
12	VDD	Power, 3.3 V
13	DR	Data ready
14	SYNC	Input clock
15	NC	No connect
16	NC	No connect

Figure 57 provides a top view of the breakout board, including dimensional locations for all the key mechanical features, such as the mounting holes and the 16-pin header. Figure 58 provides an electrical schematic for this breakout board. For additional information, refer to the [ADIS1650x-x/PCBZ Breakout Board Wiki Guide](#).

**PC-Based Evaluation, EVAL-ADIS2**

In addition to supporting quick prototype connections between the ADIS16500 and an embedded processing system, J1 on the breakout boards also connects directly to J1 on the [EVAL-ADIS2](#) evaluation system. When used in conjunction with the [IMU Evaluation Software for the EVAL-ADISX Platforms](#), the [EVAL-ADIS2](#) provides a simple, functional test platform that allows users to configure and collect data from the ADIS16500 IMUs.



PACKAGING AND ORDERING INFORMATION

OUTLINE DIMENSIONS

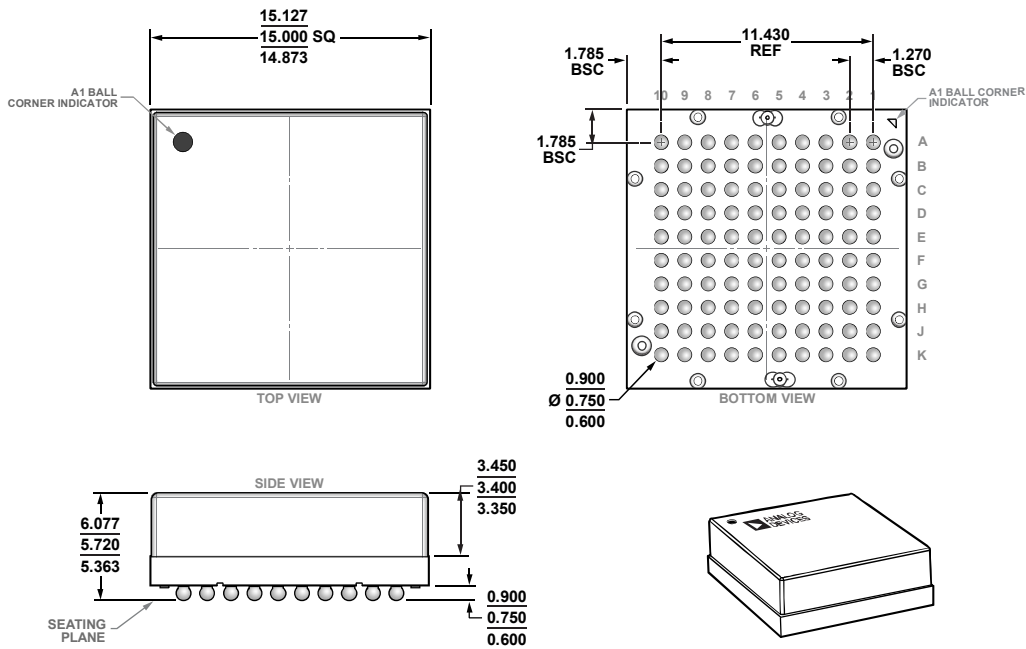

Figure 59. 100-Ball Ball Grid Array Module [BGA]  
(ML-100-1)  
Dimensions shown in millimeters

04-11-2016-A

ORDERING GUIDE

Model <sup>1</sup>	Temperature Range	Package Description	Package Option
ADIS16500AMLZ	-25°C to +85°C	100-Ball Ball Grid Array Module [BGA]	ML-100-1
ADIS16500/PCBZ		ADIS16500 Breakout Board	

<sup>1</sup> Z = RoHS Compliant Part.