

UPDATE

Power Choke Coil (Automotive Grade)

PCC-M0530M, M0540M, M0630M, M0645M series

PCC-M0754M, M0750M, M0854M, M0850M series

PCC-M1054M, M1050M, M1050ML, M1060ML series

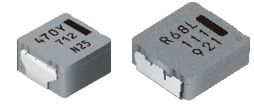

High heat resistance and high reliability using metal composite core (MC)

Industrial property : Patents 21 (Registered 2 / Pending 19)

Features

- High heat resistance : Operation up to 150 °C including self-heating
- High-reliability : High vibration resistance as result of newly developed integral construction; under severe reliability conditions of automotive and other strenuous applications
- High bias current : Excellent inductance stability using ferrous alloy magnetic material (Fig.1)
- Temp. stability : Excellent inductance stability over broad temp. range (Fig.1)
- Low audible (buzz) noise : A gapless structure achieved with metal composite core
- High efficiency : Low DC resistance of winding and low eddy-current loss of the core
- Shielded construction
- AEC-Q200 compliant
- RoHS compliant

● Fig.1

Inductance v.s. DC current, Temp. ETQP5M470YFM (reference)

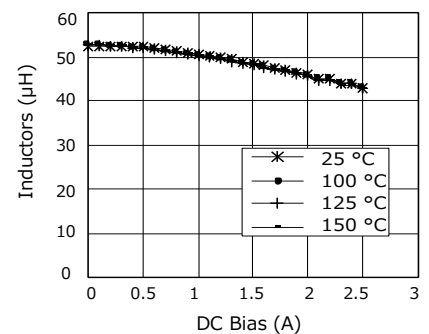

Recommended applications

- Noise filter for various drive circuitry requiring high temp. operation and peak current handling capability
- Boost-Converter, Buck-Converter DC/DC

Standard packing quantity (Minimum quantity/Packing unit)

- 1,000 pcs/box (2 reel) : PCC - M0645M, M0754M, M0750M, M0854M, M0850M, M1054M, M1050M, M1050ML, M1060ML
- 2,000 pcs/box (2 reel) : PCC - M0530M, M0540M, M0630M

Explanation of part numbers

1	2	3	4	5	6	7	8	9	10	11	12
E	T	Q	P		M				Y		
Product code	Classification	Height	Winding	Inductance	Core	Suffix	Size				

Code	Inductance
4R7	4.7 µH
220	22 µH
101	100 µH

Code	Size
P	□ 5 mm
N	□ 6 mm
M	□ 7 mm
K	□ 8 mm
C	□ 10 mm

Temperature rating

Operating temperature range		Tc : -40 °C to +150 °C (Including self-temperature rise)
Storage condition	After PWB mounting	
	Before PWB mounting	Ta : -5 °C to +35 °C 85%RH max.

1. Series PCC-M0530M/PCC-M0540M (ETQP3M□□□YFP/ETQP4M□□□YFP)

Standard parts

Part No.	Inductance *1		DCR (at 20 °C) (mΩ)		Rated current (A) Typ.		MSL level *5	Series [Size (mm)]
	L0 (μH)	Tolerance (%)	Typ. (max.)	Tolerance (%)	$\Delta T = 40 \text{ K}^{*2}$ () ^{*3}	$\Delta L = -30 \%^{*4}$		
ETQP3M2R2YFP	2.2	±20	22.6 (24.8)	±10	5.8 (4.8)	10.9	1	PCC-M0530M
ETQP3M3R3YFP	3.3		31.3 (34.4)		5.0 (4.1)	8.6	1	
ETQP4M4R7YFP	4.6		36.0 (39.6)		4.8 (4.0)	7.7	1	PCC-M0540M
ETQP4M220YFP	22.0		163.0 (179.0)		2.3 (1.9)	3.1	1	[5.5×5.0×4.0]

*1: Measured at 100 kHz

*2: The proved current value for making the overall temperature rise of 40K, when mounted on a multi-layer board with high-heat dissipation (heat dissipation constant 5.5x5.0x3.0 mm : approx. 52 K/W, 5.5x5.0x4.0 mm : approx. 48 K/W).

*3: The proved current value for making the overall temperature rise of 40K, when mounted on a 4-layer circuit board of FR4 t=1.6 mm and DC current is applied.

*4: Saturation rated current : DC current which causes L(0) drop -30 %.

*5: The solderability is guaranteed for 1 year only. The product out of expiration date shall not be used.

◆ Within a suitable application, the part's temperature depends on circuit design and certain heat dissipation conditions. This should be double checked in a worst case operation mode. In normal case, the max.standard operating temperature of +150°C should not be exceeded. For higher operating temperature conditions, please contact Panasonic representative in your area.

Performance characteristics (Reference①)

● Inductance vs DC Current

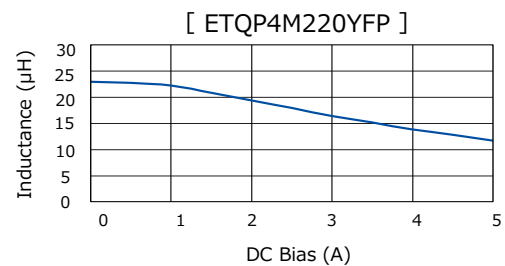
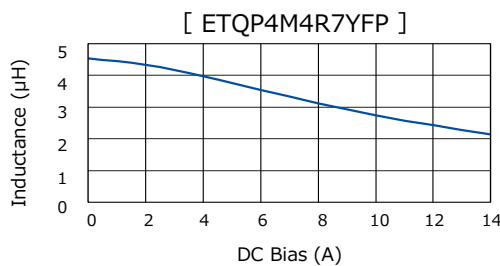
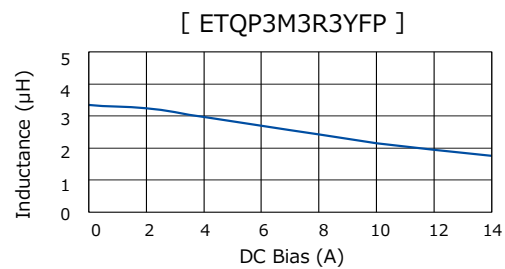
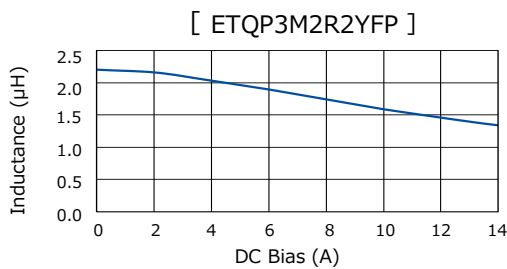

Performance characteristics (Reference②)

● Case Temperature vs DC Current

- PWB condition A : Four-layer PWB (1.6 mm FR4).^{*3}
- - - PWB condition B : Multilayer PWB with high heat dissipation performance.^{*2}

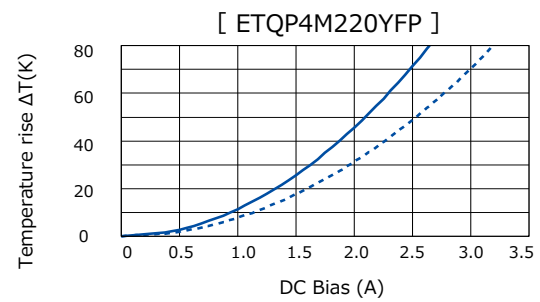
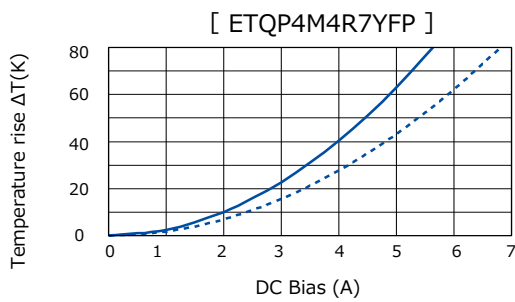
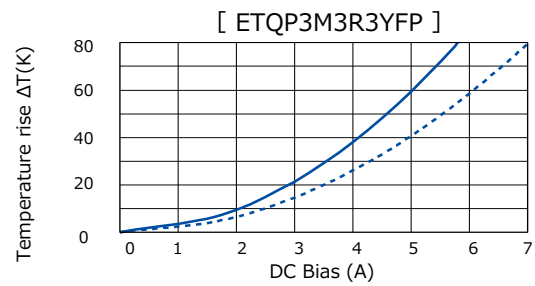
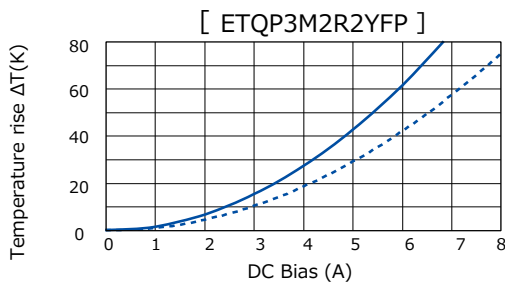

2. Series PCC-M0630M/PCC-M0645M (ETQP3M□□□YFN/ETQP4M□□□YFN)

Standard parts

Part No.	Inductance*1		DCR (at 20 °C) (mΩ)		Rated current (A) Typ.		MSL level *5	Series [Size (mm)]
	L0 (μH)	Tolerance (%)	Typ. (max.)	Tolerance (%)	ΔT= 40 K*2 ()*3	ΔL= -30 %*4		
ETQP3MR68YFN	0.68	±20	6.3 (6.90)	±10	12.0 (9.8)	24.0	1	PCC-M0630M [6.5×6.0×3.0]
ETQP3M1R0YFN	1.0		7.9 (8.70)		10.7 (8.8)	20.0	1	
ETQP4M2R2YFN	2.2		10.4 (11.44)		10.2 (8.0)	14.4	1	
ETQP4M3R3YFN	3.3		16.1 (17.71)		8.2 (6.4)	13.3	1	
ETQP4M6R8YFN	6.8		39.3 (43.20)		5.2 (4.1)	10.0	1	
ETQP4M100YFN	10.0		54.2 (59.60)		4.5 (3.5)	8.3	1	
ETQP4M220YFN	22.0		126.0 (138.60)		2.9 (2.3)	6.0	1	
ETQP4M330YFN	33.0		172.0 (189.20)		2.5 (2.0)	4.1	3	
ETQP4M470YFN	47.0		210.0 (231.00)		2.2 (1.8)	3.8	1	

*1: Measured at 100 kHz

*2: The proved current value for making the overall temperature rise of 40K, when mounted on a multi-layer board with high-heat dissipation (heat dissipation constant 6.5x6.0x3.0 mm : approx. 44 K/W, 6.5x6.0x4.5 mm : approx. 37 K/W).

*3: The proved current value for making the overall temperature rise of 40K, when mounted on a 4-layer circuit board of FR4 t=1.6 mm and DC current is applied.

*4: Saturation rated current : DC current which causes L(0) drop -30 %.

*5: The solderability is guaranteed for 1 year only. The product out of expiration date shall not be used.

◆ Within a suitable application, the part's temperature depends on circuit design and certain heat dissipation conditions. This should be double checked in a worst case operation mode. In normal case, the max.standard operating temperature of +150°C should not be exceeded. For higher operating temperature conditions, please contact Panasonic representative in your area.

Performance characteristics (Reference①)

● Inductance vs DC Current

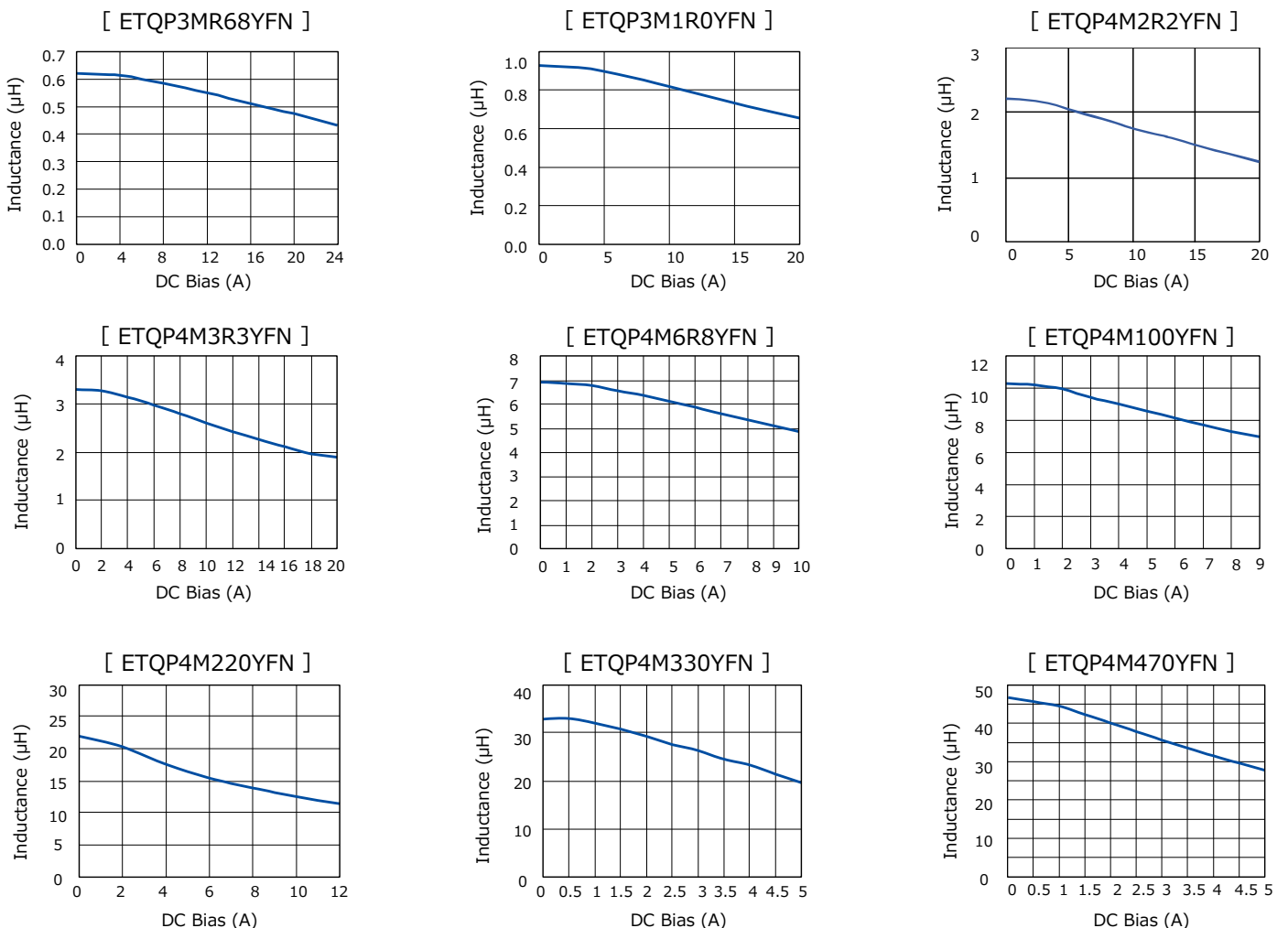

Performance characteristics (Reference②)

● Case Temperature vs DC Current

- PWB condition A : Four-layer PWB (1.6 mm FR4).^{*3}
- - - PWB condition B : Multilayer PWB with high heat dissipation performance.^{*2}

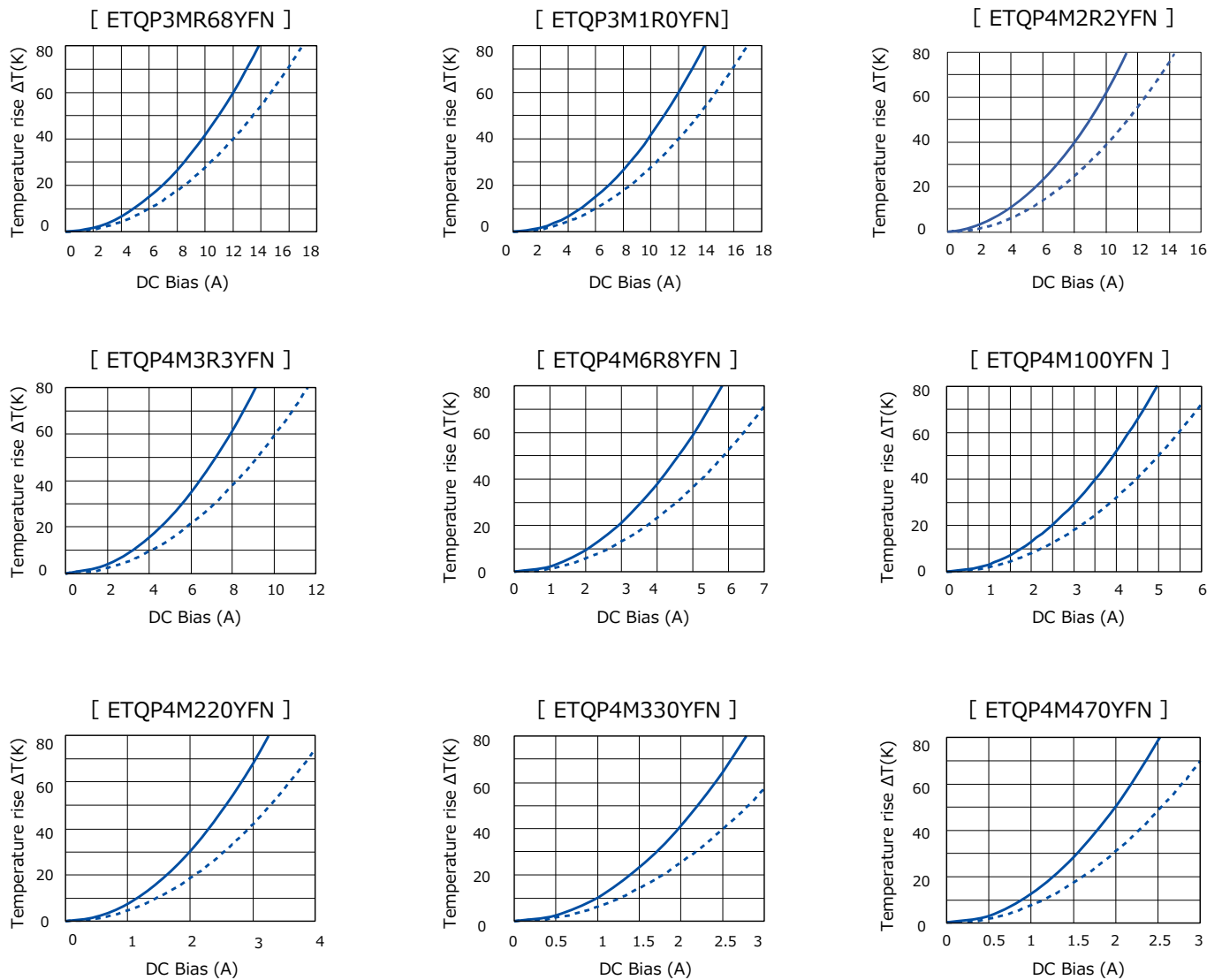

3. Series PCC-M0754M/PCC-M750M (ETQP5M□□□YFM/ETQP5M□□□YGM)

Standard parts

Part No.	Inductance*1		DCR (at 20 °C) (mΩ)		Rated current (A) Typ.		MSL level *5	Series [Size (mm)]
	L0 (μH)	Tolerance (%)	Typ. (max.)	Tolerance (%)	$\Delta T = 40 K^{*2}$ () ^{*3}	$\Delta L = -30 \%^{*4}$		
ETQP5M3R3YFM	3.3	±20	11.9 (13.09)	±10	10.4 (8.3)	14.4	1	PCC-M0754M [7.5×7.0×5.4]
ETQP5M4R7YFM	4.7		20.4 (22.50)		8.0 (6.3)	13.1	1	
ETQP5M6R8YFM	6.8		26.7 (29.40)		6.9 (5.5)	12.1	1	
ETQP5M100YFM	10.0		37.6 (41.30)		5.7 (4.7)	10.6	1	
ETQP5M220YFM	22.0		92.0 (102.00)		3.7 (3.0)	5.8	1	
ETQP5M330YFM	33.0		120.0 (132.00)		3.3 (2.6)	4.8	1	
ETQP5M470YFM	48.0		156.0 (172.00)		2.9 (2.3)	4.1	1	
▲ETQP5M680YFM	68.0		251.0 (276.10)		2.3 (1.8)	3.9	1	
ETQP5M101YGM	95.0		348.0 (382.80)		1.9 (1.4)	3.1	3	PCC-M0750M [7.5×7.0×5.0]

*1: Measured at 100 kHz

▲Underdevelopment

*2: The proved current value for making the overall temperature rise of 40K, when mounted on a multi-layer board with high-heat dissipation (heat dissipation constant 7.5x7.0x5.4 mm : approx. 31 K/W, 7.5x7.0x5.0 mm : approx. 29 K/W).

*3: The proved current value for making the overall temperature rise of 40K, when mounted on a 4-layer circuit board of FR4 t=1.6 mm and DC current is applied.

*4: Saturation rated current : DC current which causes L(0) drop -30 %.

*5: The solderability is guaranteed for 1 year only. The product out of expiration date shall not be used.

◆ Within a suitable application, the part's temperature depends on circuit design and certain heat dissipation conditions. This should be double checked in a worst case operation mode. In normal case, the max.standard operating temperature of +150°C should not be exceeded. For higher operating temperature conditions, please contact Panasonic representative in your area.

Performance characteristics (Reference①)

● Inductance vs DC Current

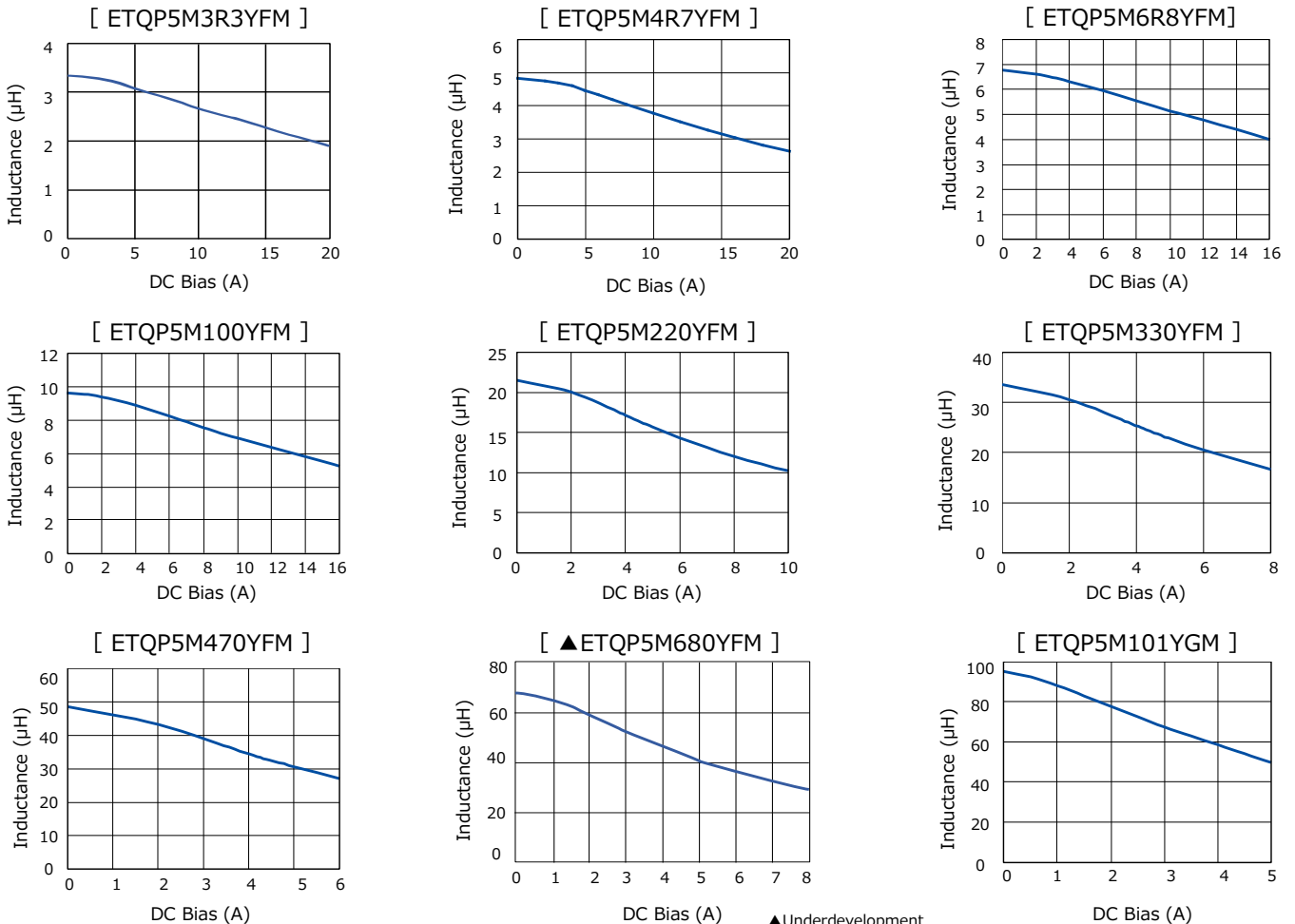

Performance characteristics (Reference②)

● Case Temperature vs DC Current

- PWB condition A : Four-layer PWB (1.6 mm FR4).^{*3}
- - - PWB condition B : Multilayer PWB with high heat dissipation performance.^{*2}

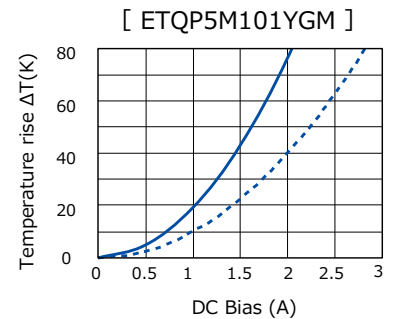
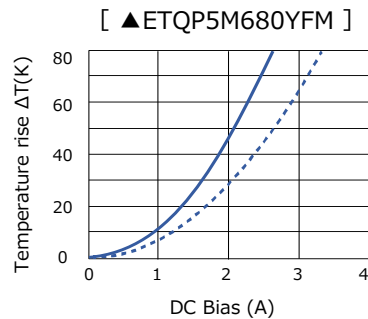
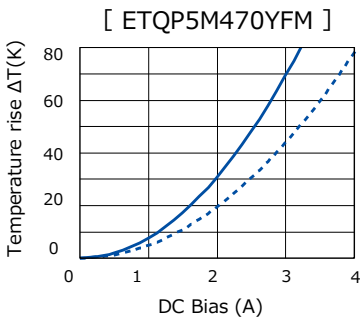
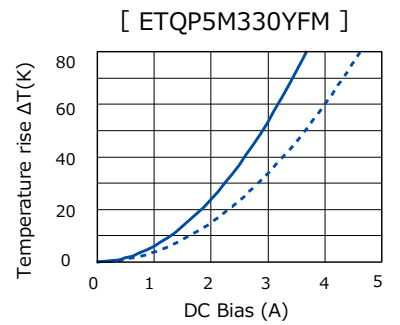
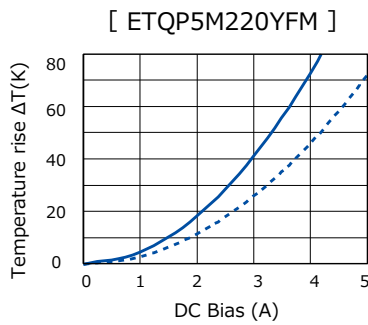
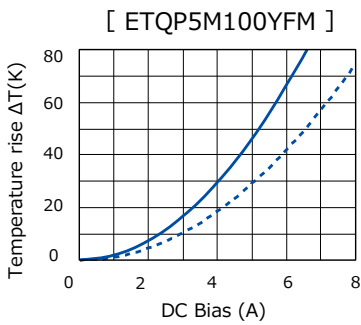
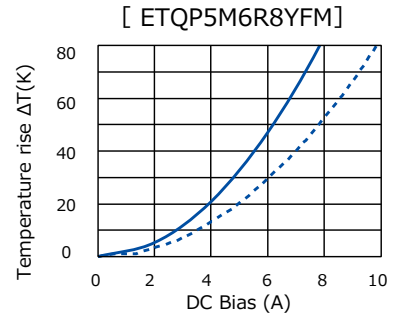
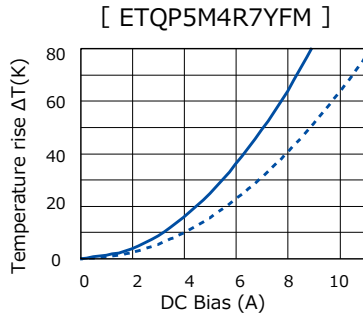
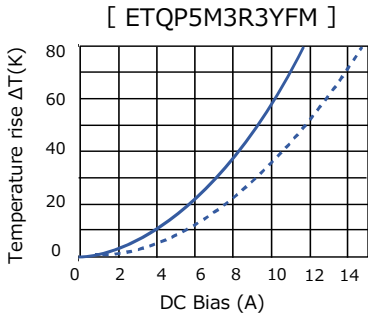

▲Underdevelopment

4. Series PCC-M0854M/PCC-M0850M (ETQP5M□□□YFK/ETQP5M□□□YGK)

Standard parts

Part No.	Inductance *1		DCR (at 20 °C) (mΩ)		Rated current (A) Typ.		MSL level *5	Series [Size (mm)]
	L0 (μH)	Tolerance (%)	Typ. (max.)	Tolerance (%)	$\Delta T = 40 \text{ K}^{*2}$ () ^{*3}	$\Delta L = -30 \%^{*4}$		
ETQP5M2R5YFK	2.5	±20	7.6 (8.40)	±10	14.0 (11.9)	20.1	1	PCC-M0854M [8.5×8.0×5.4]
ETQP5M3R3YFK	3.3		9.5 (10.45)		12.5 (10.7)	17.9	1	
ETQP5M100YFK	10.0		33.4 (36.80)		6.7 (5.7)	13.0	1	
ETQP5M150YFK	15.0		48.2 (53.10)		5.5 (4.7)	7.2	1	
ETQP5M220YFK	22.0		63.0 (70.00)		4.8 (4.1)	6.9	1	
ETQP5M470YFK	48.0		125.0 (138.00)		3.4 (2.9)	5.4	1	
ETQP5M101YGK	100.0		302.0 (333.00)		2.1 (1.7)	3.0	3	PCC-M0850M [8.5×8.0×5.0]

*1: Measured at 100 kHz

*2: The proved current value for making the overall temperature rise of 40K, when mounted on a multi-layer board with high-heat dissipation (heat dissipation constant 8.5x8.0x5.4 mm : approx. 27 K/W, 8.5x8.0x5.0 mm : approx. 29 K/W).

*3: The proved current value for making the overall temperature rise of 40K, when mounted on a 4-layer circuit board of FR4 t=1.6 mm and DC current is applied.

*4: Saturation rated current : DC current which causes L(0) drop -30 %.

*5: The solderability is guaranteed for 1 year only. The product out of expiration date shall not be used.

◆ Within a suitable application, the part's temperature depends on circuit design and certain heat dissipation conditions. This should be double checked in a worst case operation mode. In normal case, the max.standard operating temperature of +150°C should not be exceeded. For higher operating temperature conditions, please contact Panasonic representative in your area.

Performance characteristics (Reference①)

● Inductance vs DC Current

[ETQP5M2R5YFK]

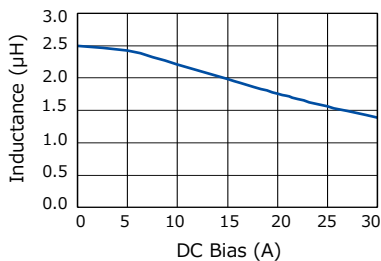

[ETQP5M3R3YFK]

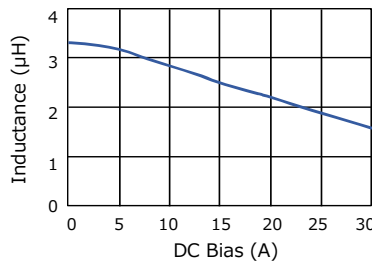

[ETQP5M100YFK]

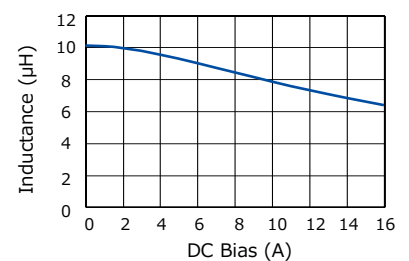

[ETQP5M150YFK]

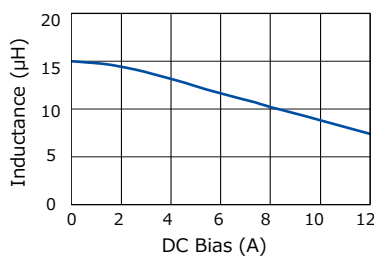

[ETQP5M220YFK]

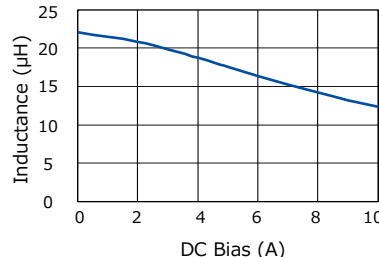

[ETQP5M470YFK]

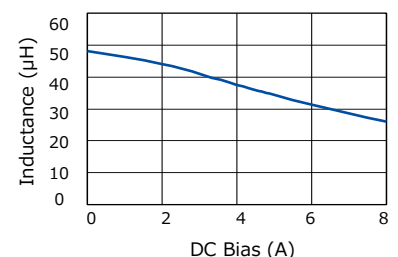

[ETQP5M101YGK]

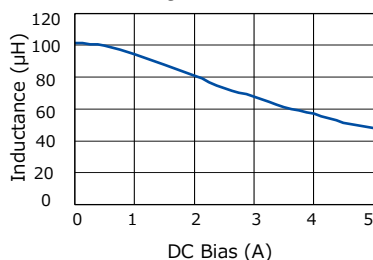

Performance characteristics (Reference②)

● Case Temperature vs DC Current

- PWB condition A : Four-layer PWB (1.6 mm FR4).^{*3}
- - - PWB condition B : Multilayer PWB with high heat dissipation performance.^{*2}

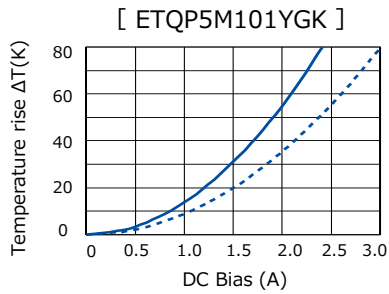
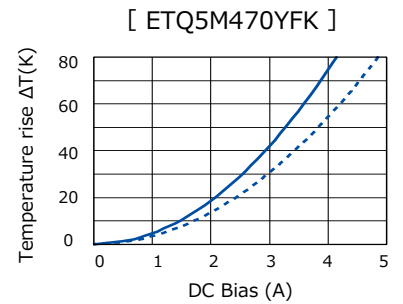
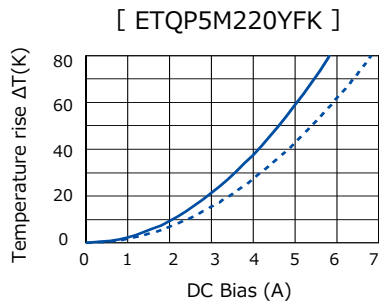
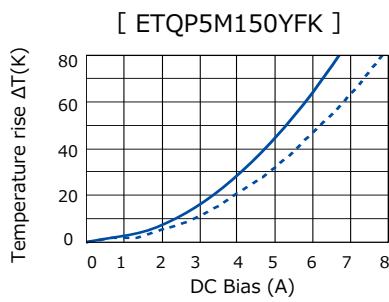
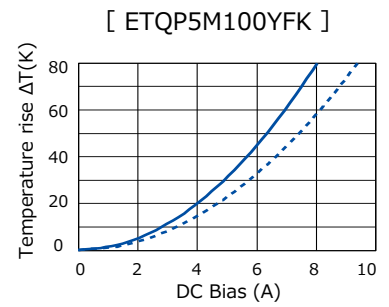
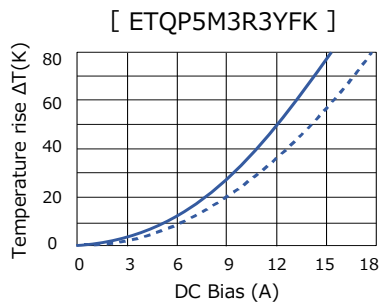
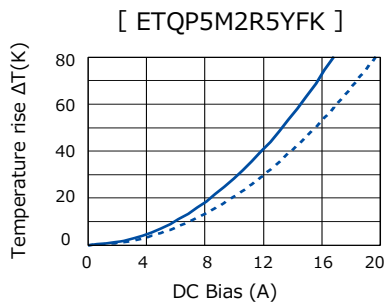

5. Series PCC-M1054M/PCC-M1050M (ETQP5M□□□YFC/ETQP5M□□□YGC)

Standard parts

Part No.	Inductance*1		DCR (at 20 °C) (mΩ)		Rated current (A) Typ.		MSL level *5	Series [Size (mm)]	
	L0 (μH)	Tolerance (%)	Typ. (max.)	Tolerance (%)	$\Delta T = 40 K^{*2}$ () ^{*3}	$\Delta L = -30 \%^{*4}$			
ETQP5M1R5YFC	1.5	±20	3.8 (4.20)		21.4 (17.9)	35.1	1	PCC-M1054M [10.7×10.0×5.4]	
ETQP5M2R5YFC	2.5		5.3 (5.90)		18.1 (15.1)	27.2	1		
ETQP5M3R3YFC	3.3		7.1 (7.90)		15.7 (13.1)	22.7	1		
ETQP5M4R7YFC	4.7		10.2 (11.30)		13.1 (10.9)	20.0	1		
ETQP5M100YFC	10.0		23.8 (26.20)		8.5 (7.1)	10.7	1		
ETQP5M150YFC	15.0		35.6 (39.16)		7.0 (5.8)	12.0	1		
ETQP5M220YFC	22.0		45.0 (50.00)		6.2 (5.2)	8.8	1		
ETQP5M330YFC	33.0		68.5 (75.40)		5.0 (4.2)	7.6	1		
ETQP5M470YFC	47.0		99.0 (108.90)		4.2 (3.5)	6.8	1		
ETQP5M680YFC	66.0		136.0 (149.60)		3.6 (3.0)	4.9	1		
ETQP5M3R3YGC	3.3		7.1 (7.81)		14.7 (11.8)	23.4	1		PCC-M1050M [10.7×10.0×5.0]
ETQP5M101YGC	97.0		208.0 (229.00)		2.7 (2.2)	3.0	3		

*1: Measured at 100 kHz

*2: The proved current value for making the overall temperature rise of 40K, when mounted on a multi-layer board with high-heat dissipation (heat dissipation constant 10.7×10.0×5.4 mm : approx. 23 K/W, 10.7×10.0×5.0 mm : approx. 26 K/W).

*3: The proved current value for making the overall temperature rise of 40K, when mounted on a 4-layer circuit board of FR4 t=1.6 mm and DC current is applied.

*4: Saturation rated current : DC current which causes L(0) drop -30 %.

*5: The solderability is guaranteed for 1 year only. The product out of expiration date shall not be used.

◆ Within a suitable application, the part's temperature depends on circuit design and certain heat dissipation conditions. This should be double checked in a worst case operation mode. In normal case, the max.standard operating temperature of +150°C should not be exceeded. For higher operating temperature conditions, please contact Panasonic representative in your area.

Performance characteristics (Reference①)

● Inductance vs DC Current

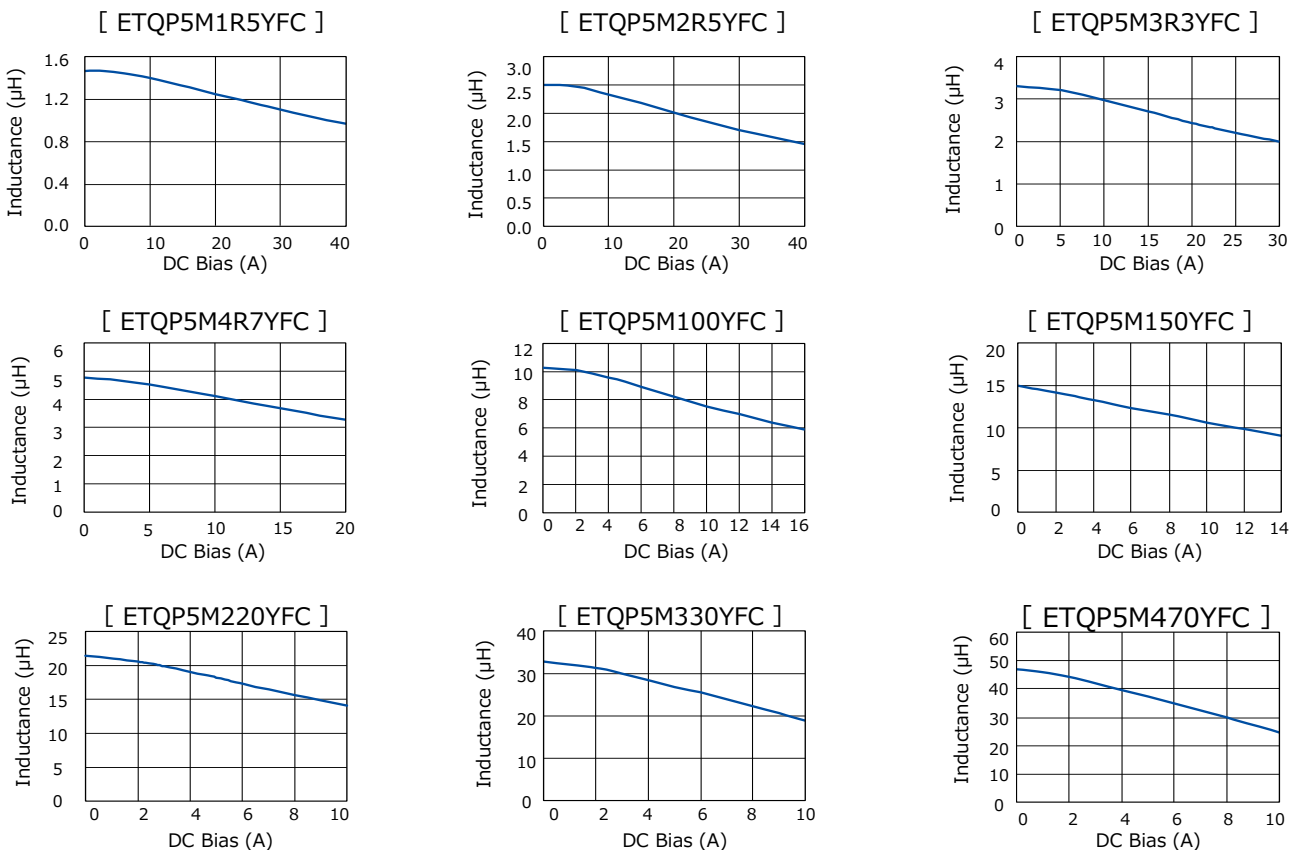

Performance characteristics (Reference①)

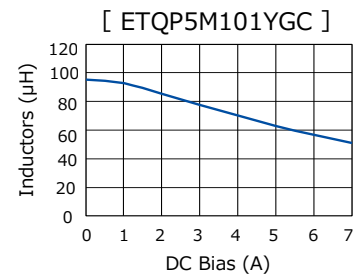
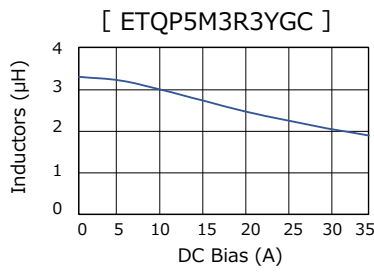
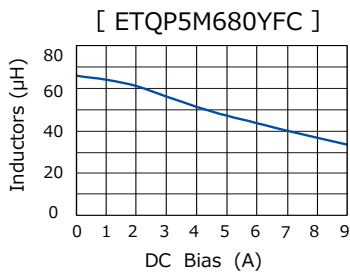

Performance characteristics (Reference②)

● Case Temperature vs DC Current

- PWB condition A : Four-layer PWB (1.6 mm FR4).*3
- - - PWB condition B : Multilayer PWB with high heat dissipation performance.*2

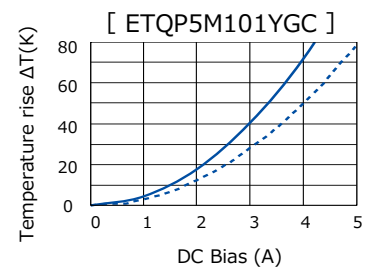
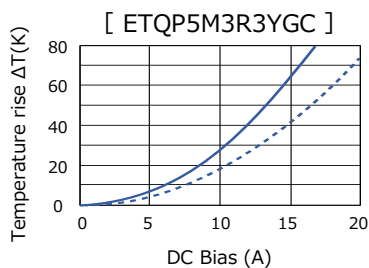
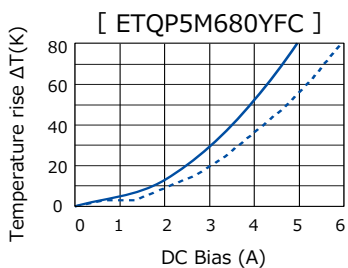
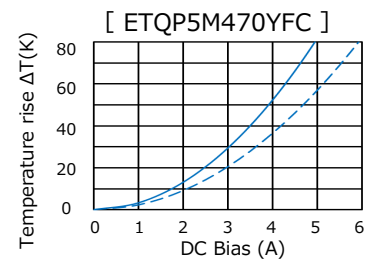
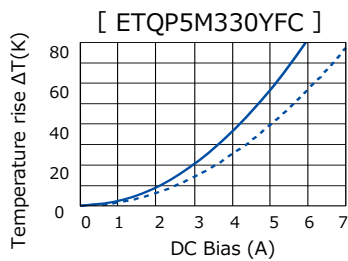
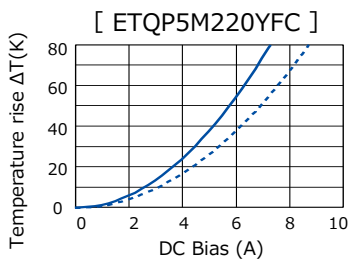
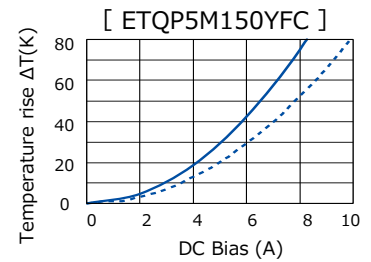
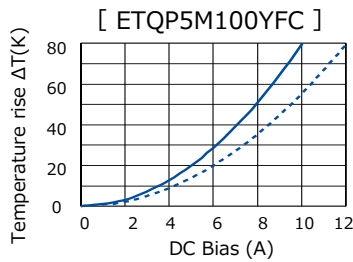
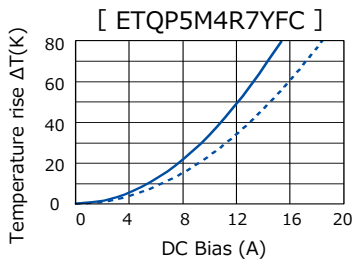
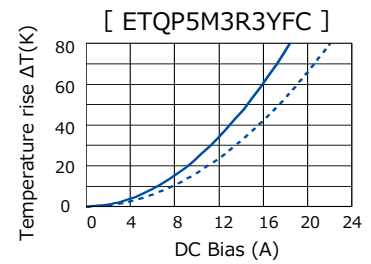
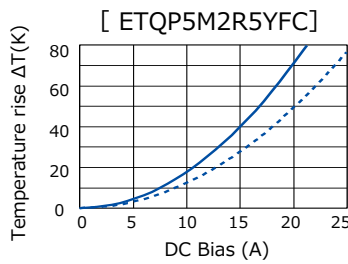
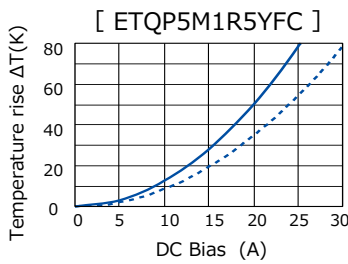

6. Series PCC-M1050ML/PCC-M1060ML (ETQP5M□□□YLC/ETQP6M□□□YLC/KLC)

Standard parts

Part No.	Inductance *1		DCR (at 20 °C) (mΩ)		Rated current (A) Typ.		MSL level *5	Series [Size (mm)]	
	L0 (μH)	Tolerance (%)	Typ. (max.)	Tolerance (%)	ΔT= 40 K*2 ()*3	ΔL= -30 %*4			
ETQP5MR33YLC	0.33	±20	1.1 (1.21)	±10	39.7 (33.2)	56.7	1	PCC-M1050ML [10.9×10.0×5.0]	
ETQP5MR68YLC	0.68		1.75 (1.93)		31.5 (26.3)	40.0	1		
ETQP5M1R0YLC	1.0		2.3 (2.53)		27.5 (23.0)	37.8	1		
ETQP5M2R0YLC	2.0		4.6 (5.06)		19.4 (16.2)	31.3	1		
ETQP6M1R5YLC	1.5		3.2 (3.52)		23.3 (19.5)	32.0	1		PCC-M1060ML [10.9×10.0×6.0]
ETQP6M2R5YLC	2.5		4.55 (5.00)		19.6 (16.3)	25.8	1		
ETQP6M3R3YLC	3.3		6.0 (6.60)		17.0 (14.2)	26.3	1		
ETQP6M4R7YLC	4.7		8.7 (9.57)		14.1 (11.8)	22.5	1		
NEW ETQP6M150KLC	14.0	28.0 (30.80)	7.9(6.5)	11.2	1				

*1: Measured at 100 kHz

*2: The proved current value for making the overall temperature rise of 40K, when mounted on a multi-layer board with high-heat dissipation (heat dissipation constant 10.9x10.0x5.0 mm : approx. 23 K/W, 10.9x10.0x6.0 mm : approx. 23 K/W).

*3: The proved current value for making the overall temperature rise of 40K, when mounted on a 4-layer circuit board of FR4 t=1.6 mm and DC current is applied.

*4: Saturation rated current : DC current which causes L(0) drop -30 %.

*5: The solderability is guaranteed for 1 year only. The product out of expiration date shall not be used.

◆ Within a suitable application, the part's temperature depends on circuit design and certain heat dissipation conditions. This should be double checked in a worst case operation mode. In normal case, the max.standard operating temperature of +150°C should not be exceeded. For higher operating temperature conditions, please contact Panasonic representative in your area.

Performance characteristics (Reference①)

● Inductance vs DC Current

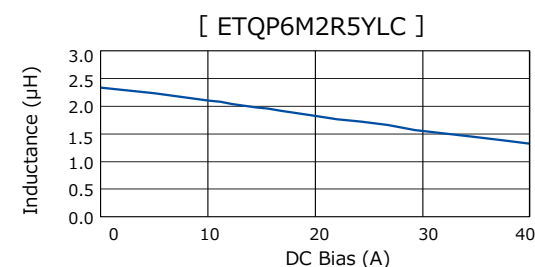
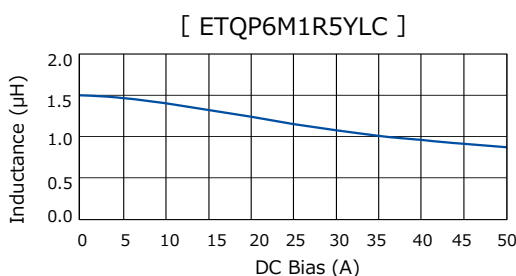
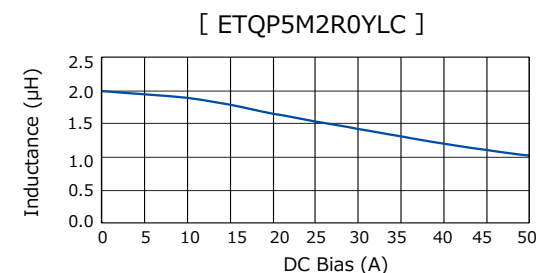
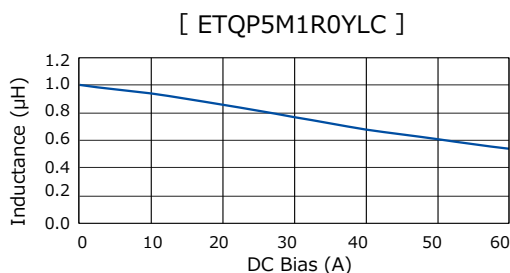
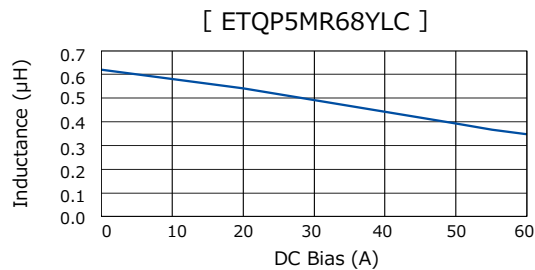
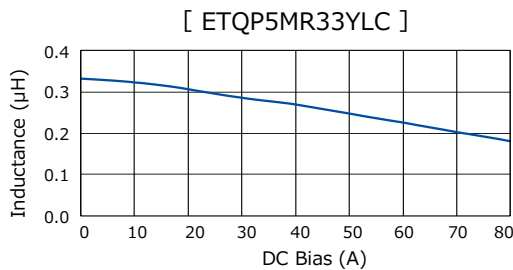

Performance characteristics (Reference①)

[ETQP6M3R3YLC]

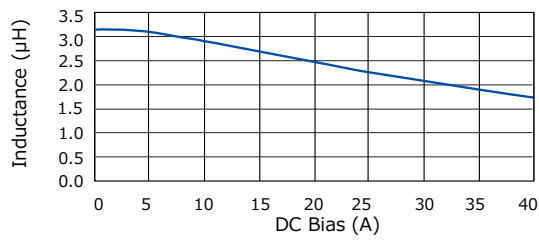

[ETQP6M4R7YLC]

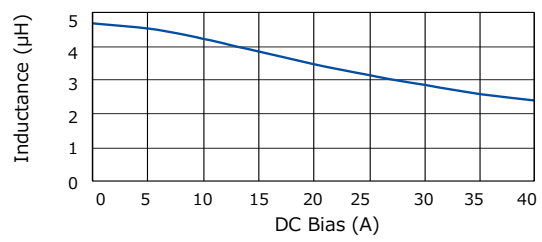

[ETQP6M150KLC]

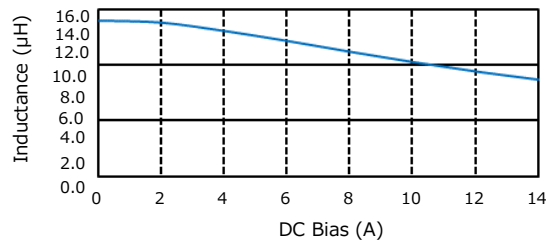

Performance characteristics (Reference②)

● Case Temperature vs DC Current

- PWB condition A : Four-layer PWB (1.6 mm FR4).^{*3}
- - - PWB condition B : Multilayer PWB with high heat dissipation performance.^{*2}

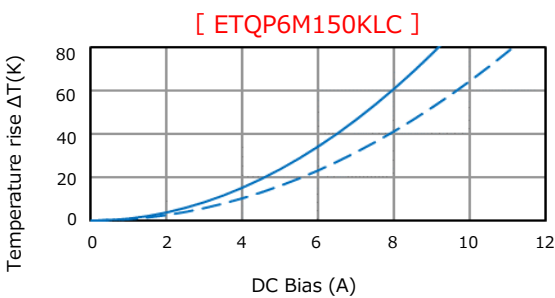
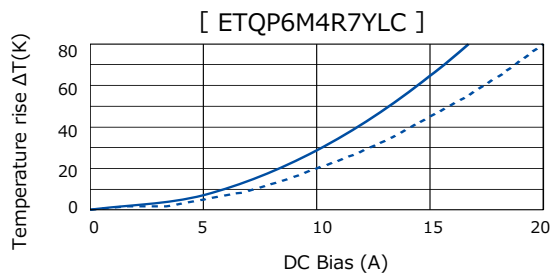
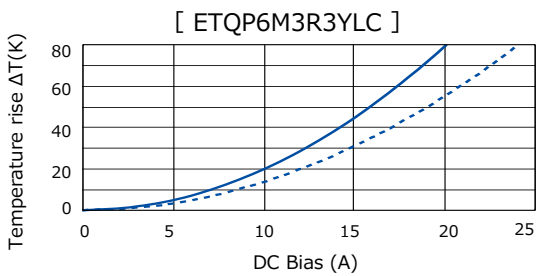
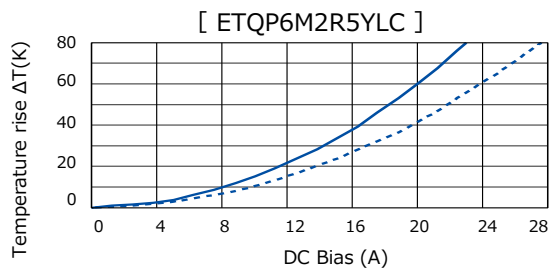
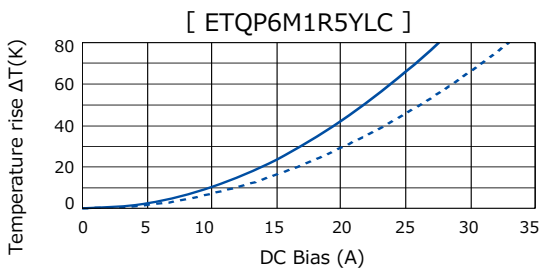
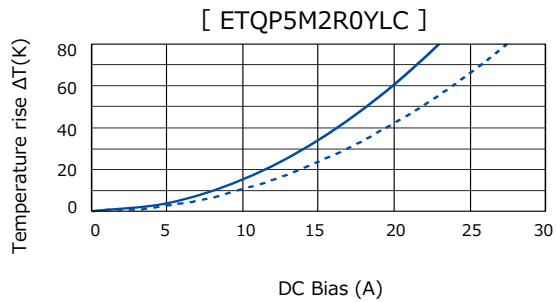
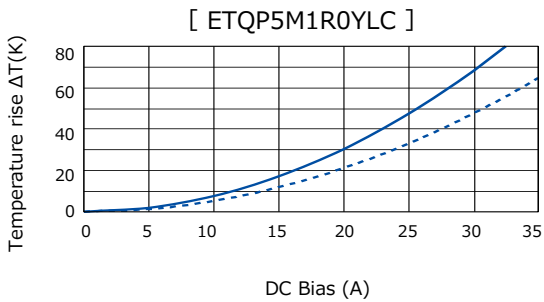
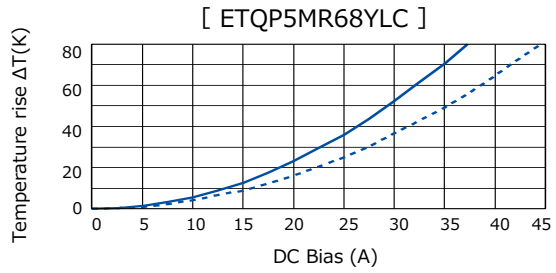
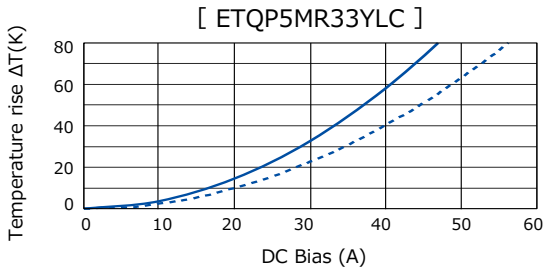

Dimensions in mm (not to scale)

Dimensional tolerance unless noted : ± 0.5

Series PCC-M0530M
Series PCC-M0540M
 (ETQP3M□□□YFP/ETQP4M□□□YFP)

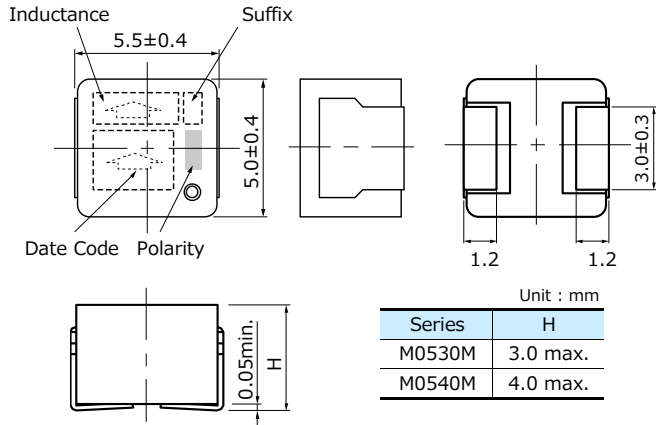

Series PCC-M0630M
Series PCC-M0645M
 (ETQP3M□□□YFN/ETQP4M□□□YFN)

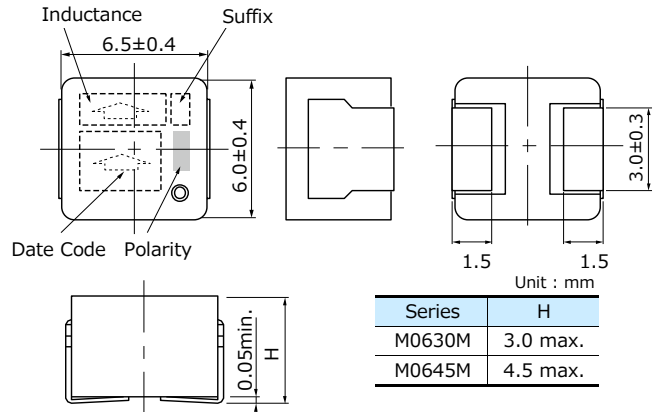

Series PCC-M0754M
Series PCC-M0750M
 (ETQP5M□□□YFM/YGM)

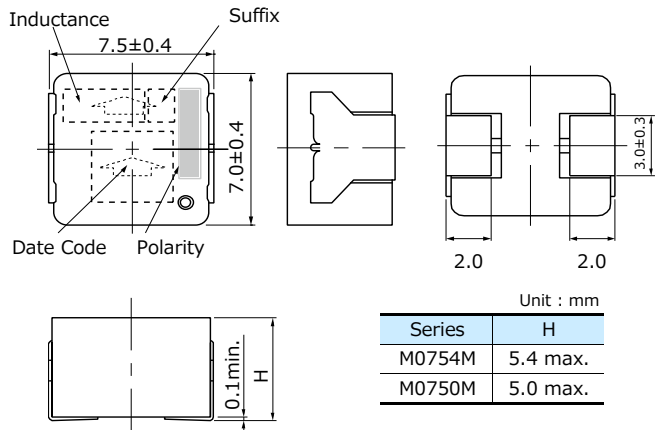

Series PCC-M0854M
Series PCC-M0850M
 (ETQP5M□□□YFK/YGK)

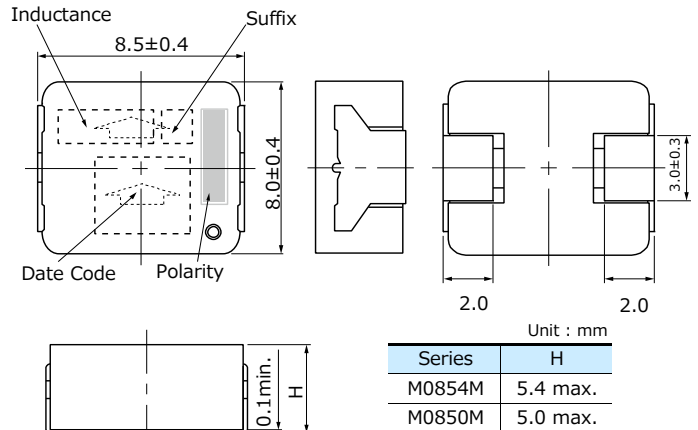

Series PCC-M1054M
Series PCC-M1050M
 (ETQP5M□□□YFC/YGC)

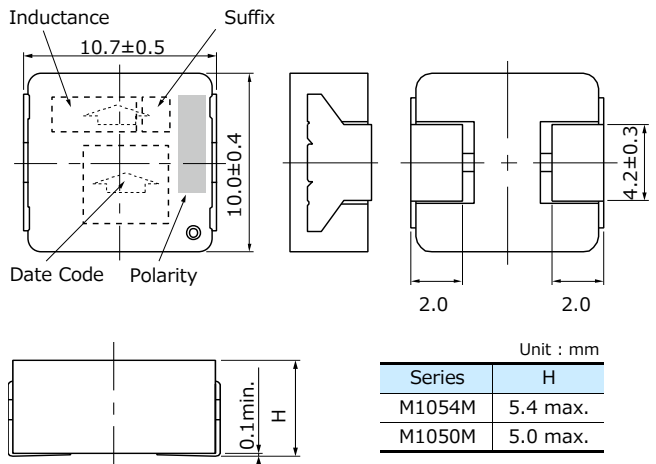

Series PCC-M1050ML
Series PCC-M1060ML
 (ETQP5M□□□YLC/ETQP6M□□□YLC/KLC)

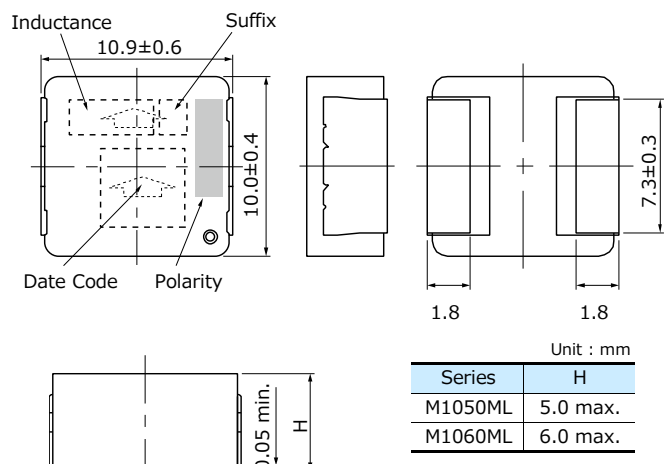

Recommended land pattern in mm (not to scale)

Dimensional tolerance unless noted : ±0.5

Series PCC-M0530M
Series PCC-M0540M
 (ETQP3M□□□YFP/ETQP4M□□□YFP)

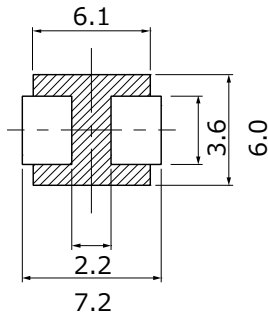

Series PCC-M0630M
Series PCC-M0645M
 (ETQP3M□□□YFN/ETQP4M□□□YFN)

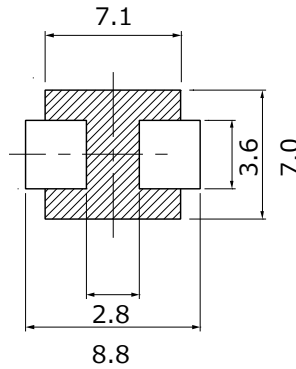

Series PCC-M0754M
Series PCC-M0750M
 (ETQP5M□□□YFM/YGM)

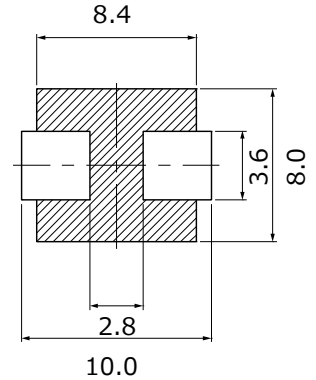

Series PCC-M0854M
Series PCC-M0850M
 (ETQP5M□□□YFK/YGK)

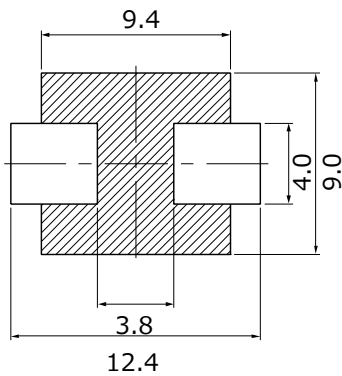

Series PCC-M1054M
Series PCC-M1050M
 (ETQP5M□□□YFC/YGC)

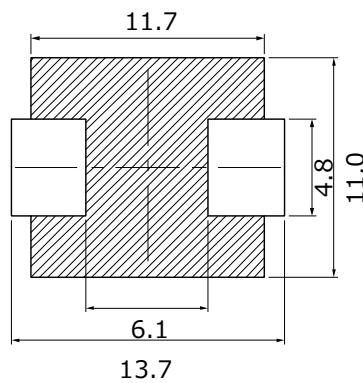

Series PCC-M1050ML
Series PCC-M1060ML
 (ETQP5M□□□YLC/ETQP6M□□□YLC/KLC)

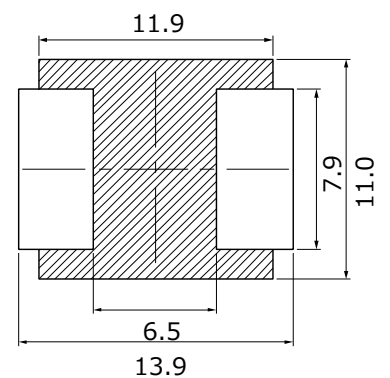

※Don't wire on the pattern on shaded portion the PWB.

Unit : mm

■ As for soldering conditions and safety precautions (Power choke coils (Automotive grade)), please see data files

Packaging methods (Taping)

● Embossed carrier tape

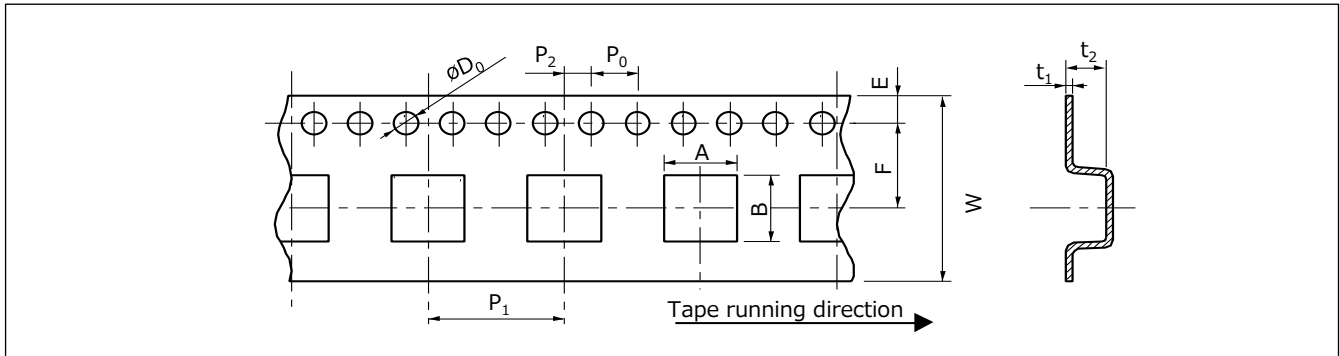

Series	A	B	W	E	F	P ₁	P ₂	P ₀	øD ₀	t ₁	t ₂				
PCC-M0530M	5.6	6.1	16.0	1.75	7.5	12.0	2.0	4.0	1.5	0.4	3.3				
PCC-M0540M											4.3				
PCC-M0630M	7.1	6.6									24.0	11.5	16.0	0.5	6.35
PCC-M0645M															
PCC-M0754M/M0750M	8.1	7.6													
PCC-M0854M/M0850M	9.1	8.6													
PCC-M1054M/M1050M	10.65	11.75													
PCC-M1050ML/M1060ML															

Unit : mm

● Taping reel

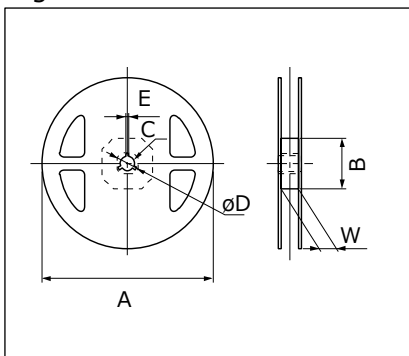

Series	A	B	C	øD	E	W
PCC-M0530M/M0540M	330	100	13	21	2	17.5
PCC-M0630M/M0645M						
PCC-M0754M/M0750M						
PCC-M0854M/M0850M						
PCC-M1054M/M1050M						25.5
PCC-M1050ML/M1060ML						

Unit : mm

Component placement (Taping)

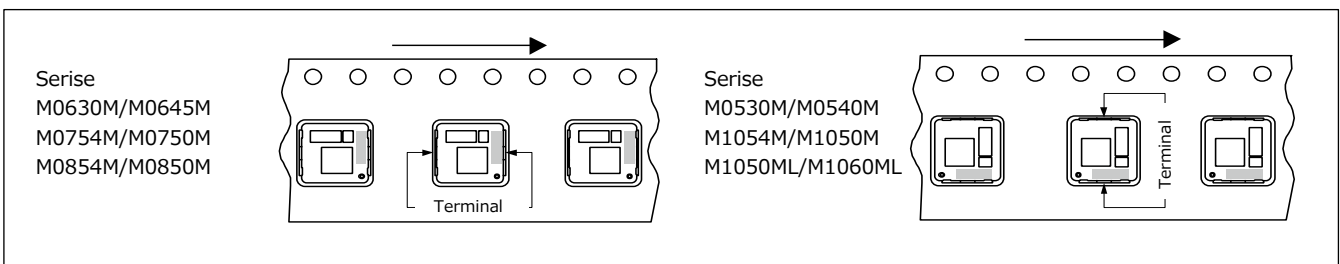

Standard packing quantity/reel

Series	Part No.	Minimum quantity / Packing unit	Quantity per reel
PCC-M0530M	ETQP3M□□□YFP	2,000 pcs / box (2 reel)	1,000 pcs
PCC-M0540M	ETQP4M□□□YFP		
PCC-M0630M	ETQP3M□□□YFN	1,000 pcs / box (2 reel)	500 pcs
PCC-M0645M	ETQP4M□□□YFN		
PCC-M0754M	ETQP5M□□□YFM		
PCC-M0750M	ETQP5M□□□YGM		
PCC-M0854M	ETQP5M□□□YFK		
PCC-M0850M	ETQP5M□□□YGK		
PCC-M1054M	ETQP5M□□□YFC		
PCC-M1050M	ETQP5M□□□YGC		
PCC-M1050ML	ETQP5M□□□YLC		
PCC-M1060ML	ETQP6M□□□YLC/KLC		

Design and specifications are each subject to change without notice. Ask factory for the current technical specifications before purchase and/or use. Should a safety concern arise regarding this product, please be sure to contact us immediately.

Guidelines and precautions regarding the technical information and use of our products described in this online catalog.

- If you want to use our products described in this online catalog for applications requiring special qualities or reliability, or for applications where the failure or malfunction of the products may directly jeopardize human life or potentially cause personal injury (e.g. aircraft and aerospace equipment, traffic and transportation equipment, combustion equipment, medical equipment, accident prevention, anti-crime equipment, and/or safety equipment), it is necessary to verify whether the specifications of our products fit to such applications. Please ensure that you will ask and check with our inquiry desk as to whether the specifications of our products fit to such applications use before you use our products.
- The quality and performance of our products as described in this online catalog only apply to our products when used in isolation. Therefore, please ensure you evaluate and verify our products under the specific circumstances in which our products are assembled in your own products and in which our products will actually be used.
- If you use our products in equipment that requires a high degree of reliability, regardless of the application, it is recommended that you set up protection circuits and redundancy circuits in order to ensure safety of your equipment.
- The products and product specifications described in this online catalog are subject to change for improvement without prior notice. Therefore, please be sure to request and confirm the latest product specifications which explain the specifications of our products in detail, before you finalize the design of your applications, purchase, or use our products.
- The technical information in this online catalog provides examples of our products' typical operations and application circuits. We do not guarantee the non-infringement of third party's intellectual property rights and we do not grant any license, right, or interest in our intellectual property.
- If any of our products, product specifications and/or technical information in this online catalog is to be exported or provided to non-residents, the laws and regulations of the exporting country, especially with regard to security and export control, shall be observed.

<Regarding the Certificate of Compliance with the EU RoHS Directive/REACH Regulations>

- The switchover date for compliance with the RoHS Directive/REACH Regulations varies depending on the part number or series of our products.
- When you use the inventory of our products for which it is unclear whether those products are compliant with the RoHS Directive/REACH Regulation, please select "Sales Inquiry" in the website inquiry form and contact us.

We do not take any responsibility for the use of our products outside the scope of the specifications, descriptions, guidelines and precautions described in this online catalog.

Safety Precautions

(Common precautions for Power Choke Coils (Automotive Grade) : Series DUST, Series MC)

- When using our products, no matter what sort of equipment they might be used for, be sure to make a written agreement on the specifications with us in advance. The design and specifications in this catalog are subject to change without prior notice.
- Do not use the products beyond the specifications described in this catalog.
- This catalog explains the quality and performance of the products as individual components. Before use, check and evaluate their operations when installed in your products.
- Install the following systems for a failsafe design to ensure safety if these products are to be used in equipment where a defect in these products may cause the loss of human life or other significant damage, such as damage to vehicles (automobile, train, vessel), traffic lights, medical equipment, aerospace equipment, electric heating appliances, combustion/gas equipment, rotating equipment, and disaster/crime prevention equipment.
- * Systems equipped with a protection circuit and a protection device.
- * Systems equipped with a redundant circuit or other system to prevent an unsafe status in the event of a single fault.

■ Precautions for use

1. Provision to abnormal condition

This power choke coil itself does not have any protective function in abnormal condition such as overload, short-circuit and open-circuit conditions, etc.

Therefore, it shall be confirmed as the end product that there is no risk of smoking, fire, dielectric withstand voltage, insulation resistance, etc. in abnormal conditions to provide protective devices and/or protection circuit in the end product.

2. Temperature rise

Temperature rise of power choke coil depends on the installation condition in end products. It shall be confirmed in the actual end product that temperature rise of power choke coil is in the limit of specified temperature class.

3. Dielectric strength

Dielectric withstanding test with higher voltage than specific value will damage Insulating material and shorten its life.

4. Water

This Power choke coil must not be used in wet condition by water, coffee or any liquid because insulation strength becomes very low in such condition.

5. Potting

If this power choke coil is potted in some compound, coating material of magnet wire might be occasionally damaged. Please ask us if you intend to pot this power choke coil.

6. Model

When this power choke coil is used in a similar or new product to the original one, it might be unable to satisfy the specifications due to difference of condition of usage.

Please ask us if you use this power choke coil in the manner such as above.

7. Drop

If the power choke coil receives mechanical stress such as drop, characteristics may become poor (due to damage on coil bobbin, etc.). Never use such stressed power choke coil.

8. Buzz Noise

When this coil is used in the frequency band of the audible range (\cong 20 Hz to 20 kHz), or, when using in burst mode, depending on the operating conditions (conditions of the energized waveform) sounds (buzz noise) may occur. Depending on the circuit / board installation environment it may be heard as abnormal sounds, so please check in advance.

9. Solvent (Series MC)

If this power choke coil is dipped in the cleaning agent, and the coating agent of the toluene and the xylene system, there is a possibility that the performance decreases greatly. Please ask us if you intend to pot this power choke coil.

10. Static electricity measures (Series MC)

①Circuit design

Please set up the ESD measures parts such as capacitors in the former steps of this power choke coil for static electricity when there is a possibility that static electricity is impressed to the choke coil on the circuit.

Moreover, please consult our company about such a case once.

② Treatment with single

Take countermeasures against static electricity when using single power choke coil. (process and equipment)
There is a possibility that the characteristic changes when the voltage of 200 V or more is impressed to this power choke coil. Please handle 200 V or less.

11. Printed circuit board design

- ① Land pattern and Via which exceed Operating Voltage, should not be placed top layer PWB under the products for keeping isolation between inside coil and surface of PWB. (Series DUST)
- ② To the opposing part in this power choke coil bottom please install neither pattern nor the beer, etc. (Series MC)

The opposing part in the choke coil bottom

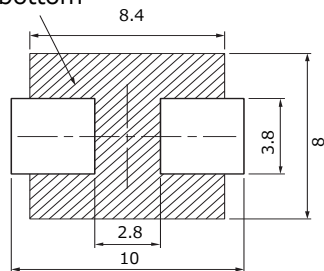

- ③ Parts arranged around this power choke coil do not touch the surface of this power choke coil (Top side and side). (Series MC)

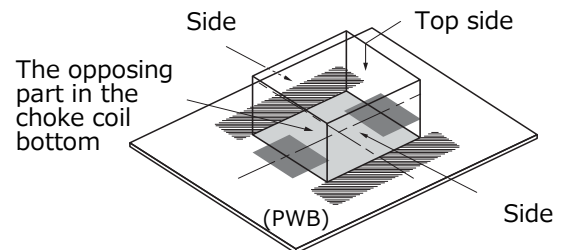

- ④ This power choke coil is different from the ferrite core-type that installs general concentration GAP. It has the leakage magnetic bunch distribution of the choke coil to the vertical direction. Please be cautious when using parts and circuit compositions which are easily affected by the leakage flux.

12. Other using environment

This power choke coil is not designed for the use in the following, special environment.

Therefore, please do not use it in the following special environment.

- Use in place where a lot of causticity gases such as sea breeze, Cl_2 , H_2S , NH_3 , SO_2 , and NO_x exist.
- Use in place where out-of-door exposure and direct sunshine strike.

13. Core Chipping and Core Crack

This choke coil has a possibility to make partial chipping or crack in the core due to excessive mechanical stress from outside, and might have initially a partial chipping and/or cracks that do not affect the quality.

14. Keeping environment

If this power choke coil is kept under following environment and condition, there is a possibility that the performance and soldering decreases greatly.

- Keep in place where a lot of causticity gases such as sea breeze, Cl_2 , H_2S , NH_3 , SO_2 , and NO_x exist.
- Keep in place where out-of-door exposure and direct sunshine strike.

■ AEC-Q200 Compliant

The products are tested based on all or part of the test conditions and methods defined in AEC-Q200. Please consult with Panasonic for the details of the product specification and specific evaluation test results, etc., and please review and approve Panasonic's product specification before ordering.

<Package markings>

Package markings include the product number, quantity, and country of origin.

In principle, the country of origin should be indicated in English.