

CGJ3E2C0G2A121J080AA

TDK Item Description : CGJ3E2C0G2A121JT***



Application & Main Feature

High Reliability Grade (Mid Voltage (100 to 630V))

Series

CGJ3(1608) [EIA CC0603]

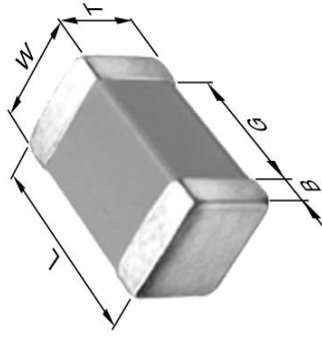

Dimensions

L	1.60mm	+/-0.1mm
W	0.80mm	+/-0.1mm
T	0.80mm	+/-0.1mm
B	0.20mm	Min.
G	0.30mm	Min.

Temperature Characteristic

C0G (-55 to 125 degC 0+/-30ppm/degC)

Rated Voltage

2A (100Vdc)

Capacitance

120pF

Capacitance Tolerance

J (+/-5%)

Q Factor

1000 Min.

Insulation Resistance

10Gohm Min.

AEC-Q200

Yes

|Z|, ESR vs. Freq. Characteristics

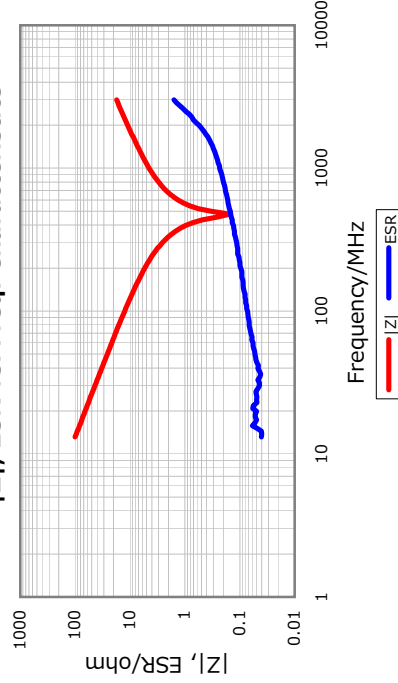

DC Bias Characteristic

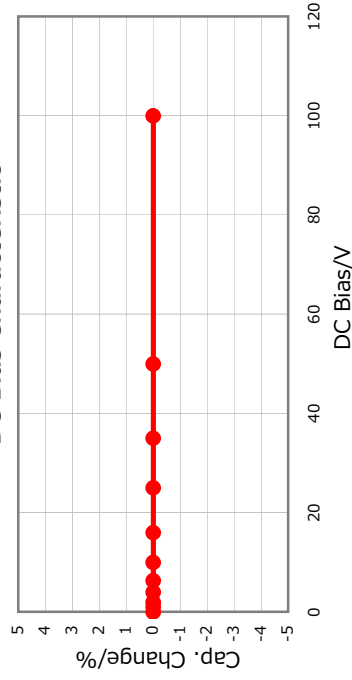

Cap. vs. Freq. Characteristic

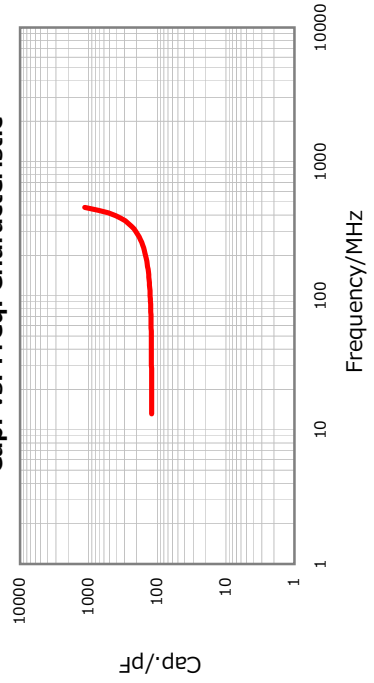

Temperature Characteristics

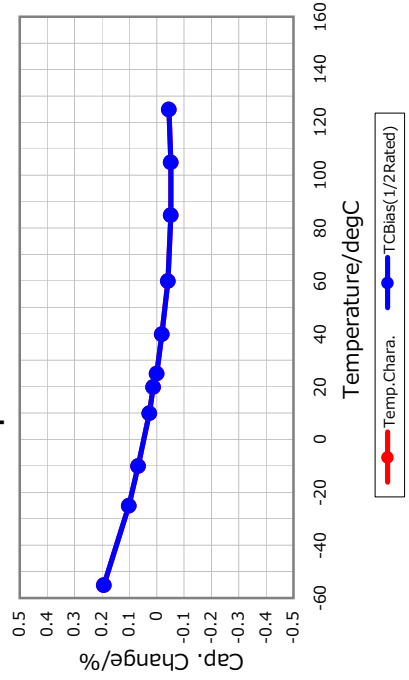

⚠ All specifications are subject to change without notice.

January 4, 2016