

# C3216CH2J821K085AA

TDK Item Description : C3216CH2J821KT\*\*\*\*



## Application & Main Feature

Commercial Grade ( Mid Voltage (100 to 630V) )

## Series

C3216 [EIA CC1206]

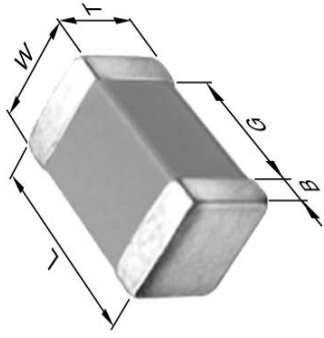

## Dimensions

L	3.20mm	+/-0.2mm
W	1.60mm	+/-0.2mm
T	0.85mm	+/-0.15mm
B	0.20mm	Min.
G	1.00mm	Min.

## Temperature Characteristic

CH (-25 to 85 degC 0+/-60ppm/degC)

## Rated Voltage

2J (630Vdc)

## Capacitance

820pF

## Capacitance Tolerance

K (+/-10%)

## Q Factor

1000 Min.

## Insulation Resistance

10Gohm Min.

## AEC-Q200

Not Applicable

## |Z|, ESR vs. Freq. Characteristics

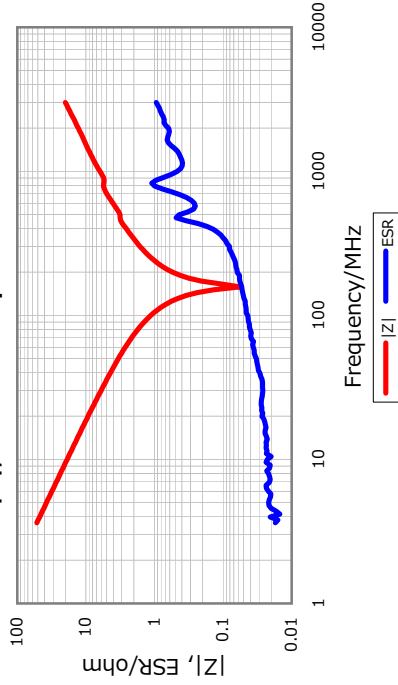

## DC Bias Characteristic

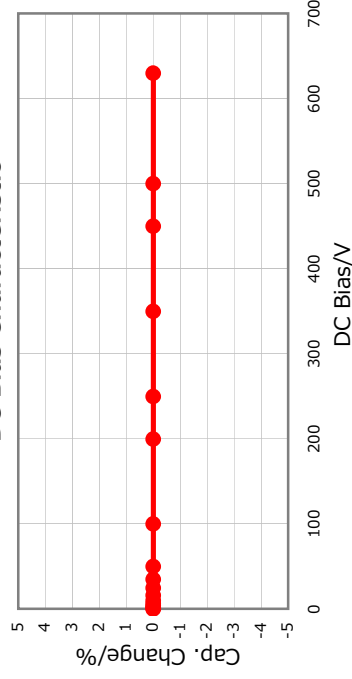

## Cap. vs. Freq. Characteristic

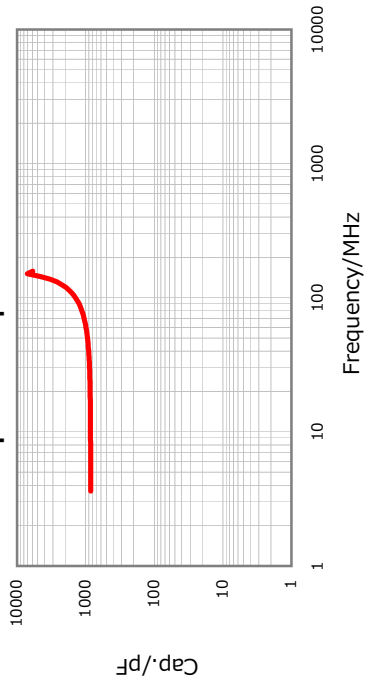

## Temperature Characteristics

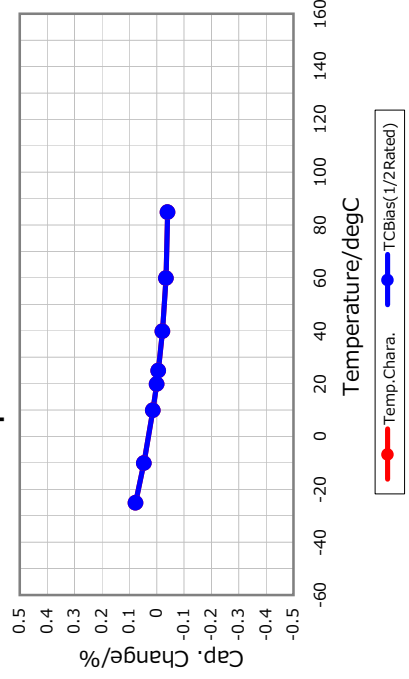

⚠ All specifications are subject to change without notice.

January 3, 2016