

65V, 2A Micropower Synchronous Monolithic Step-Down Regulator

DESCRIPTION

Demonstration circuit 1992A is a 65V, 2A micropower synchronous monolithic step-down regulator featuring the LT[®]8620. The LT8620 is a compact, high efficiency, high speed synchronous monolithic step-down switching regulator that consumes only 2.5 μ A of quiescent current when output is regulated at 5V. Top and bottom power switches, compensation components and other necessary circuits are inside of the LT8620 to minimize external components and simplify design.

The SYNC pin on the demo board is grounded by default for low ripple Burst Mode[®] operation. To synchronous to an external clock, move JP1 to SYNC and apply the external clock to the SYNC turret. Once JP1 is on SYNC position, a DC voltage of higher than 2V or INTV_{CC} can be applied to the SYNC turret pulse skipping operation. Figure 1 shows the efficiency of the circuit at 12V input.

The demo board has an EMI filter installed. The board and the IC are designed to minimize conducted and radiated EMI. The radiated EMI performances of the board are shown on Figure 2 to Figure 4. The limits on those figures are CISPR25, Class 5 peak limits. It shows the circuit passes the test with a wide margin.

The LT8620 data sheet gives a complete description of the part, operation and application information. The data sheet must be read in conjunction with this quick start guide for demo circuit 1992A.

Design files for this circuit board are available at <http://www.linear.com/demo/DC1992A>

LT, LT, LTC, LTM, Linear Technology, Burst Mode and the Linear logo are registered trademarks of Linear Technology Corporation. All other trademarks are the property of their respective owners.

PERFORMANCE SUMMARY Specifications are at T_A = 25°C

SYMBOL	PARAMETER	CONDITIONS	MIN	TYP	MAX	UNITS
V _{IN}	Input Supply Range		5.5		65	V
V _{OUT}	Output Voltage		4.8	5	5.2	V
I _{OUT}	Maximum Output Current		2			A
f _{SW}	Switching Frequency		1.85	2	2.15	MHz
EFE	Efficiency at DC	I _{OUT} = 1A		92		%

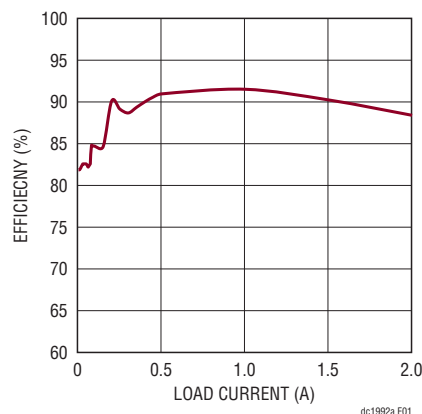

Figure 1. LT8620 12V_{IN} to 5V_{OUT} Efficiency at 2MHz Switching Frequency

DESCRIPTION

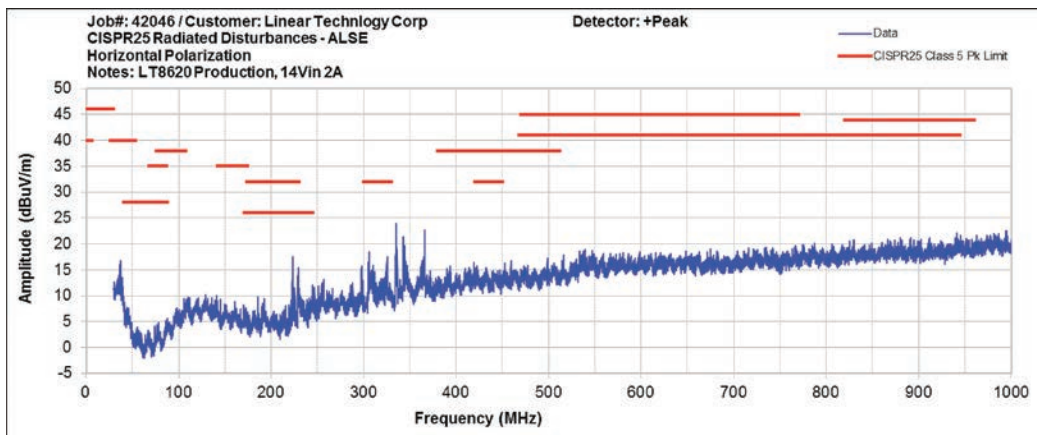

Figure 2. 30MHz to 1GHz Radiated EMI Performance. $V_{IN} = 12V$, $V_{OUT} = 5V$, $I_{OUT} = 2A$
Antenna Polarization: Horizontal; Switching Frequency: 2MHz

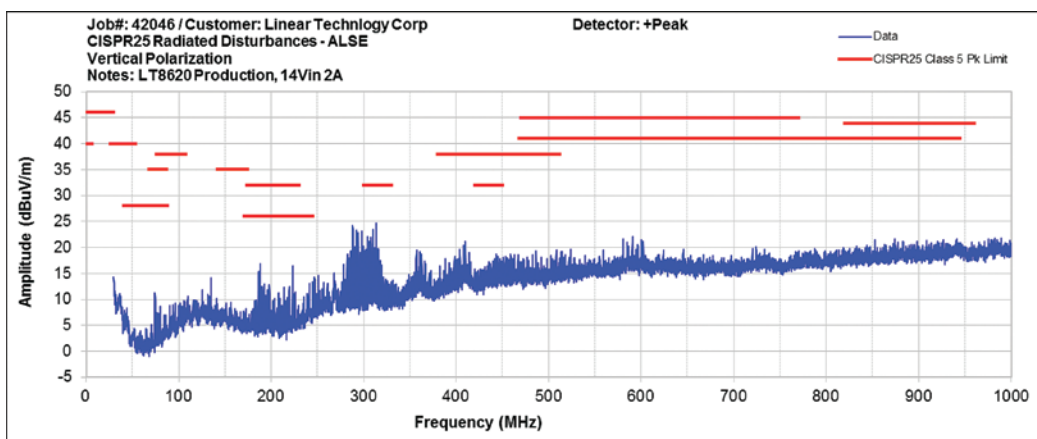

Figure 3. 30MHz to 1GHz Radiated EMI Performance. $V_{IN} = 12V$, $V_{OUT} = 5V$, $I_{OUT} = 2A$
Antenna Polarization: Vertical; Switching Frequency: 2MHz

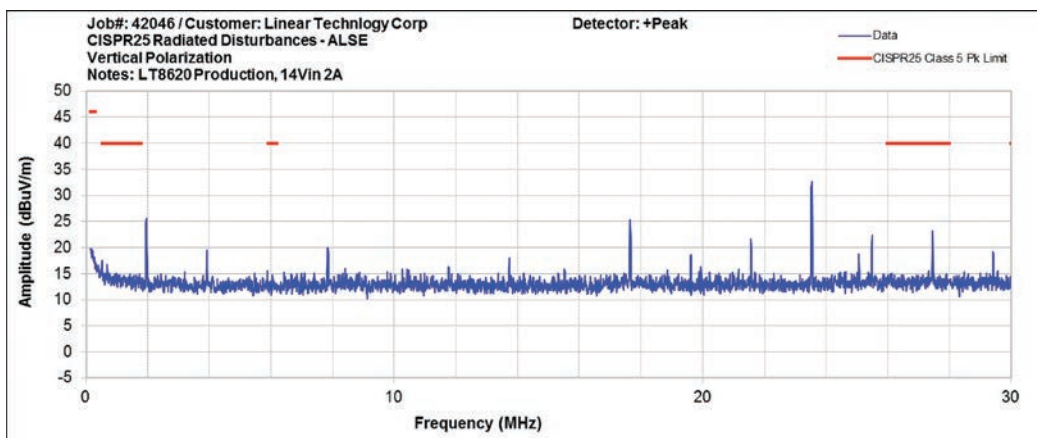

Figure 4. 150kHz to 30MHz Radiated EMI Performance. $V_{IN} = 12V$, $V_{OUT} = 5V$, $I_{OUT} = 2A$
Antenna Polarization: Vertical; Switching Frequency: 2MHz
(In the Frequency Range Between 150kHz and 30MHz, Only Vertical Polarization Is Required)

QUICK START PROCEDURE

Demonstration circuit 1992A is easy to set up to evaluate the performance of the LT8620. Refer to Figure 5 and Figure 6 for proper measurement equipment setup and follow the procedure below:

1. With power off, connect the input power supply to V_{IN} and GND.

2. With power off, connect the load V_{OUT} and GND.

3. Check JP1 setting

4. Turn on the power at the input.

5. Carefully evaluate other design parameters as needed.

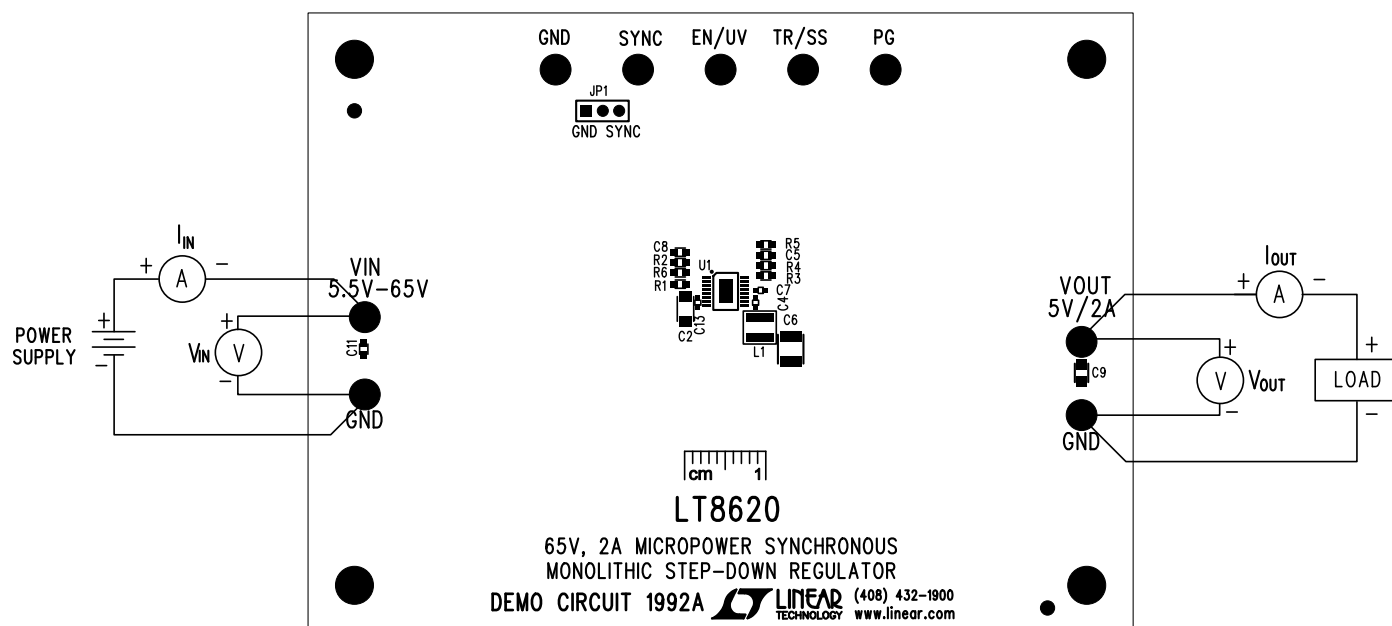

Figure 5. Proper Measurement Equipment Setup

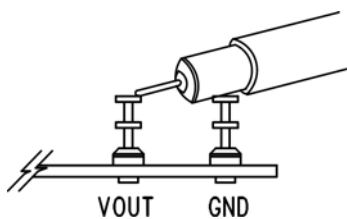

Figure 6. Measure Output Ripple

DEMO MANUAL DC1992A

PARTS LIST

ITEM	QTY	REFERENCE	PART DESCRIPTION	MANUFACTURER/PART NUMBER
Required Circuit Components				
1	1	C2	CAP., X7R, 2.2 μ F, 100V, 10%, 1206	MURATA, GRM31CR72A225K
2	1	C4	CAP., X7R, 0.1 μ F, 16V, 10%, 0402	MURATA, GRM155R71C104KA88D
3	1	C5	CAP., COG, 10pF, 25V, 10%, 0603	AVX, 06033A100KAT2A
4	1	C6	CAP., X7R, 47 μ F, 10V, 10%, 1210	MURATA, GRM32ER71A476KE2015L
5	1	C7	CAP., X5R, 1.0 μ F, 10V, 10%, 0402	MURATA, GRM155R61A105K
6	1	C8	CAP., X7R, 0.1 μ F, 16V, 10%, 0603	MURATA, GRM188R71C104K
7	1	L1	IND, 2.2 μ H XFL4020	COILCRAFT, XFL4020-222MEC
8	1	R2	RES., CHIP, 18.2k, 1/10W, 1%, 0603	VISHAY, CRCW060318K2FKED
9	1	R3	RES., CHIP, 49.9k, 1/16W, 1%, 0603	VISHAY, CRCW060349K9FKED
10	2	R1, R4	RES., CHIP, 1M, 1/16W, 1%, 0603	VISHAY, CRCW06031M00FKED
11	1	R5	RES., CHIP, 243k, 1/16W, 1%, 0603	VISHAY, CRCW0603243KFKED
12	1	U1	IC, LT8620EMSE, MSE16	LINEAR TECH. CORP., LT8620EMSE#PBF
Additional Demo Board Circuit Components				
1	1	C1	CAP., ALUM, 10 μ F, 100V	SUN ELECT, 100CE10BS
2	2	C3, C10	CAP., X7S, 4.7 μ F, 100V, 10%, 1210	TDK, C3225X7S2A475K
3	1	C9	CAP., X7R, 1.0 μ F, 16V, 10%, 0805	AVX, 0805YC105KAT2A
4	2	C11, C12	CAP., X7R, 0.1 μ F, 100V, 10%, 0603	MURATA, GRM188R72A104K
5	1	C13	CAP., X5R, 0.1 μ F, 100V, 10%, 0402	MURATA, GRM155R62A104K
6	1	FB1	FERRITE BEAD 0805	TDK, MPZ2012S221A
7	1	L2	IND, 4.7 μ H IHLP2020BZ-01	VISHAY, IHLP2020BZ-ER4R7M01
8	0	R6 (OPT)	RES., 0603	
Hardware: For Demo Board Only				
1	9	E1-E9	TESTPOINT, TURRET, 0.094" PBF	MILL-MAX, 2501-2-00-80-00-00-07-0
2	1	JP1	3 PIN 0.079" SINGLE ROW HEADER	SULLIN, NRPN031PAEN-RC
3	1	XJP1	SHUNT, 0.079" CENTER	SAMTEC, 2SN-BK-G
4	4	MH1-MH4	STAND-OFF, NYLON 0.50" TALL	KEYSTONE, 8833(SNAP ON)

SCHEMATIC DIAGRAM

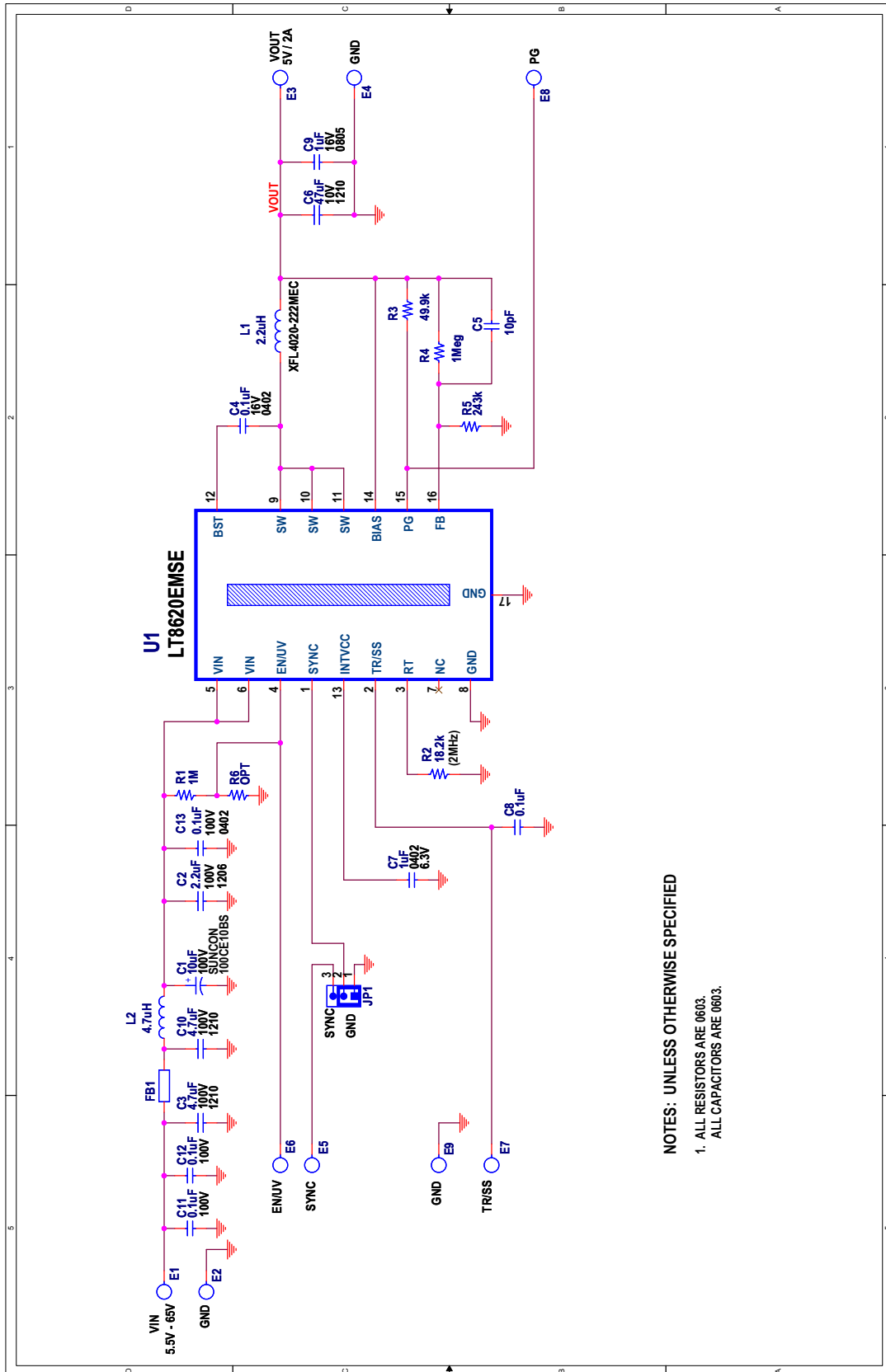

NOTES: UNLESS OTHERWISE SPECIFIED

- 1. ALL RESISTORS ARE 0603.
- ALL CAPACITORS ARE 0603.

DEMO MANUAL DC1992A

DEMONSTRATION BOARD IMPORTANT NOTICE

Linear Technology Corporation (LTC) provides the enclosed product(s) under the following **AS IS** conditions:

This demonstration board (DEMO BOARD) kit being sold or provided by Linear Technology is intended for use for **ENGINEERING DEVELOPMENT OR EVALUATION PURPOSES ONLY** and is not provided by LTC for commercial use. As such, the DEMO BOARD herein may not be complete in terms of required design-, marketing-, and/or manufacturing-related protective considerations, including but not limited to product safety measures typically found in finished commercial goods. As a prototype, this product does not fall within the scope of the European Union directive on electromagnetic compatibility and therefore may or may not meet the technical requirements of the directive, or other regulations.

If this evaluation kit does not meet the specifications recited in the DEMO BOARD manual the kit may be returned within 30 days from the date of delivery for a full refund. **THE FOREGOING WARRANTY IS THE EXCLUSIVE WARRANTY MADE BY THE SELLER TO BUYER AND IS IN LIEU OF ALL OTHER WARRANTIES, EXPRESSED, IMPLIED, OR STATUTORY, INCLUDING ANY WARRANTY OF MERCHANTABILITY OR FITNESS FOR ANY PARTICULAR PURPOSE. EXCEPT TO THE EXTENT OF THIS INDEMNITY, NEITHER PARTY SHALL BE LIABLE TO THE OTHER FOR ANY INDIRECT, SPECIAL, INCIDENTAL, OR CONSEQUENTIAL DAMAGES.**

The user assumes all responsibility and liability for proper and safe handling of the goods. Further, the user releases LTC from all claims arising from the handling or use of the goods. Due to the open construction of the product, it is the user's responsibility to take any and all appropriate precautions with regard to electrostatic discharge. Also be aware that the products herein may not be regulatory compliant or agency certified (FCC, UL, CE, etc.).

No License is granted under any patent right or other intellectual property whatsoever. **LTC assumes no liability for applications assistance, customer product design, software performance, or infringement of patents or any other intellectual property rights of any kind.**

LTC currently services a variety of customers for products around the world, and therefore this transaction **is not exclusive**.

Please read the DEMO BOARD manual prior to handling the product. Persons handling this product must have electronics training and observe good laboratory practice standards. **Common sense is encouraged.**

This notice contains important safety information about temperatures and voltages. For further safety concerns, please contact a LTC application engineer.

Mailing Address:

Linear Technology
1630 McCarthy Blvd.
Milpitas, CA 95035

Copyright © 2004, Linear Technology Corporation