

FEATURES

- Low power: as low as 35 μ A in measurement mode and 0.1 μ A in standby mode at $V_S = 2.5$ V**
- Power consumption scales automatically with bandwidth**
- Embedded, 32-level FIFO buffer minimizes processor load**
- 3 dB bandwidth of up to 1.6 kHz**
- Bandwidth selectable via serial command**
- Shock event detection**
- Activity/inactivity monitoring**
- Supply voltage range: 2.0 V to 3.6 V**
- I/O voltage range: 1.7 V to V_S**
- SPI (3- or 4-wire) and I²C digital interfaces**
- 10,000 g shock survival**
- Pb free/RoHS compliant**
- Small and thin: 3 mm \times 5 mm \times 1 mm LGA package**

ENHANCED PRODUCT FEATURES

- Supports defense and aerospace applications (AQEC standard)**
- Extended industrial temperature range: -55°C to +105°C**
- Controlled manufacturing baseline**
- 1 assembly/test site**
- 1 fabrication site**
- Product change notification**
- Qualification data available on request**

APPLICATIONS

- Concussion and head trauma detection**
- High force event detection**

GENERAL DESCRIPTION

The ADXL375-EP is a small, thin, 3-axis accelerometer that provides low power consumption and high resolution measurement up to ± 200 g. The digital output data is formatted as 16-bit, two's complement data and is accessible through a serial peripheral interface (SPI) (3- or 4-wire) or I²C digital interface.

An integrated memory management system with a 32-level first in, first out (FIFO) buffer can be used to store data to minimize host processor activity and lower overall system power consumption.

Low power modes enable intelligent motion-based power management with threshold sensing and active acceleration measurement at extremely low power dissipation.

The ADXL375-EP is supplied in a small, thin, 3 mm \times 5 mm \times 1 mm, 14-terminal land grid array (LGA).

Additional application and technical information can be found in the [ADXL375](#) data sheet.

FUNCTIONAL BLOCK DIAGRAM

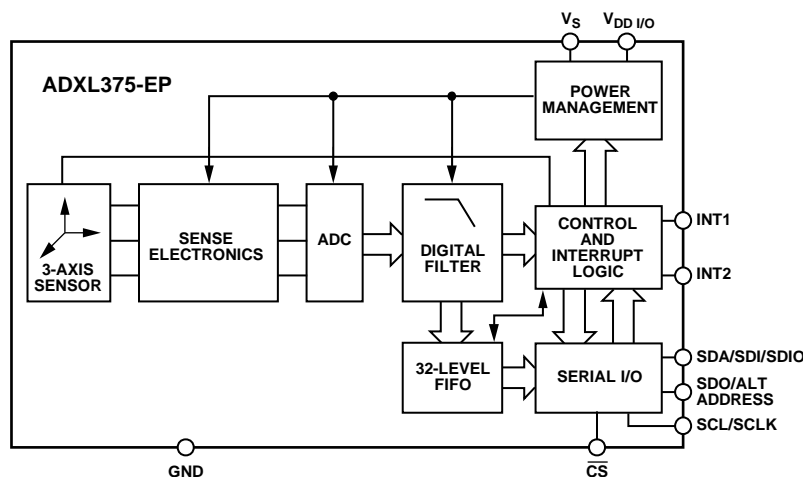

Figure 1.

Rev. 0

[Document Feedback](#)

Information furnished by Analog Devices is believed to be accurate and reliable. However, no responsibility is assumed by Analog Devices for its use, nor for any infringements of patents or other rights of third parties that may result from its use. Specifications subject to change without notice. No license is granted by implication or otherwise under any patent or patent rights of Analog Devices. Trademarks and registered trademarks are the property of their respective owners.

One Technology Way, P.O. Box 9106, Norwood, MA 02062-9106, U.S.A.
Tel: 781.329.4700 ©2018 Analog Devices, Inc. All rights reserved.
[Technical Support](#) www.analog.com

TABLE OF CONTENTS

Features	1	Thermal Resistance	4
Enhanced Product Features	1	ESD Caution.....	4
Applications.....	1	Pin Configuration and Function Descriptions.....	5
General Description	1	Typical Performance Characteristics	6
Functional Block Diagram	1	Outline Dimensions	7
Revision History	2	Ordering Guide	7
Specifications.....	3		
Absolute Maximum Ratings.....	4		

REVISION HISTORY

7/2018—Revision 0: Initial Version

SPECIFICATIONS

$T_A = 25^\circ\text{C}$, $V_S = 2.5\text{ V}$, $V_{DDI/O} = 2.5\text{ V}$, acceleration = 0 g, $C_S = 10\ \mu\text{F}$ tantalum, $C_{I/O} = 0.1\ \mu\text{F}$, and output data rate (ODR) = 800 Hz, unless otherwise noted.

Table 1.

Parameter	Test Conditions/Comments	Min	Typ ¹	Max	Unit
SENSOR INPUT					
Measurement Range ²	Each axis	±180	±200		g
Nonlinearity	Percentage of full scale		±0.25		%
Cross-Axis Sensitivity ³			±2.5		%
SENSITIVITY					
Sensitivity at X_{OUT} , Y_{OUT} , Z_{OUT} ^{2, 4}	Each axis ODR ≤ 800 Hz	18.4	20.5	22.6	LSB/g
Scale Factor at X_{OUT} , Y_{OUT} , Z_{OUT} ^{2, 4}	ODR ≤ 800 Hz	44	49	54	mg/LSB
Sensitivity Change Due to Temperature			±0.02		%/°C
0 g OFFSET					
0 g Output for X_{OUT} , Y_{OUT} , Z_{OUT}	Each axis	-6000	±400	+6000	mg
0 g Offset vs. Temperature			±10		mg/°C
NOISE					
	X-, y-, and z-axes		5		mg/√Hz
OUTPUT DATA RATE AND BANDWIDTH⁵					
Output Data Rate (ODR) ^{4, 6}	User selectable	0.1		3200	Hz
SELF-TEST⁷					
Output Change in Z-Axis			6.4		g
POWER SUPPLY					
Operating Voltage Range (V_S)		2.0	2.5	3.6	V
Interface Voltage Range ($V_{DDI/O}$)		1.7	1.8	V_S	V
Supply Current					
Measurement Mode	ODR ≥ 100 Hz		145		μA
	ODR ≤ 3 Hz		35		μA
Standby Mode			0.1		μA
Turn-On and Wake-Up Time ⁸	ODR = 3200 Hz		1.4		ms
TEMPERATURE					
Operating Temperature Range		-55		+105	°C
WEIGHT					
Device Weight			30		mg

¹ Typical specifications are for at least 68% of the population of devices and are based on the worst case of mean ± 1 σ distribution, except for sensitivity, which represents the target value.

² Minimum and maximum specifications represent the worst case of mean ± 3 σ distribution and are not guaranteed in production.

³ Cross axis sensitivity is defined as coupling between any two axes.

⁴ The output format for the 1600 Hz and 3200 Hz output data rates is different from the output format for the other output data rates. For more information, see the [ADXL375](#) data sheet.

⁵ Bandwidth is the -3 dB frequency and is half the output data rate: bandwidth = ODR/2.

⁶ Output data rates < 6.25 Hz exhibit additional offset shift with increased temperature.

⁷ Self test change is defined as the output (g) when the SELF_TEST bit = 1 (DATA_FORMAT register, Address 0x31) minus the output (g) when the SELF_TEST bit = 0. Due to device filtering, the output reaches its final value after $4 \times \tau$ when enabling or disabling self test, where $\tau = 1/(\text{data rate})$. For the self test to operate correctly, the part must be in normal power operation (LOW_POWER bit = 0 in the BW_RATE register, Address 0x2C).

⁸ Turn on and wake-up times are determined by the user defined bandwidth. At a 100 Hz data rate, the turn on and wake-up times are each approximately 11.1 ms. For other data rates, the turn on and wake-up times are each approximately $\tau + 1.1\text{ ms}$, where $\tau = 1/(\text{data rate})$.

ABSOLUTE MAXIMUM RATINGS

Table 2.

Parameter	Rating
Acceleration, Any Axis	
Unpowered	10,000 g
Powered	10,000 g
V_S	-0.3 V to +3.9 V
$V_{DD I/O}$	-0.3 V to +3.9 V
Digital Pins	-0.3 V to $V_{DD I/O} + 0.3$ V or 3.9 V, whichever is less
Output Short-Circuit Duration (Any Pin to Ground)	Indefinite
Temperature Range	
Powered	-55°C to +105°C
Storage	-65°C to +150°C

Stresses at or above those listed under Absolute Maximum Ratings may cause permanent damage to the product. This is a stress rating only; functional operation of the product at these or any other conditions above those indicated in the operational section of this specification is not implied. Operation beyond the maximum operating conditions for extended periods may affect product reliability.

THERMAL RESISTANCE

Thermal performance is directly linked to printed circuit board (PCB) design and operating environment. Careful attention to PCB thermal design is required.

θ_{JA} is the natural convection, junction to ambient thermal resistance measured in a one cubic foot sealed enclosure. θ_{JC} is the junction to case thermal resistance.

Table 3. Package Characteristics

Package Type	θ_{JA}	θ_{JC}	Unit
CC-14-1 ¹	150	85	°C/W

¹ Thermal impedance simulated values are based on JEDEC 2S2P thermal test board. See JEDEC JESD-51.

ESD CAUTION



ESD (electrostatic discharge) sensitive device. Charged devices and circuit boards can discharge without detection. Although this product features patented or proprietary protection circuitry, damage may occur on devices subjected to high energy ESD. Therefore, proper ESD precautions should be taken to avoid performance degradation or loss of functionality.

PIN CONFIGURATION AND FUNCTION DESCRIPTIONS

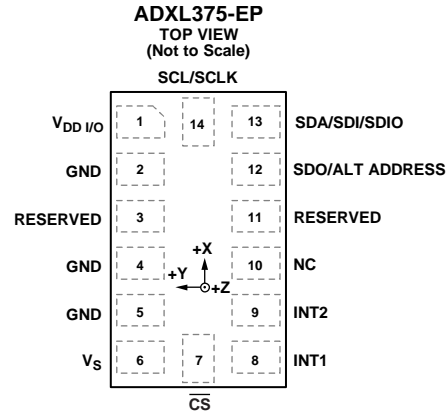

NOTES
1. NC = NOT INTERNALLY CONNECTED.

16895-002

Figure 2. Pin Configuration

Table 4. Pin Function Descriptions

Pin No.	Mnemonic	Description
1	$V_{DD\ I/O}$	Digital Interface Supply Voltage.
2	GND	Ground. This pin must be connected to ground.
3	RESERVED	Reserved. This pin must be connected to V_S or left open.
4	GND	Ground. This pin must be connected to ground.
5	GND	Ground. This pin must be connected to ground.
6	V_S	Supply Voltage.
7	\overline{CS}	Chip Select.
8	INT1	Interrupt 1 Output.
9	INT2	Interrupt 2 Output.
10	NC	Not Internally Connected.
11	RESERVED	Reserved. This pin must be connected to ground or left open.
12	SDO/ALT ADDRESS	SPI 4-Wire Serial Data Output (SDO)/I ² C Alternate Address Select (ALT ADDRESS).
13	SDA/SDI/SDIO	I ² C Serial Data (SDA)/SPI 4-Wire Serial Data Input (SDI)/SPI 3-Wire Serial Data Input and Output (SDIO).
14	SCL/SCLK	I ² C Serial Communications Clock (SCL)/SPI Serial Communications Clock (SCLK).

TYPICAL PERFORMANCE CHARACTERISTICS

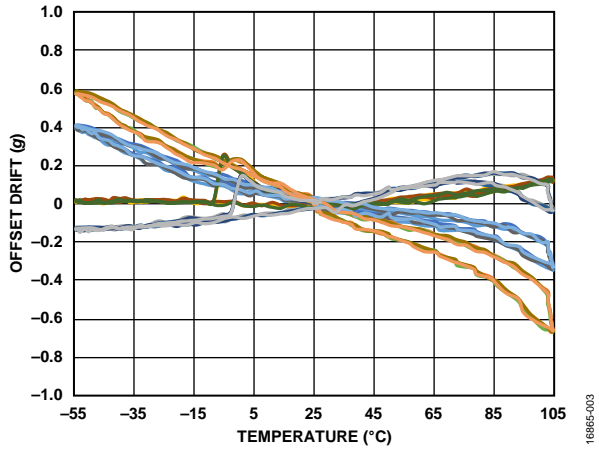

Figure 3. X-Axis Offset Drift, 15 Devices Soldered to PCB, $V_S = 2.5\text{ V}$

16865-003

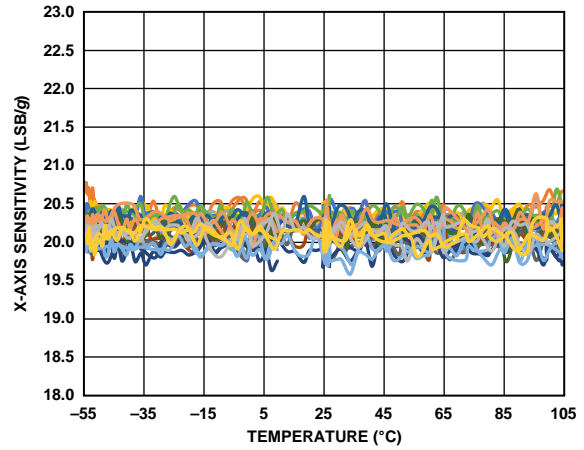

Figure 6. X-Axis Sensitivity vs. Temperature, 15 Devices Soldered to PCB, $V_S = 2.5\text{ V}$

16865-006

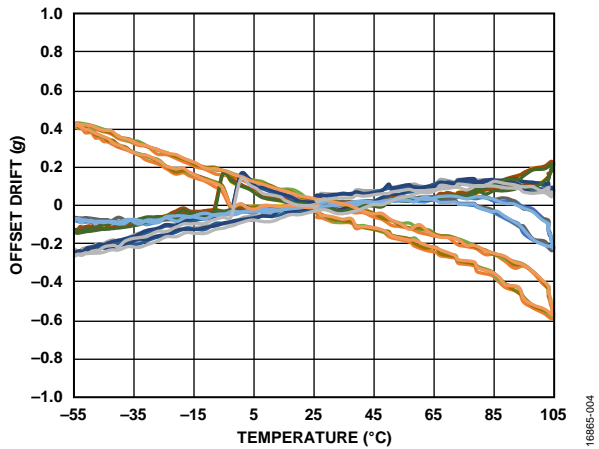

Figure 4. Y-Axis Offset Drift, 15 Devices Soldered to PCB, $V_S = 2.5\text{ V}$

16865-004

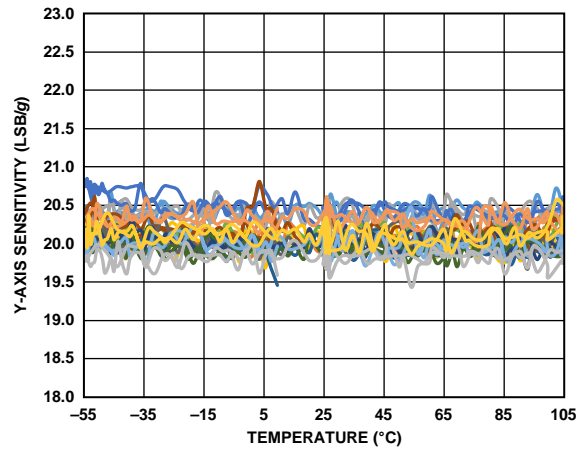

Figure 7. Y-Axis Sensitivity vs. Temperature, 15 Devices Soldered to PCB, $V_S = 2.5\text{ V}$

16865-007

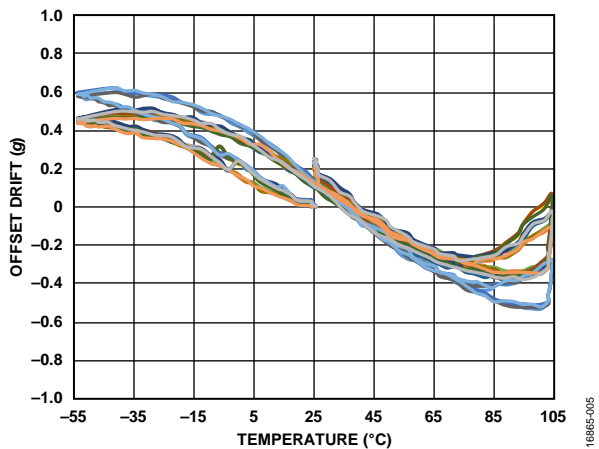

Figure 5. Z-Axis Offset Drift, 15 Devices Soldered to PCB, $V_S = 2.5\text{ V}$

16865-005

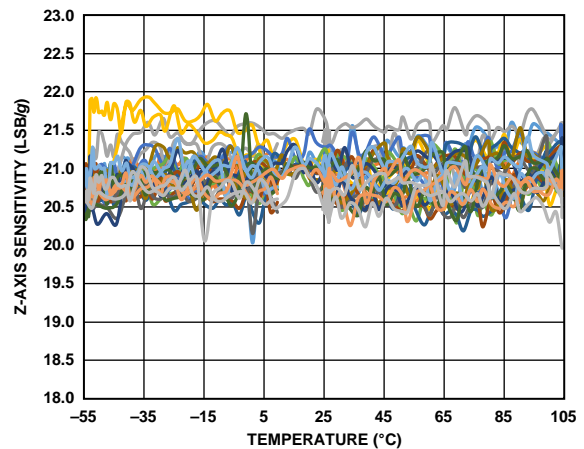

Figure 8. Z-Axis Sensitivity vs. Temperature, 15 Devices Soldered to PCB, $V_S = 2.5\text{ V}$

16865-008

OUTLINE DIMENSIONS

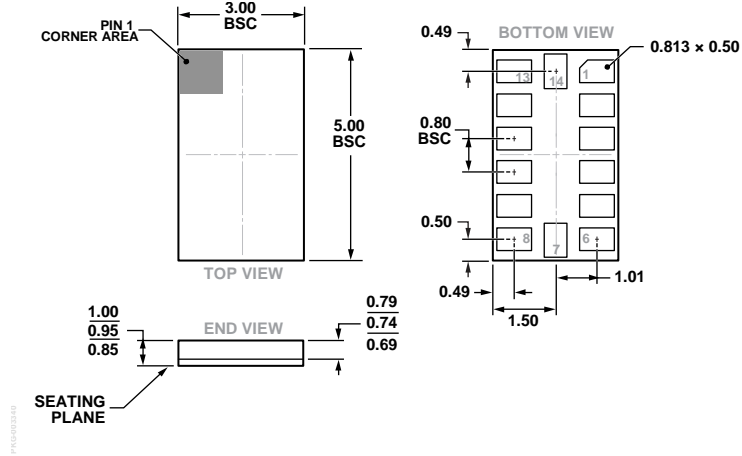

Figure 9. 14-Terminal Land Grid Array [LGA]
(CC-14-1)
Dimensions shown in millimeters

ORDERING GUIDE

Model ¹	Temperature Range	Measurement Range (g)	Specified Voltage (V)	Package Description	Package Option
ADXL375SCCZ-EP	-55°C to +105°C	±200	2.5	14-Terminal Land Grid Array [LGA]	CC-14-1
ADXL375SCCZ-EP-RL7	-55°C to +105°C	±200	2.5	14-Terminal Land Grid Array [LGA]	CC-14-1

¹ Z = RoHS Compliant Part.

I²C refers to a communications protocol originally developed by Philips Semiconductors (now NXP Semiconductors).

©2018 Analog Devices, Inc. All rights reserved. Trademarks and registered trademarks are the property of their respective owners.
D16865-0-7/18(0)



www.analog.com