

TZY2Z030AC01R00

Discontinued

RoHS

REACH

Appearance & Shape

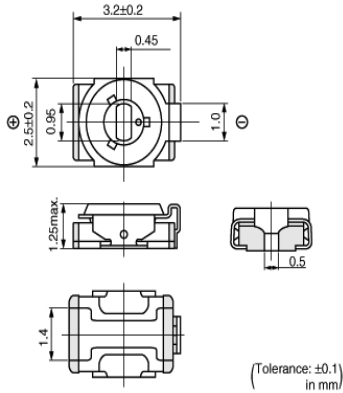
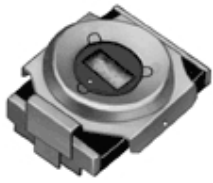

Features

1. Small and thin size with external dimensions of $2.5(W) \times 3.2(L) \times 1.25 \text{max}(H)$ mm.
2. New shape of cover can improve the flux invasion compared with current products.
3. Improvement of the adhesion between rotor and stator leads to superior stability.
4. Unique construction with no plastic material provides superior soldering heat resistance to maintain excellent characteristic performance after reflow soldering.

Packaging Information

Packaging	Specifications	Standard Packing Quantity
R00	180mm Embossed Tape	2000

Attention

1.This datasheet is downloaded from the website of Murata Manufacturing Co., Ltd. Therefore, it's specifications are subject to change or our products in it may be discontinued without advance notice. Please check with our sales representatives or product engineers before ordering.

2.This datasheet has only typical specifications because there is no space for detailed specifications.

Therefore, please review our product specifications or consult the approval sheet for product specifications before ordering.

TZY2Z030AC01R00



Specifications

Shape	SMD
Operating Temperature Range	-25°C to 85°C
Thickness	1.25mm
Thickness Tolerance	max.
Rated Voltage	25Vdc
Cmin.(max.)	1.5pF
Cmax.	3pF
Cmax. Tolerance	+100/-0%
Adjustment Direction	Top
TC	NP0±300ppm/°C
Q	300min. at 1MHz, Cmax.
Withstanding Voltage	55Vdc
Insulation Resistance(min.)	10000MΩ
Torque	0.7 to 4.9mNm
Mass	0.032g

Attention

1.This datasheet is downloaded from the website of Murata Manufacturing Co., Ltd. Therefore, it's specifications are subject to change or our products in it may be discontinued without advance notice. Please check with our sales representatives or product engineers before ordering.

2.This datasheet has only typical specifications because there is no space for detailed specifications.

Therefore, please review our product specifications or consult the approval sheet for product specifications before ordering.

TZY2Z030AC01R00

Product Data

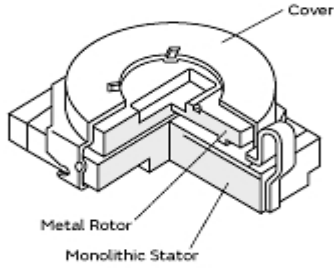

Constructions

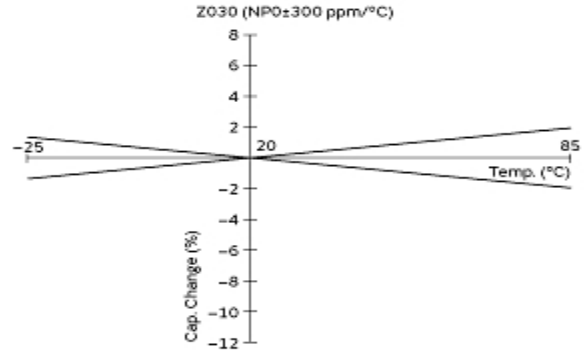

Temp. Coeff. Characteristics

Attention

- 1.This datasheet is downloaded from the website of Murata Manufacturing Co., Ltd. Therefore, it's specifications are subject to change or our products in it may be discontinued without advance notice. Please check with our sales representatives or product engineers before ordering.
- 2.This datasheet has only typical specifications because there is no space for detailed specifications.
Therefore, please review our product specifications or consult the approval sheet for product specifications before ordering.