

C3216C0G2J822K160AA

TDK Item Description : C3216C0G2J822KT****



Application & Main Feature

Commercial Grade (Mid Voltage (100 to 630V))

Series

C3216 [EIA CC1206]

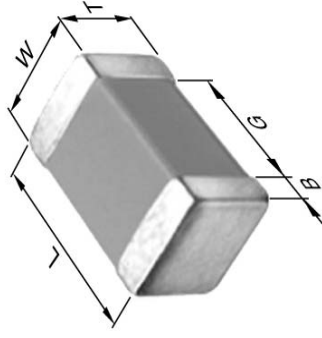

Dimensions

L	3.20mm	+/-0.2mm
W	1.60mm	+/-0.2mm
T	1.60mm	+/-0.2mm
B	0.20mm	Min.
G	1.00mm	Min.

Temperature Characteristic

C0G (-55 to 125 degC 0+/-30ppm/degC)

Rated Voltage

2J (630Vdc)

Capacitance

8.2nF

Capacitance Tolerance

K (+/-10%)

Q Factor

1000 Min.

Insulation Resistance

10Gohm Min.

AEC-Q200

Not Applicable

|Z|, ESR vs. Freq. Characteristics

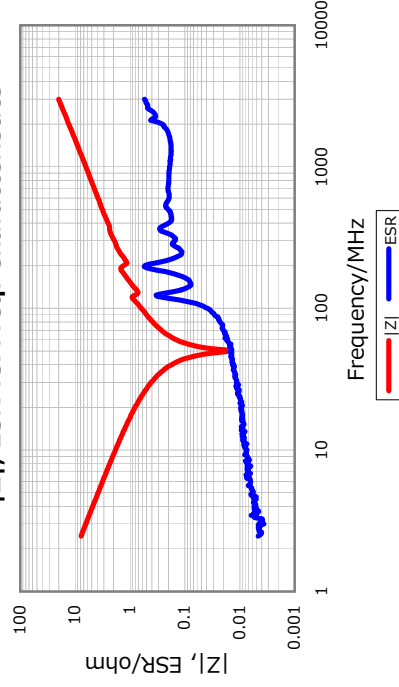

DC Bias Characteristic

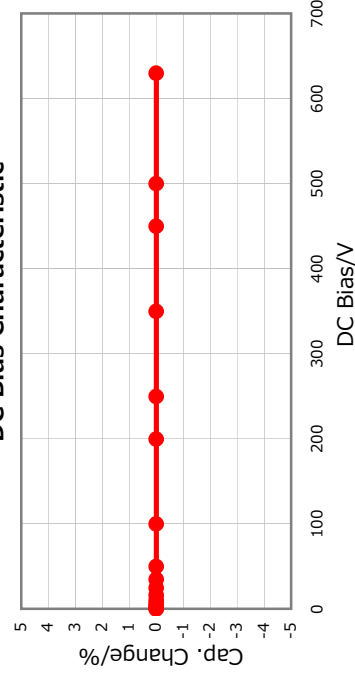

Cap. vs. Freq. Characteristic

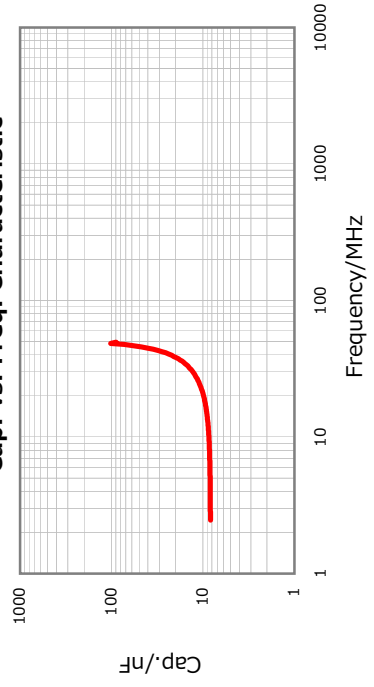

Temperature Characteristics

