



FEATURES

- RoHS compliant
- 0.28μH to 1.0mH
- Up to 8.7A I_{DC}
- Bobbin format
- Surface mount
- Integral EMI shield
- Compact size
- Tape and reel packaging
- UL 94V-0 materials
- J-STD-020-C reflow

DESCRIPTION

The 4600 series is a range of bobbin-wound, shielded inductors suitable for power-line filtering found in consumer electronics such as desktop computers, LED applications and GPS systems, as well as in a vast range of industrial and telecom applications including network hubs, bridges & routers, and high frequency wireless communication devices.

These surface mount inductors are extremely compact and have an integral shield, making them useful in EMI sensitive applications.

PIN CONNECTIONS (TOP VIEW)

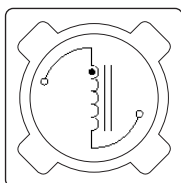

SELECTION GUIDE

Order Code	Inductance (10kHz, 0.1V _{AC}) ±20%	DC Current ¹		DC Resistance
	Nom.	Max.	Max.	
	μH	A	mΩ	
46281C	0.28 (±30%)	8.7	8	
46541C	0.54 (±30%)	7.7	10	
46102C	1.0 (±30%)	6.8	13	
46152C	1.5 (±30%)	6.3	15	
46222C	2.2 (±30%)	5.0	21	
46332C	3.3 (±30%)	4.3	29	
46472C	4.7 (±30%)	3.7	37	
46682C	6.8 (±30%)	3.1	52	
46103C	10	2.4	66	
46153C	15	2.2	94	
46223C	22	1.8	120	
46333C	33	1.45	190	
46473C	47	1.25	260	
46683C	68	1.05	360	
46104C	100	0.86	500	
46154C	150	0.72	720	
46224C	220	0.57	1050	
46334C	330	0.46	1850	
46474C	470	0.39	2800	
46684C	680	0.32	3900	
46105C	1000	0.27	4900	

MECHANICAL DIMENSIONS

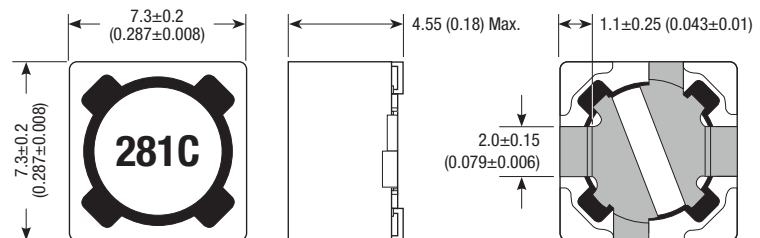

Recommended Footprint Details*

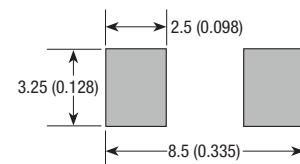

*Distance between the outside ends of the terminations is 7.1±0.1 (0.28±0.004)
Unless otherwise stated, all dimensions in mm (inches) ± 0.25 (0.010).
Package weight: 0.8g Typ.

ABSOLUTE MAXIMUM RATINGS

Operating temperature range	-40°C to 125°C
Storage temperature range	-40°C to 150°C

SOLDERING INFORMATION²

Peak reflow solder temperature	250°C
Pin finish	Tin

Specifications typical at T_A = 25°C

- 1 Maximum DC current occurs when either the inductance falls to 75% of its nominal value or when its temperature rise reaches 40°C, whichever is sooner.
- 2 For further information, please visit www.murata-ps.com/rohs



For full details go to
www.murata-ps.com/rohs

INDUCTANCE Vs CURRENT

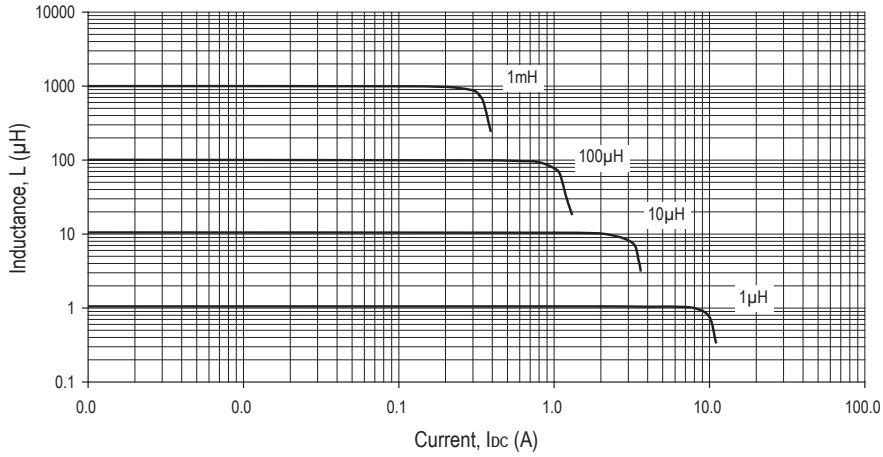

TEMPERATURE Vs CURRENT

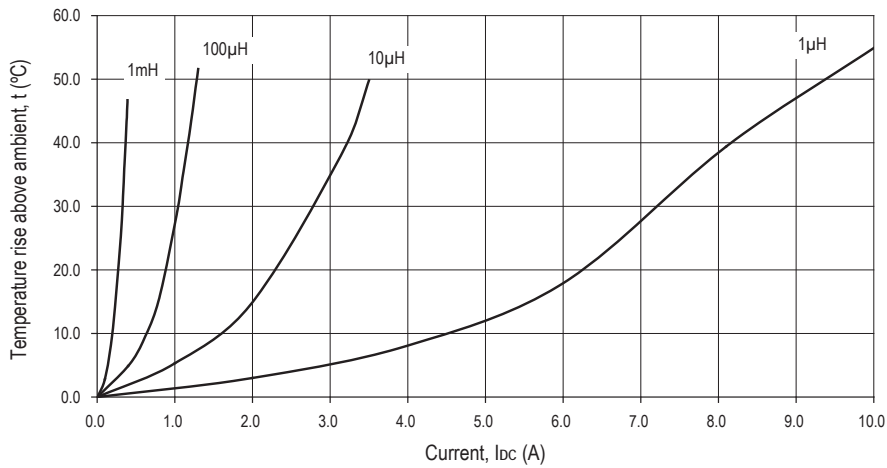

INDUCTANCE Vs FREQUENCY

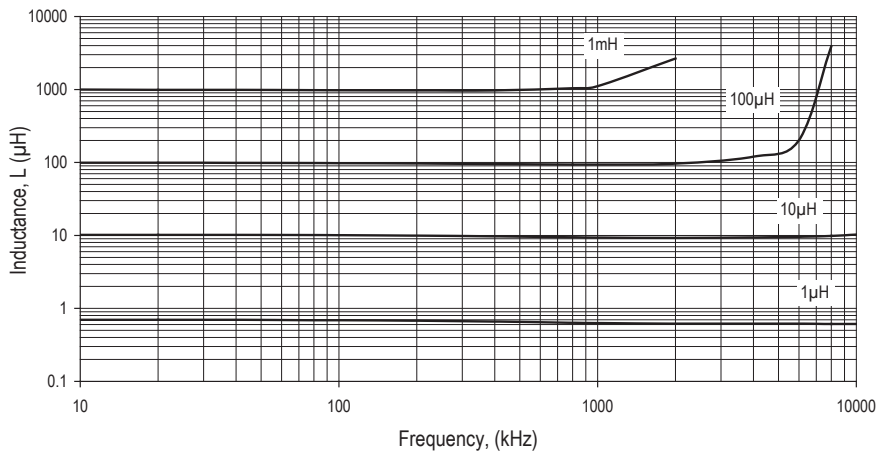

TAPE & REEL SPECIFICATIONS

REEL OUTLINE DIMENSIONS

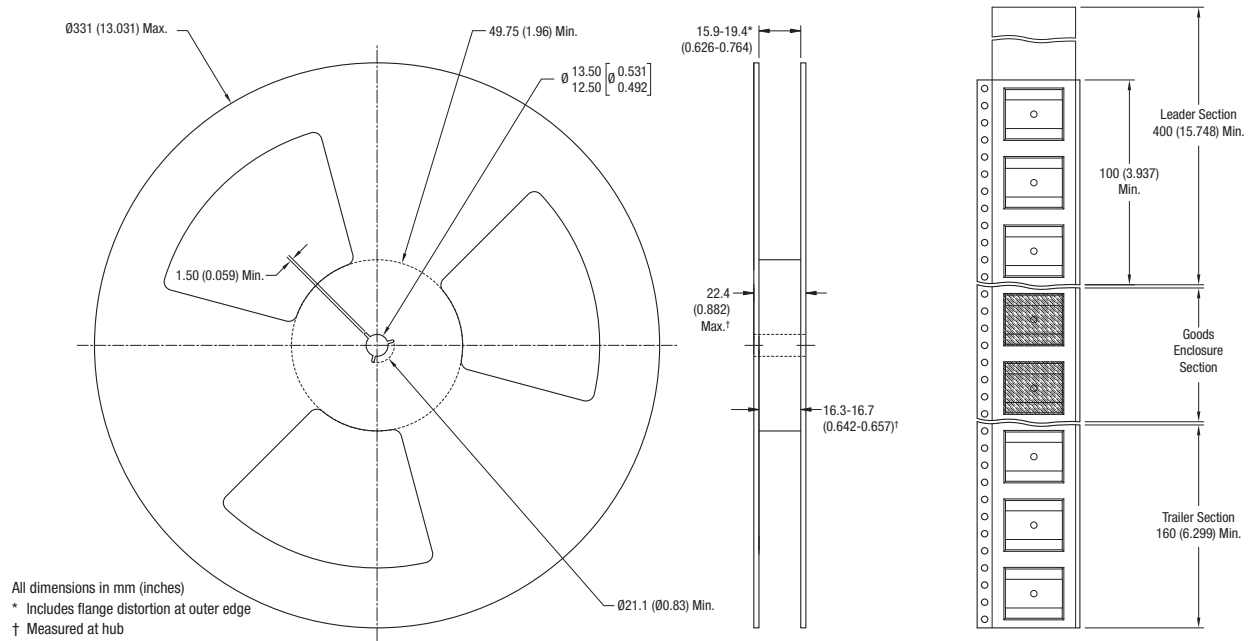

TAPE OUTLINE DIMENSIONS

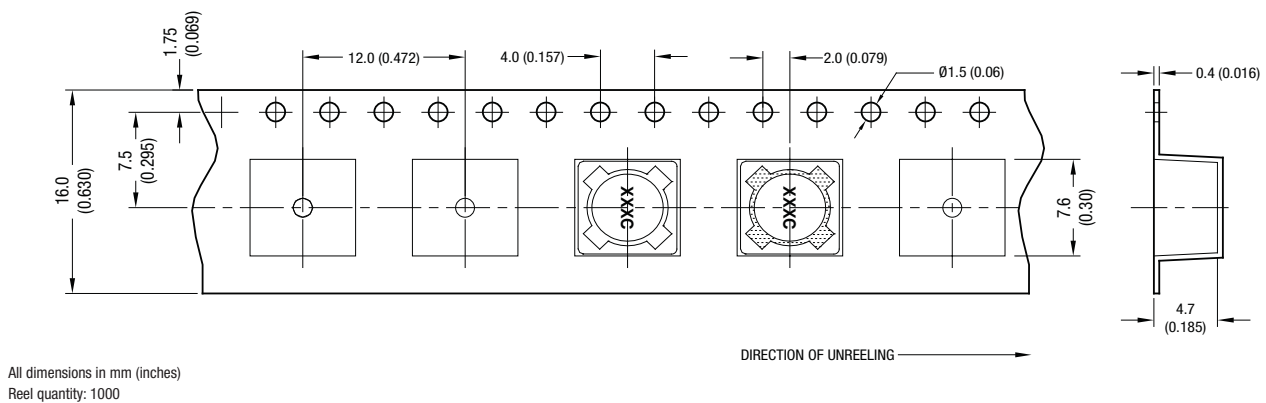

DISCLAIMER

Unless otherwise stated in the datasheet, all products are designed for standard commercial and industrial applications and NOT for safety-critical and/or life-critical applications.

Particularly for safety-critical and/or life-critical applications, i.e. applications that may directly endanger or cause the loss of life, inflict bodily harm and/or loss or severe damage to equipment/property, and severely harm the environment, a prior explicit written approval from Murata is strictly required. Any use of Murata standard products for any safety-critical, life-critical or any related applications without any prior explicit written approval from Murata shall be deemed unauthorised use.

These applications include but are not limited to:

- Aircraft equipment
- Aerospace equipment
- Undersea equipment
- Power plant control equipment
- Medical equipment
- Transportation equipment (automobiles, trains, ships, etc.)
- Traffic signal equipment
- Disaster prevention / crime prevention equipment
- Data Processing equipment

Murata makes no express or implied warranty, representation, or guarantee of suitability, fitness for any particular use/purpose and/or compatibility with any application or device of the buyer, nor does Murata assume any liability whatsoever arising out of unauthorised use of any Murata product for the application of the buyer. The suitability, fitness for any particular use/purpose and/or compatibility of Murata product with any application or device of the buyer remain to be the responsibility and liability of the buyer.

Buyer represents and agrees that it has all the necessary expertise to create and implement safeguards that anticipate dangerous consequences of failures, monitor failures and their consequences, lessen the likelihood of failures that might cause harm, and take appropriate remedial actions. Buyer will fully indemnify and hold Murata, its affiliated companies, and its representatives harmless against any damages arising out of unauthorised use of any Murata products in any safety-critical and/or life-critical applications.

Remark: Murata in this section refers to Murata Manufacturing Company and its affiliated companies worldwide including, but not limited to, Murata Power Solutions.



This product is subject to the following **operating requirements** and the **Life and Safety Critical Application Sales Policy**:

Refer to: <https://www.murata.com/en-eu/products/power/requirements>

Murata Power Solutions (Milton Keynes) Ltd. makes no representation that the use of its products in the circuits described herein, or the use of other technical information contained herein, will not infringe upon existing or future patent rights. The descriptions contained herein do not imply the granting of licenses to make, use, or sell equipment constructed in accordance therewith. Specifications are subject to change without notice.

© 2021 Murata Power Solutions (Milton Keynes) Ltd.