

# CGA2B2C0G1H270J050BD

TDK Item Description : CGA2B2C0G1H270JT\*\*\*B



Equivalent C1005C0G1H270J for Automotive

## Application & Main Feature

Automotive Grade ( Conductive Epoxy Application )

## Series

CGA2(1005) [EIA CC0402]

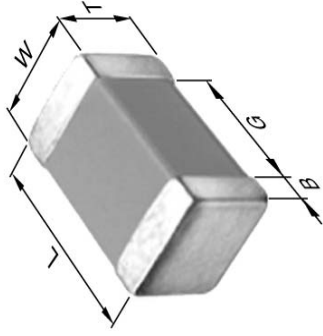

## Dimensions

L	1.00mm	+/-0.15mm
W	0.50mm	+/-0.1mm
T	0.50mm	+/-0.1mm
B	0.10mm	Min.
G	0.30mm	Min.

## Temperature Characteristic

C0G (-55 to 125 degC 0+/-30ppm/degC)

## Rated Voltage

1H (50Vdc)

## Capacitance

27pF

## Capacitance Tolerance

J (+/-5%)

## Q Factor

940 Min.

## Insulation Resistance

10Gohm Min.

## AEC-Q200

Yes

## |Z|, ESR vs. Freq. Characteristics

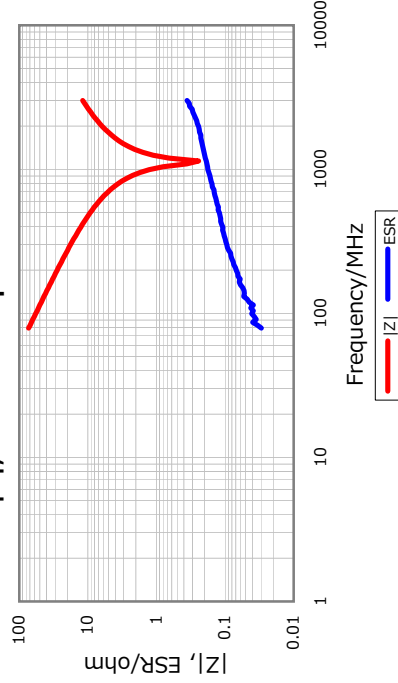

## DC Bias Characteristic

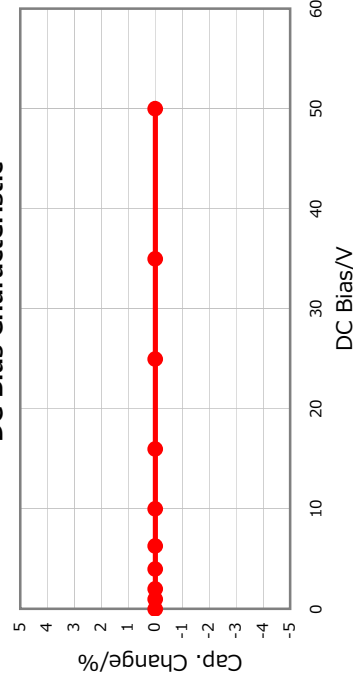

## Cap. vs. Freq. Characteristic

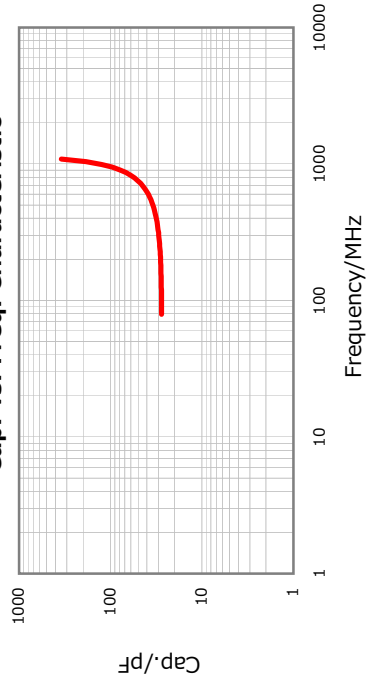

## Temperature Characteristics

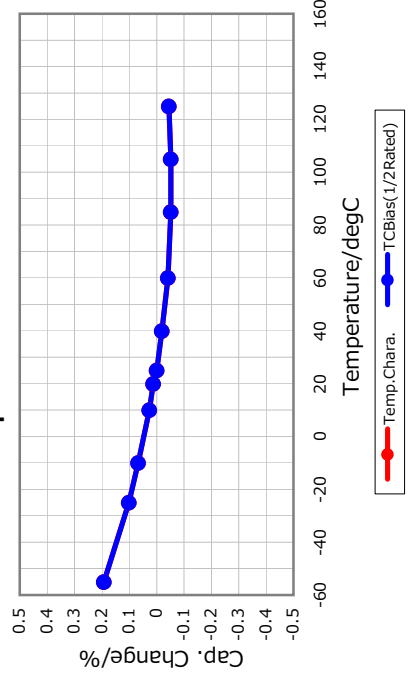

⚠ All specifications are subject to change without notice.

January 4, 2016