

C1608X5R2A153M080AA

TDK Item Description : C1608X5R2A153MT****



Application & Main Feature

Commercial Grade (Mid Voltage (100 to 630V))

Series

C1608 [EIA CC0603]

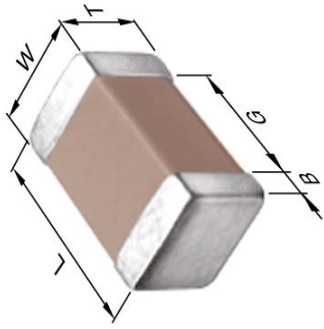

DC Bias Characteristic

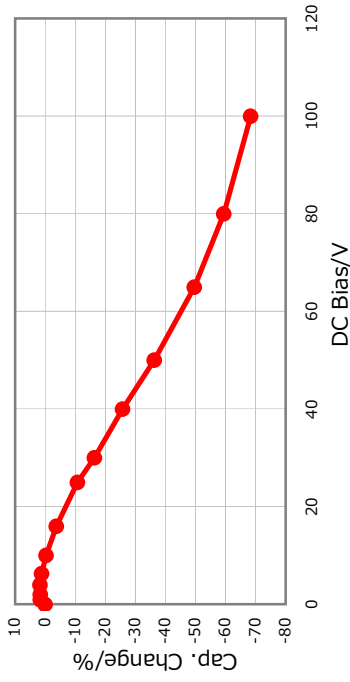

|Z|, ESR vs. Freq. Characteristics

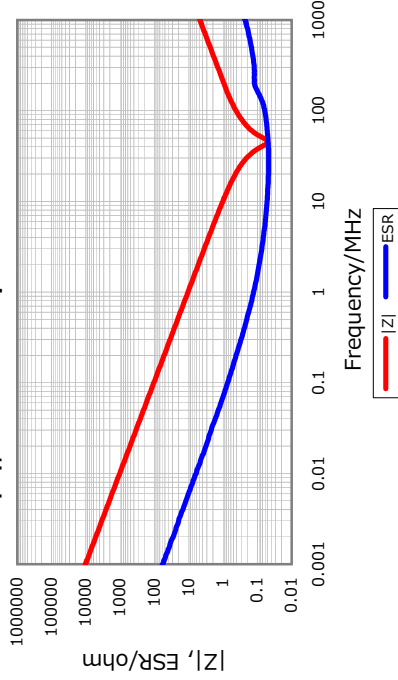

Temperature Characteristic

X5R (-55 to 85 degC +/-15%)

Rated Voltage

2A (100Vdc)

Capacitance

15nF

Capacitance Tolerance

M (+/-20%)

Dissipation Factor

3% Max.

Insulation Resistance

10Gohm Min.

AEC-Q200

Not Applicable

Temperature Characteristics

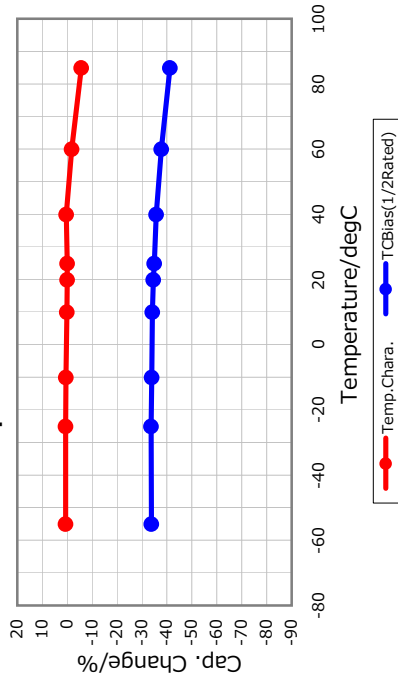

Ripple Temperature Rise Characteristics

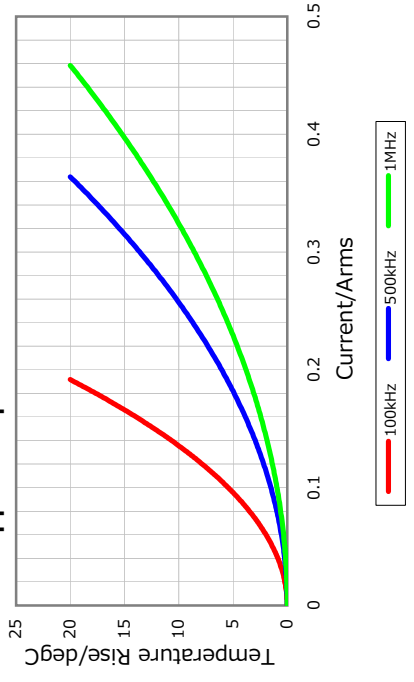

Cap. vs. Freq. Characteristic

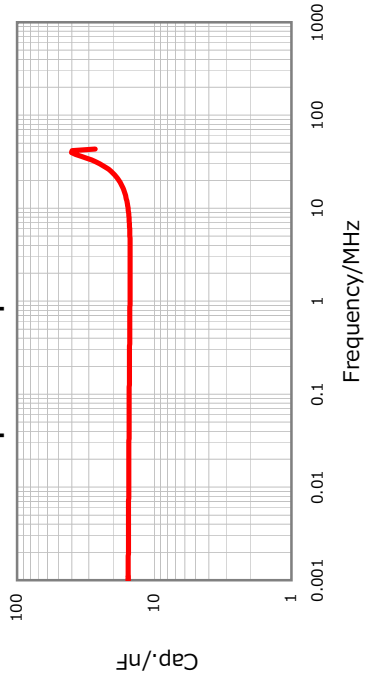

All specifications are subject to change without notice.

January 3, 2016