

DSS1NB32A332Q55#

“#” indicates a package specification code.

In Production

RoHS

REACH

< List of part numbers with package codes >

DSS1NB32A332Q55B

Appearance & Shape

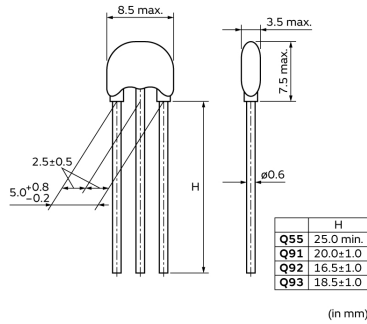

Features

DSS1 series is a compact, high performance lead type 3 terminal capacitor which can be mounted in 2.54mm pitch.
Its three terminal structure enables nice high frequency performance.
Wide capacitance variation enables flexible selection for various noise frequencies.
High speed mounting is available with automatic insertion machine.

Applications

Other Usage	For general
-------------	-------------

Packaging Information

Packaging	Specifications	Standard Packing Quantity
B	Bulk(Bag)	250

Attention

- 1.This datasheet is downloaded from the website of Murata Manufacturing Co., Ltd. Therefore, it's specifications are subject to change or our products in it may be discontinued without advance notice. Please check with our sales representatives or product engineers before ordering.
- 2.This datasheet has only typical specifications because there is no space for detailed specifications. Therefore, please review our product specifications or consult the approval sheet for product specifications before ordering.

DSS1NB32A332Q55#

“#” indicates a package specification code.

Specifications

Shape	Lead
Length	8.5mm
Length Tolerance	max.
Width	3.5mm
Width Tolerance	max.
Thickness	7.5mm
Thickness Tolerance	max.
Rated Current	6A
Operating Temperature Range	-40°C to 85°C
Mass(typ.)	0.45g
Number of Circuit	1
Insulation Resistance(min.)	1000MΩ
Rated Voltage	100Vdc
Withstanding Voltage	250Vdc
Capacitance	3300pF
Capacitance Tolerance	±10%
Structure/Shape	Small type beads inside (straight)

Attention

- 1.This datasheet is downloaded from the website of Murata Manufacturing Co., Ltd. Therefore, it's specifications are subject to change or our products in it may be discontinued without advance notice. Please check with our sales representatives or product engineers before ordering.
- 2.This datasheet has only typical specifications because there is no space for detailed specifications. Therefore, please review our product specifications or consult the approval sheet for product specifications before ordering.

DSS1NB32A332Q55#

“#” indicates a package specification code.

Product Data

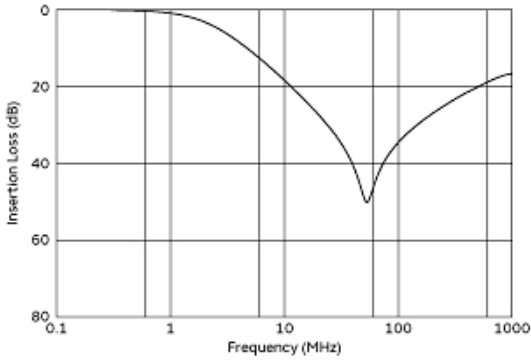

Insertion Loss Characteristics

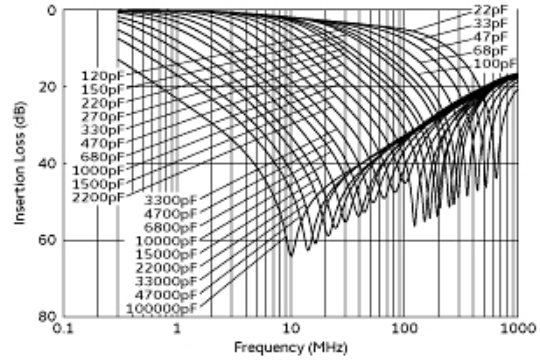

Insertion Loss Characteristics (Main Items)

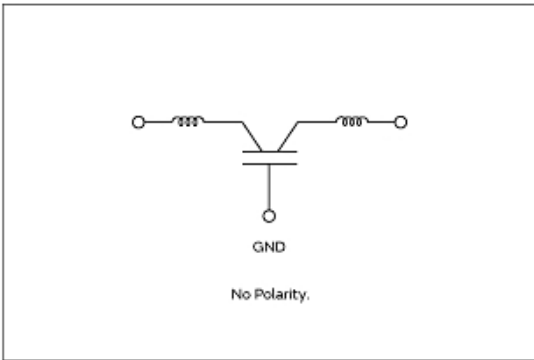

Equivalent Circuit

Attention

- 1.This datasheet is downloaded from the website of Murata Manufacturing Co., Ltd. Therefore, it's specifications are subject to change or our products in it may be discontinued without advance notice. Please check with our sales representatives or product engineers before ordering.
- 2.This datasheet has only typical specifications because there is no space for detailed specifications. Therefore, please review our product specifications or consult the approval sheet for product specifications before ordering.