

CGA3E2NP02A821J080AA

TDK Item Description : CGA3E2NP02A821JT*****

Equivalent C1608NP02A821J for Automotive

Application & Main Feature

Automotive Grade (High Temperature Application)

Series

CGA3(1608) [EIA CC0603]

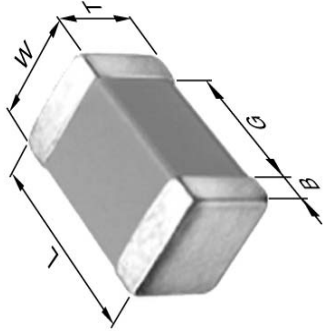

Dimensions

L	1.60mm	+/-0.1mm
W	0.80mm	+/-0.1mm
T	0.80mm	+/-0.1mm
B	0.20mm	Min.
G	0.30mm	Min.

Temperature Characteristic

NP0 (-55 to 150 degC 0+/-30ppm/degC)

Rated Voltage

2A (100Vdc)

Capacitance

820pF

Capacitance Tolerance

J (+/-5%)

Q Factor

1000 Min.

Insulation Resistance

10Gohm Min.

AEC-Q200

Yes

|Z|, ESR vs. Freq. Characteristics

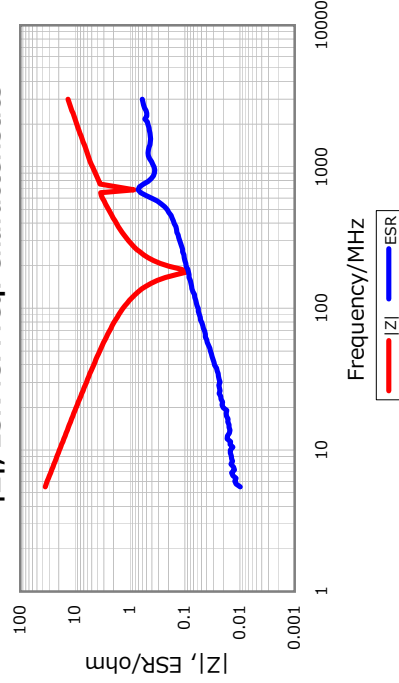

DC Bias Characteristic

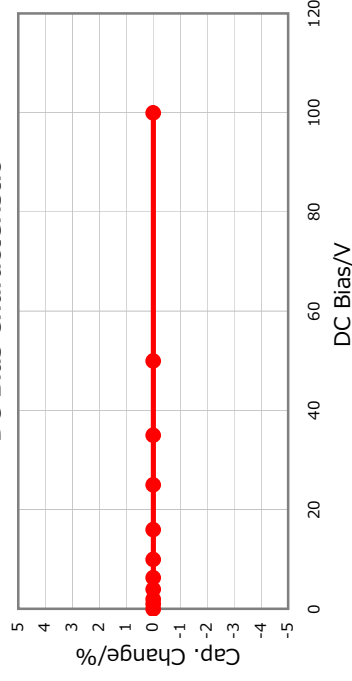

Cap. vs. Freq. Characteristic

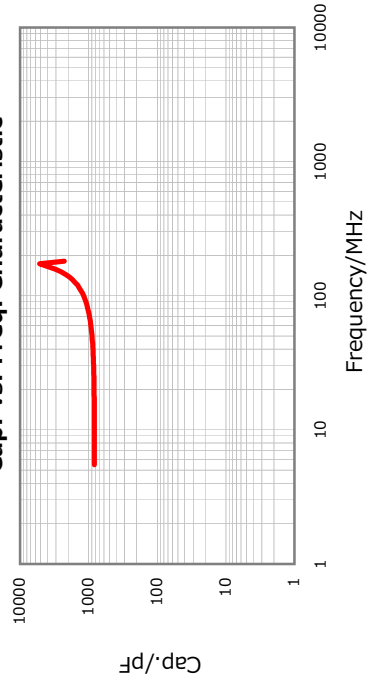

Temperature Characteristics

